

AWWAJUN

Ijunja unuimajagmi

4

Uchi 4 mijan ajamu takastin

La ciudadana y el ciudadano que queremos

Desarrolla procesos autónomos de aprendizaje.

Se **reconoce** como persona valiosa y se identifica con su cultura en diferentes contextos.

Gestiona proyectos de manera ética.

Interpreta la realidad y toma decisiones con conocimientos matemáticos.

Propicia la vida en democracia comprendiendo los procesos históricos y sociales.

Indaga y comprende el mundo natural y artificial utilizando conocimientos científicos en diálogo con saberes locales.

Perfil de egreso

Se **comunica** en su lengua materna, en castellano como segunda lengua y en inglés como lengua extranjera.

Aprovecha responsablemente las tecnologías.

Comprende y aprecia la dimensión espiritual y religiosa.

Aprecia manifestaciones artístico-culturales y crea proyectos de arte.

Practica una vida activa y saludable.

Currículo
N a c i o n a l



Ijunja unuimajagmi

4

Uchi 4 mijan ajamu takastin



Ministerio de Educación

Dirección General de Educación Básica Alternativa, Intercultural Bilingüe
y de Servicios Educativos en el Ámbito Rural

Dirección de Educación Intercultural Bilingüe

Ijunja Unuimajagmi
Cuaderno de trabajo y folder - inicial 4 años Awajún

©Ministerio de Educación
Av. De la Arqueología cuadra 2, San Borja
Lima, Perú
Teléfono: 615-5800
www.gob.pe/minedu

Cuarta edición, 2020
Tiraje: 4549 ejemplares
Impreso en enero 2021

Elaboración de contenido

Nancy Ismiño Velarde

Revisión de contenido

Claudio Wampuch Bitap, Ramon Nampag Esamat
Angela Majuash Ukuncham, Lady Akintui Tsajuput

Revisión lingüística

Claudio Wampuch Bitap, Ramon Nampag Esamat
Angela Majuash Ukuncham, Lady Akintui Tsajuput

Asesoría y revisión técnica (Digeibira-DEIB)

Martha Morales Quiróz
Bertha Liliana Pacheco Díaz

Ilustraciones

Piero Bejarano Scamarone
Archivo Digeibira-DEIB

Diseño y diagramación

César Adolfo Yeckle Castro

Cuidado de la edición

Martha Morales Quiroz

Se terminó de imprimir en enero de 2021 en:
Gráfica Biblos S.A.
Calle Morococha 152 - Surquillo

Hecho el Depósito Legal en la Biblioteca Nacional del Perú
N° 2020 - 10156

Este material no se puede reproducir total ni parcialmente
sin el permiso expreso de los editores.

Impreso en el Perú , *Printed in Peru*



Iwainamu

Uchuch nuwauch, aishmag aidau.

Juti unuimatjin jetemjin Dirección General de Educación Básica Alternativa, Intercultural Bilingüe y de servicios Educativos en el Ámbito Rural – DIGEIBIRA del Ministerio de Educación "Eme anenjamás, papi takaku unuimatain, atumin uwegmin idaitugmawai. Kumpagmijai ijunjajum, jintinkagtinjai, nuwigtush pataim aidau, yaimpakmatai shiig wakejusjum unuimagtatjuwe "

Papijum takakum shig wakejusjum wainkattajume atumin batsamtaijum, nuniakum dekattajume pataim eme anentsa diit, antsamek ikamjumesh ajantusa diyakum, kuwitamsa takat unuimagtatjume.

Muunta chichame antakjum unuimagtatjume, tajimat pujut, tikich pataim aidaujai.

Aniaku, atuunika egakagmi, ashi ijunja waitkas batsamain.

Takat papiigmin umikbau takakjum shiig dakunkut unuimagtatjume: wasugkamat, ejesmamu, dakumu, jakimtikat, nuwigtu wakesa agat. Nunuiakjum ejetatjume atum anentaimtugbau.

¡Junja unuimajagmi!

Glosario

- jakiti= color
- yajimtikat = pintar
- kenu = lápiz
- ichikmaamu = triángulo
- tente = círculo
- tatagmamu = rectangulo
- papi tsupigmaunum dakumjamu = tarjeta
- yujag dakumjamu = ilustración de las frutas.
- dakumjamu = figura
- ijunja takastin = grupo de trabajo
- niime =imagen
- tsentsakam achimtikata = une con una línea
- pusut = punto
- papi muun wegkajam = papelote
- dakumkagtamu = dramatizar
- dakumjamu anuja emamu = secuencia de imágenes
- takatai = hoja de trabajo
- tsuwamjamu = limpio
- dakumjamu = silueta
- dekatkau= primero
- patatkau = segundo
- nuwi patatkau = tercero
- yagkuatin = durante la semana
- púkuts = suave, blando
- yapinum atektumtai = máscara
- tewa = pelota
- dakumjamu pachimjamu = rompecabeza

Dakúmamkam,
dáaujum agagta







Yujag juwaamu



Daag:

Ikamia yujag juwaamu

Jintinkagtin ujamau

Jintinkagtin muuntan asaukaji tikiju ajamunum uchijai yujag juukmi tusa wenawai.

Muun asaughtin uchin ujawai wajiyai yujagkesh jutaiyaita.

Tuja inak juwakuish wajuktaiyaita dukuji wakanjun jujuki tusaish, nuwigtush shiig tsamaku mamikia juuka yuwamatasais.

Muun yaki waka yujagken tsujig akaketai uchi aidau juki ijumainawai.

Muun asaukagtin uchin ijumag ujawai yujag tsamaku diisa etegja batsatan.

Wajuk muun jintiame nuna adeajag uchi aidau yujagken etegkeg batsainawai.

Papii augtainum tawan, iniimaun aimainawai:

- Wajuk muuntash yaigmaji.
- Ame anegtaimsamesh, ashi yujag aidaush betekash juutaiyait.
- Wanka yujag juwakjish sametbaush juushtaiyaita.

Jintinkagtin, uchin ujawai yakii ainawa tikichish yujag yuidaush.

Yaa yaimainawa

Muun asaukagtin.

Tuwi takanua

Asauk dekatkaunum.

Dakumkata ikamia yujag juwamunmash wajuk yaimkamume.



Three horizontal dashed lines for writing, positioned to the right of the girl's illustration.



Daag:

Yujag juwaamu wasugkamami

Jintinkagtin ujamau

uchi audau, yujag juwaku wekaesamujin aneajag, augmatainawe.

Jintinkagtin anujui, yujag dakumka tsupikmaun; numimum nuu atsutain tanishnum.

Inimui: Wají atsumaji yujag juuktasajish.

Uchi aidau yujag juwaaku takatain adayainawai.

Jintinkagtin iwainawai tsegkenan, chagkinjai.

Nuniak tsegkenjai yujagken tsujig chagkinum enkeawai.

Uchi aidau maki makichik wajakiag, yujagken tsujig chagkinum enkenawai.

yujag tsujigtakama ajuamuk, antsak juwaktatui.

Ayamtainum kaunawag, yujag chagkinum chimpijun, jiinawai. Nuniak inimaum aimainawai.

- Wají yujag aidau juukmaji.
- Wajuk juukmaji.

- Tuwi yujag aidaush aime.
- Tsegkenjai yujag tsujiamush utugchatka.

Ijunja takastin:

Jimag achinikag yujag dakumjamun juinawai; nuniak shiig diisag, betekmamtin ataig apatuk batsainawai.

Yaa yaimainawa

Muun aidau.

Tuwi takanua

Ayamtai agajin.

Waji atsumnawa

Yujag papinum dakumjamu tsupigmbau aidau; yaas (chanag, apu, yaig); apai, inak (apu, yaig); achu (apu, yaig); nuwigtu numi esajam tsegkenjai ayaimu; chagkin

Yujag dakumjamu aidau diisam betekmamtin wainkumek apatkam anujata.



Three horizontal dashed lines for writing, positioned to the right of the girl's illustration.

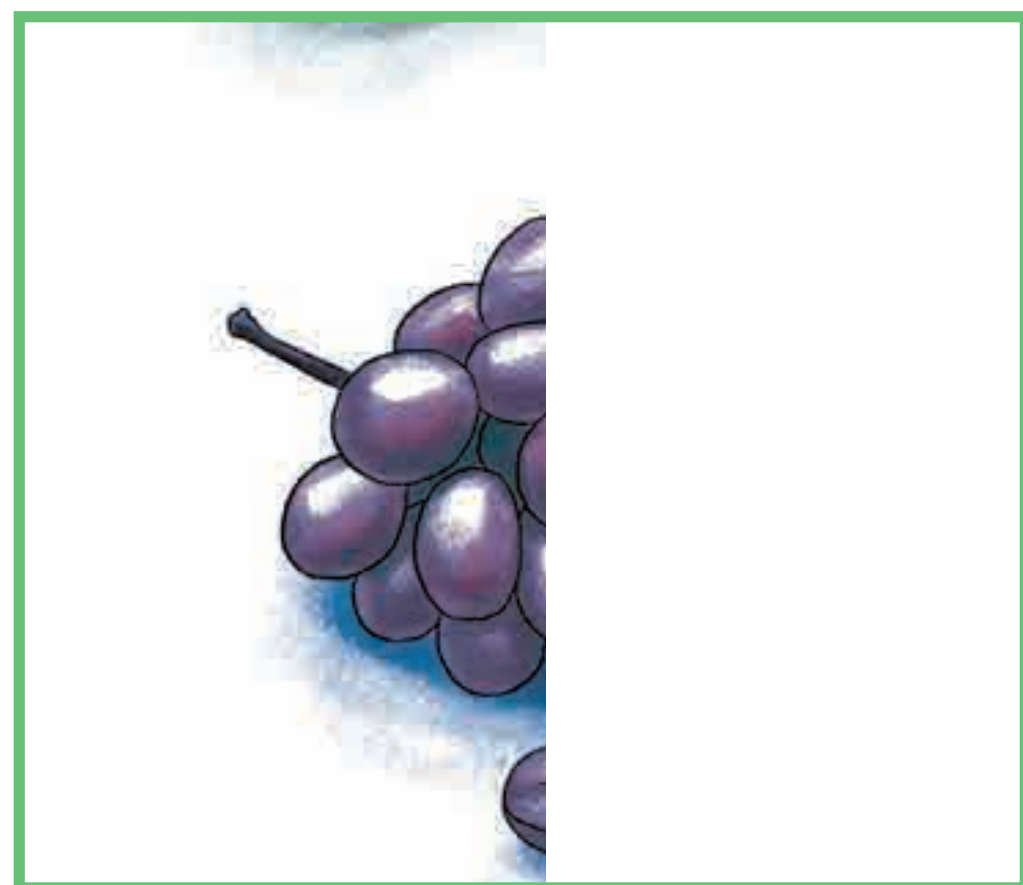
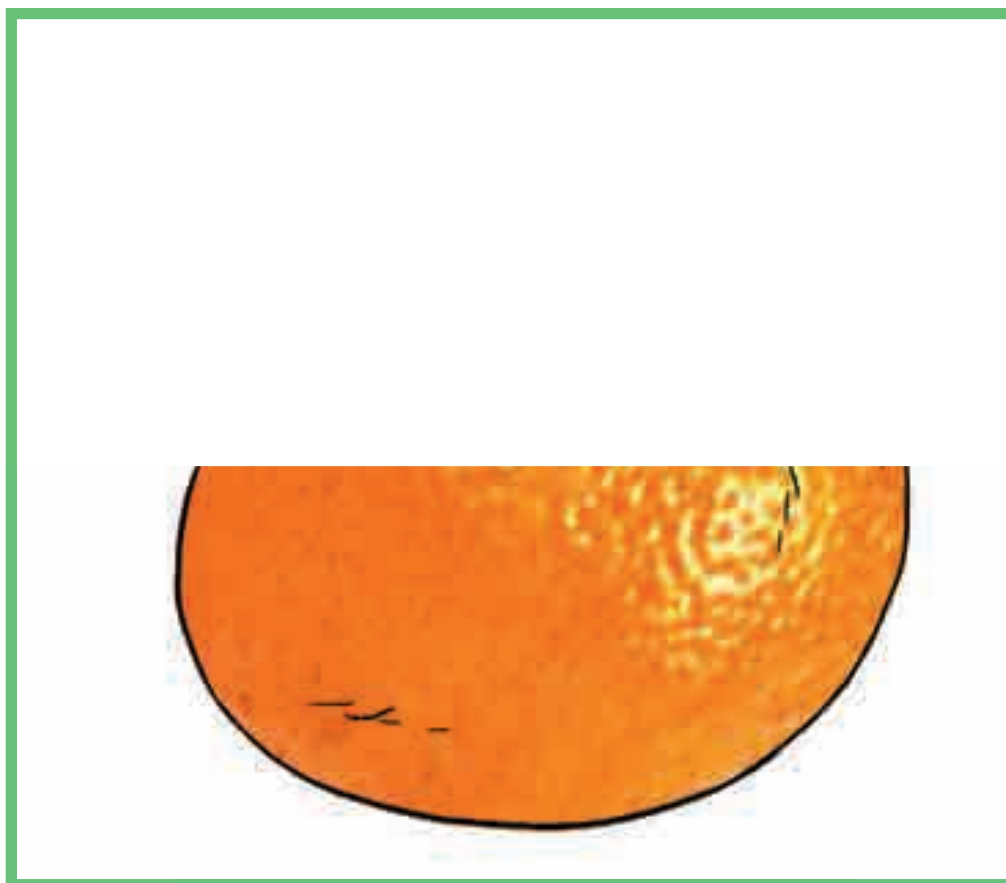
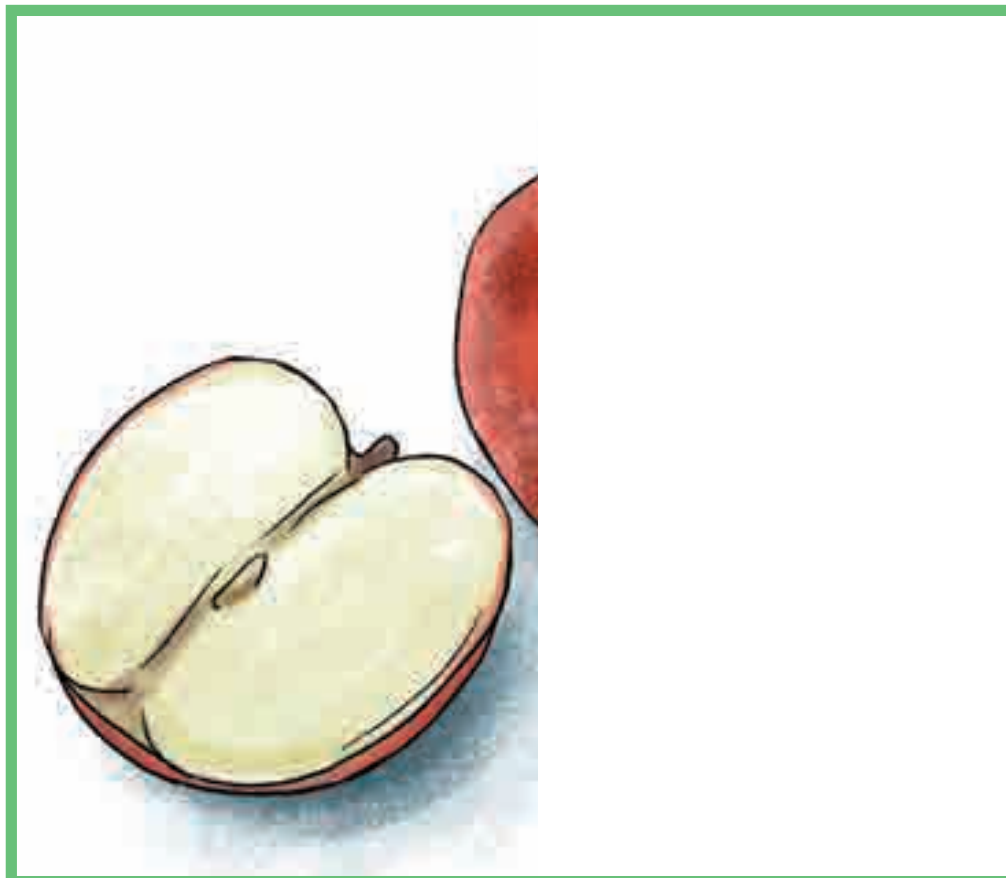

Daag:

Yujag tikich nugkanmaya dekami

Jintinkagtin ujamau

Jintinkagtin, uchi aidaun, yujag tikich nugkagmayan dakumjamun, iwaintawai.

Uchi aidau yujag waintaijin papii tsupikmaujai dukuka ukuawai.

Jintinkagtin uchi aidaun iniawai: yujagke daajish tuu ainawa.

Uchi augmatuinawai yujagken, jakitin, nuwigtu niimen diisag.

Tikich nugkanmaya yujag dakumkamua dusha iinia yujagjai apataka diyamash tujai betekaita.

Jintinkagtin uchin ujawai, juju yujag aina duka, tikich nugkagmaya yutaiyai; nuniu asa, iina nugkenig tikishnan kaunin ainawai tusa.

Antsak uchin ujawai yujagke daajin, nuwigtu wajuku niimesh ainawa.

Yujag capulí tutaig; makichik jigkayi ajinai, shiig yumigtinai, shuwiyajai betekai.

Yujag tuna tutaig; yuminai, saepeg jagkigtinai nuniau asantai kuitamsa pakatia.

Yujag durazno tutaig, yumina, saepeg pukutstchi, makichik jigkayi Bachutjau ajawai. yujag lucuma tutaig, yumiskai, makichik jigkayi pinug wajakin ajawai, neje uyaijai betek wajaknai.

Tinamkata uchi papi takatai S1

Pusut ijuja emamua nunu diisam tsupigta, nuniakum wasugkamtai pachimkamu shiig batsasta.

Waji atsumnawa

Yujag tikich nugkagmaya, dakumja anujamu.

Yujag iina nugkenia dakumja anujamu.

Dakumjamu pachimjamu shiig diisam ikagta.



Three horizontal dashed lines for writing practice.

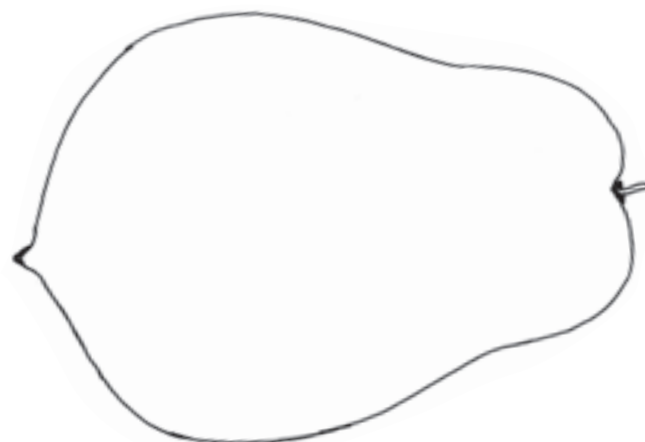
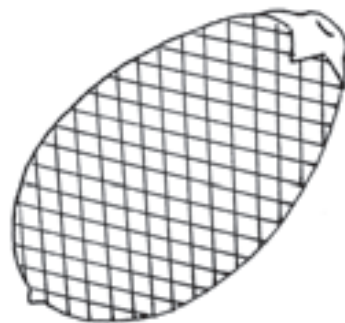

Daag:

Yujag shiig wakejusa yuwami

Jintinkagtin ujamau

Uchi aidau, ikamia yujag ikaunmamun, diinawai.

Yujagken achikag, diisan, etsejuinawai, wajukuita jakitish, kugkutish, nuwigtush yusa dekananak, ijetuinawai, yumiskajin, wakejusa yutaijin.

Antsak, tikich yujag yuwamujin adayainawai.

Uchi aidau diinawai, jintinkagtin, tikich yujag dakumkamu iwainamun.

Uchi nuwaush, antsak aishmagkush aidau, yujag wakesa yutaijin etegkenawai, nuniak augmateinawai wajukukita yujag wakese yutaijish.

Nuna augmatus ukuak, yujag yuchataijin mamikiawai, nuniak augmatui wagka dakitawa nuna.

Egawai, kumpag.mayash, yakii niina yujag wakesa yutaijin, betek ajawa. Igekunkag, chichainawe, wagka amesh juu yujagkesh wakesamesh yuume.

Jintinkagtin, uchi aidaun tinanmui, papii takatain, jakimtijatnujui.

Waji atsumnawa

Jintinkagtin ikaunmattawai: yaas, yumug, wakam, akagnum, kugkuk, kugchai, daum, taperibá.

Ikamia yujag dakumja iwainamu: tauch, inak, shuwiya, sampi, wampa, pau, apai, chimi, kushiwakam.

Ikamia yujag wakesa yutaijum, jakimtikata, nuniakum, kumpajum ujakta wagka wakejusmesh yuume.





Wakejus yujin
ainawai,
niimjuk yagkuwai,
yujuinakug wenin
ajatin wain ainawai.



Wisha yaitja



Anentaimsa adaiyat unuimagmi

Jintinkagtin ujamau

Jintinkagtin, anentaimsa adaitain, uchin
augtawai.

Wakejus yujin ainawai,
niimjuk yagkuwai,
yujuinakug wenin
ajatin wain ainawai.

Wisha yaitja.

Jintinkagtin uchi aimaun antawai.

Anentaimsa adaitain daajin wamak ejeti tusa,
yujag dakumjamun, uchin iwaintawai.

Dekatkau aujui anentaimsa adaitain emak
agagbauwa nuna, nagkanak, uchijai injuntsag,
yujag dakumjamun diisa, egainawai tuuki
amaineta. Nu u aina nunak, akanak ukuawe.

Nui juki, patatkau agagbaun aujui, nagkanak,
yujag dakumjamu akagka ukutbauwa nunuiya,
egawai anentaimsa adaitain, daijin.

Aikasag emawai, uchi, anentaimsa adaitain,
daajin ejeti tusa.

Jintinkagtin, tikich anentaimsa adaitain
iwainawai.

Makichik jigkai shuwin
pegkejush wajaknaitjai.

Saepchijuk chichapchi,

Etseek wakejus yujin ainawai.

Wajuk takajam tantaume, aiksamek
emata, uchi anentaimsa adaitain daijin ejeti.

Jintinkagtin, uchin papii takatain, nuwigtu
yujag dakumjamu tinamui. pag. T1.

Waji atsumnawa

Ikamia yujag dakumjamu: tauch, daum, yaas,
yugkua, kunchai, akagnum, kugkuk.

Anentaimsa adaiyat augbau antukam, dakumkamu diisam dekaskea nunu mamikjam
jukim anujata.





A large, empty rectangular area with rounded corners, outlined by a thin green border. This area is intended for students to draw or write their responses.

Daag:

Bikut ikigmaja yutan jintiauwai

Jintinkagtin ujamau

Jintinkagtin uchijai chichak tawai, uchi nuwa aishmag aidau atum uwejum bika aig mama yuwamun wainkajai duwi ipajime Bikut pachisa augmatbau antukmi tusan.

BIKUT

Makichik uchi aishmag akinaya tuwajame. Nunikmatai apaji chichak uchi waimaku, kakajam ati tajai tusa, pipichik umumainchau asamtai baikuan ujutchinum tsae tsasetas ema akujia tuwajame. Akujam kanagmatai juki tampuchijin egkes suwen jujuk jakai tusa yumi uwejen uchupig suwen takaju, uchuptau, weniuchijin yumin dakitau dutikam nuna uwas egketu tampuchijin. Duti dutikam magkau uchi shitamu wekagu. Nigki wekagama antai dukapesh kesatus amau.

Tuja duti dutikam muun wajas nagkamau waimatan, nunik chimpuinum ekentsam pujus jintinkagtau pujutan pachis, tajimat pujustinun, jega tsuwamja pujutan, iyash kuwitamtan, nuniak wakenun wemesh, shikipakmesh, shiig ikigmagjum yuwatajum tiuwai. Bikut jintiamun pachis augmatuinawai.

Jintinkagtin inimui:

- Wajukmainaita uweg bika aig mama yuwamash.

Uchijai chichaman uminawai tuke ikigmaja yutan. Jeegash wajuk ikigmauk ainawa nuna dakumkagtak iwainainawai.

Jintinkagtin wajuk uweg nijataita nuna jintiawai.

Uchi aidau ikigmamun shiig umik emainawai.

Uchi susata papi takatai pag. 21 tijigjai.

Takamujin amukag papii takatain amasti pag. 19 diisa takasbaujin.

Takastin uchi susata papii takatai pag. 211 agagti tsawantai ikigmamujin.

Tuwi takanua

Ayamtainum.

Waji atsumnawa

Yumi, japug, tsapa, agkunip.

Tijig, ajatin aidau.

Tsupija umikta dutikam niime diisam ataktu batsasta, nuniakum wajuakeakjia ikigmataita nunu augmattsata.





Daag:

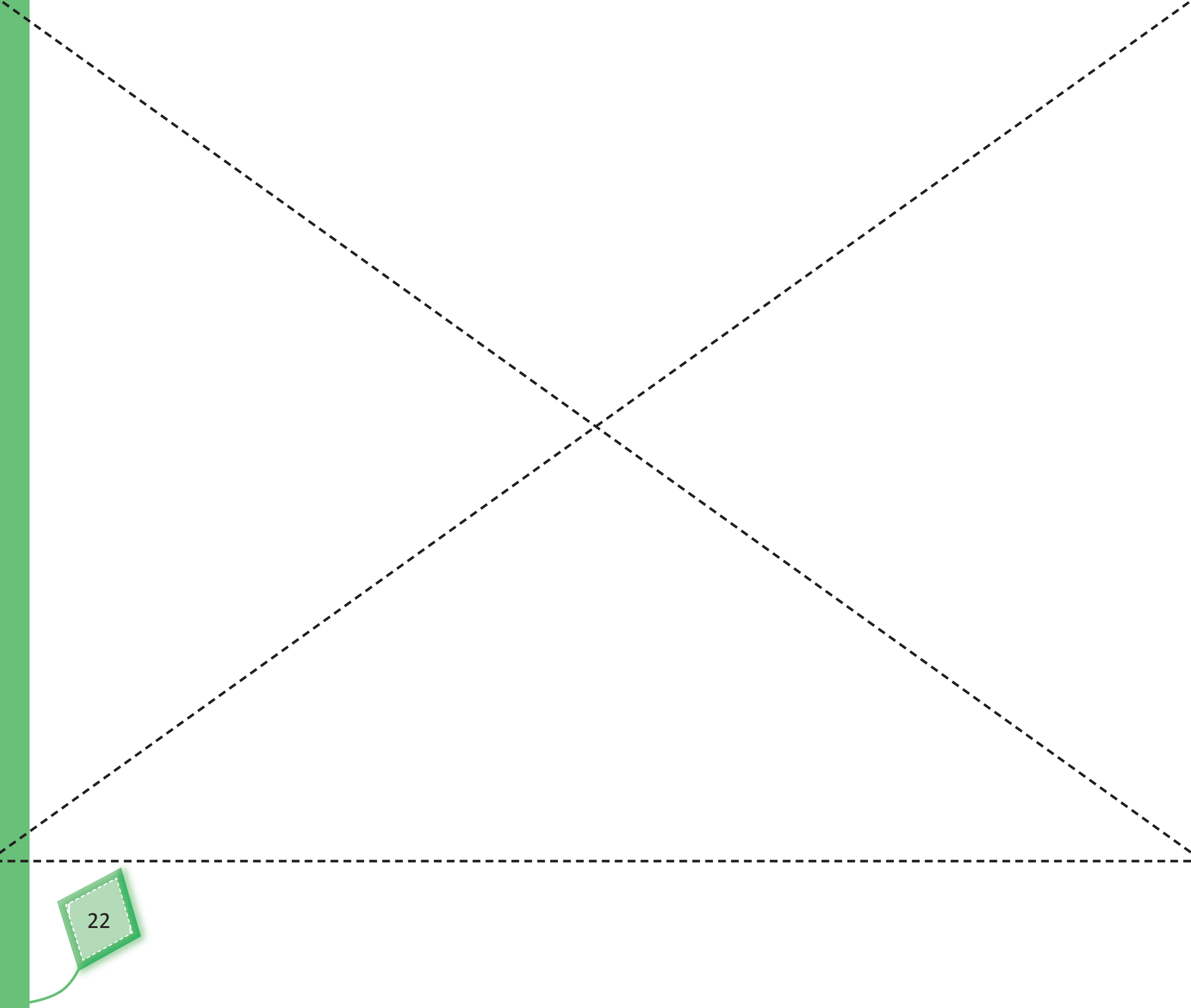

22



sukutin



papapatu



bichatin

Daag:

Ikamia yujag yuta unuimagmi

Jintinkagtin ujamau

Jintinkagtin ayamtainum kunchai nejen ejewai. Uchi kunchai néjen diisag augmatuinawai wajukuita niimish, jakitaiji, kijigji; nuninak etsejuinawai juju yujag aidaush, wajuk kuitamsa yutaita, jigkayin kajegjai tusash. Kunchai jigkaitin asamtai kuitamansa yutan chichainawai.

Jigkayin kajemjaig tusa.

- Wajukmainkita kunchaish yumi nimpainnum egkea ukukmash.
- Wajukmainkita kunchaish, yumi bichatnum egkea ukukmash.

Jintinkagtin uchi chichamun papinum agawai. Kampatum ichinkanum, yumi bichatin, papapatu, nuwigtu sukutin aidaun, yajakag batsainawai.

Nuniak shig esetus diinawai kunchaish wajukeawa nuna.

Apatuk diinawai nagkamkush wajintuk agajagmaki, nuna inagnaku dekamujijai.

Tikich yujag aidaun kunchahijai betek imintaish tuu ainawa.

Kunchain iminak kumpajijai uiwinawai, nuwigtush aneaku ainawai, wajuk kunchai yutaita.

Waji atsumnawa

Kunchai, ichinak, yumi sukutin, papapatu, yumi bichatin.

Yumi ichinkanum yajaka batsatbau diisam, tuwi etsetaita kunchaish, nunu dakumkamu jukim anujata.



Three horizontal dashed lines for writing, positioned to the right of the girl's illustration.



Daag:

Wasugkamtai najanat unuimagmi

Jintinkagtin ujamau

Jintinkagtin uchin iwaintawai, yusajjak, chií yumi, kumpia jigkaji jujukun, nuwigtu etsen, nuniak iniawai waji jujaish najanmainita tusa.

Jintinjamati tusag muunta jeen shimawai.

Nui juwak uchin papii takatain tinamui; nuniak wasugkamtai diisa najantain aujuinawai, adeag takasagtatus.

Antsak tinamui, ashi wajiwai takastata nunashkam:

Chií yumi - tsapa; yusajjak, etse, etc.

Jintinkagtin uchin wakemitkawai wasugkamtai najanat umikmaun iwaintak.

- Chií yúminum chimpiata jingai aidau (yusajjak, etse, kumpia jinkaji, etc) chimpiata.
- Chií yumi waaji, numijai sepetuata.
- Pegagkum wasugkamata.

Kumpajum 5 mijan aidaujai yapajiam wasugkamata.

Yaa yaimainawa

Muun aidau.

Tuwi takanua

Ayamtai agajin.

Waji atsumnawa

Chiwi yumi, numi, chichau jigkayi.

Wajuk najantaiyaita wasugkamtaish, nunu diisam najanata.



Three horizontal dashed lines for writing, positioned to the right of the girl's illustration.

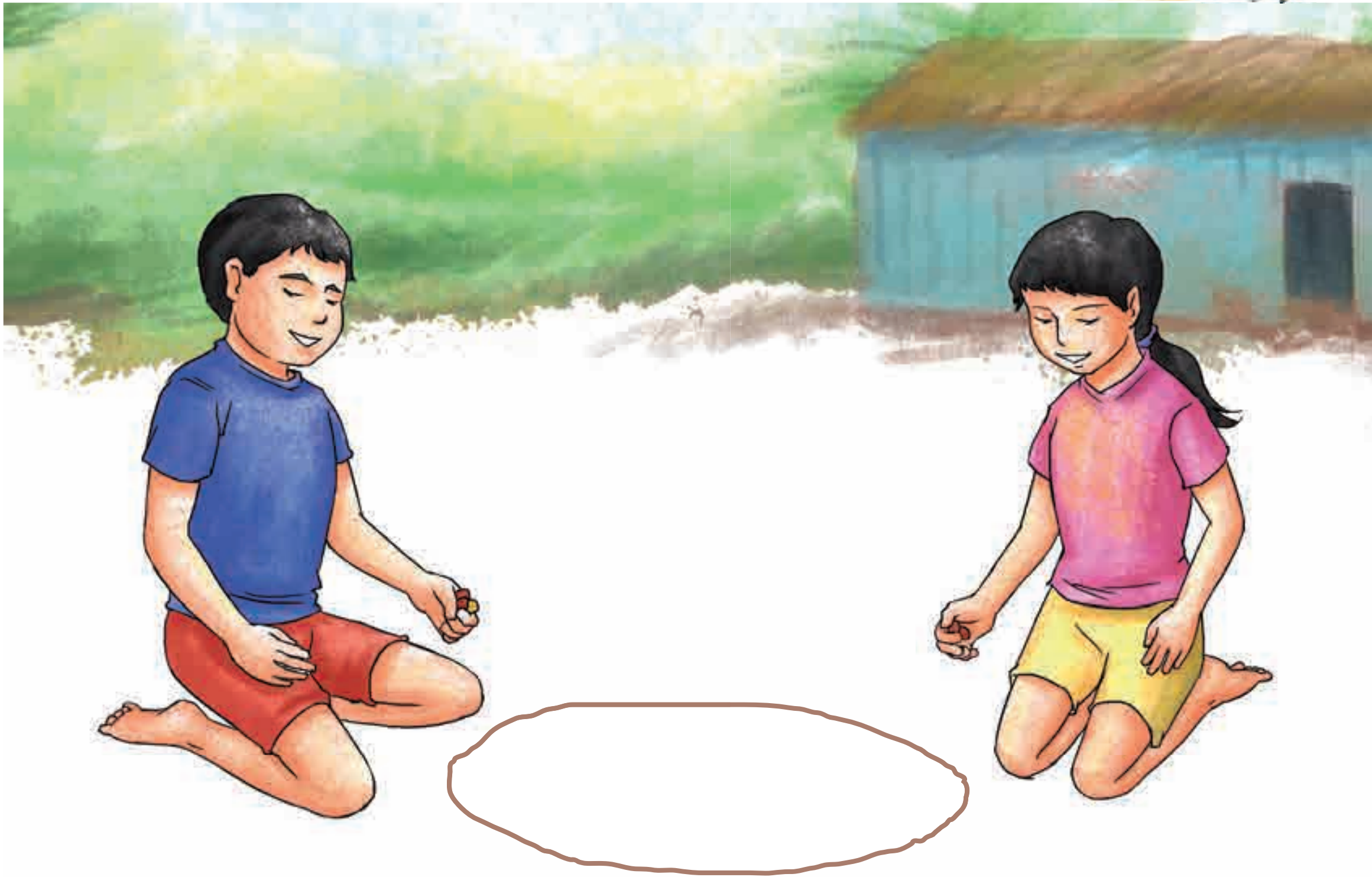

Daag:

Wasugkamami jigkai tishikiamu

Jintinkagtin ujamau

Jintinkagtin, uchin, kuashat jigkai aidaun iwaintawai, nuniak iniawai:

- Atumesh dekajumek jinkaijaish, wajuk wasugkamainita.

Uchi aidau iwainmainawe jinkaijaish wajuk wasumkamin ainawa nuna.

Jigkaijai wasugkamkujik iina kumpajjai tukuniitsuk, apatsuk, dujinum egketsuk, kuwishnumkesh egkeashtatji tusa augmatuinawai.

Augmatus nankagkamtai, jintinkagtin uchin ujawai jigkaijai, tikich wasugkamtain.

Duka wasugkamtain, jigkai waa tenteamunum egkeamui tutaiya tawai.

Uchi nuwauch, aishmag aidaujai, dekapes diisag, tishikiawag jigkain tenteamunum egkenawai.

Tuwi takanua

Ayamtai agajin.

Waji atsumnawa

Jigkai kagaju aidau (achu jinkají, etse, batae, etc)

Jigkai tishikiamush wajuk juwakme nunu dakumkam kumpajum ujakta.



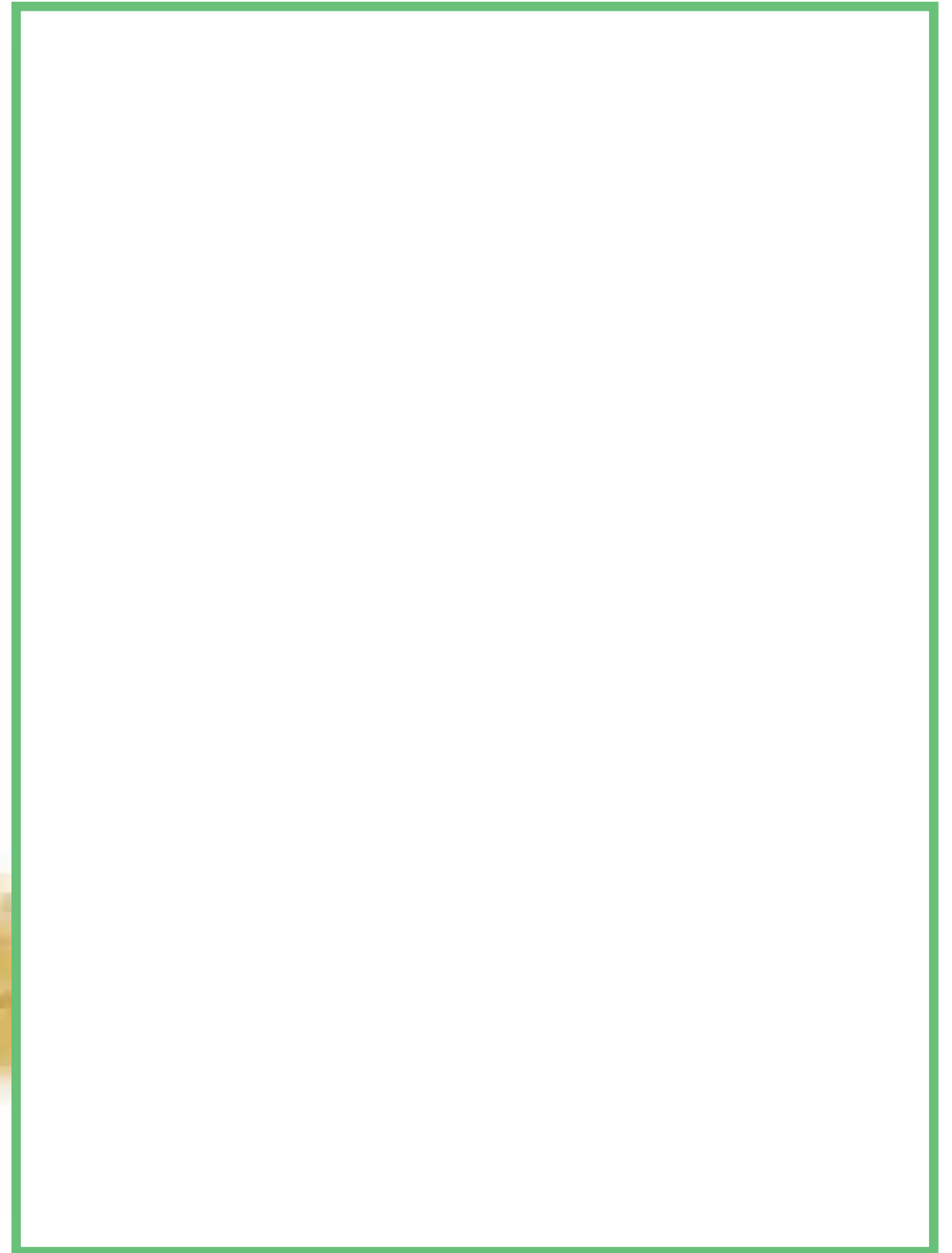

Daag:

Ikamia yujag yuchatai dekaami

Jintinkagtin ujamau

Jintinkagtin juwawai unuimatainum, kampakum yujag yuchatain aidaun. Nuniak uchin ujawai, wajuk dekauwaita yujag etegka yutash, wagki iina nugkeanig yujag yuchataish ayau asamtai.

Aniu asa, aujui bakichik augmatbaun.

Ikamia yujag yutai tuja yuchatai aidau dekaami

Wika, pipish asanuk apachjujai ikam wekaeyin ayajai. Jintaa wesa yujag ayau wainak ujatak tuyi: chimi, kunchai, inak, apai, shagkuina ainawai juka yutaya tujuti. Jujunak kuntinush tsamaka kakegun kautin ainawai tusash ujati.

Yujag yuchatai aidaunash numijin antig wegak daijin adaituk jintinjin ayi, nuniashkush neje iyajun iwaintujak tuyi: juka kaashnum, tsegasnum, kupat, yumpig, tsapatag, shishim, yugkuanim, bakaig aina juna nejeg yuchatia, yapau, tsupau aina duka

apashtaya, tuyi. Yuwajik jataiya imaka, wake inagtaya nuniaku ijagki jataya. Tujash kuntin aidauk, yuu ainawai, ditash aidau asa; tusa jintinjin ayi.

.

Apachjua nunu jintinjuau asamtai wika yujag yuchatainak yuchaujai.

Augmatbaun shiig jikatus uchi antuinawai.

Jintinkagtin iniimui:

- Tuu ainawa, yujag yutai aidaush.
- Tuu ainawa, yujag yuchatai aidaush.

Jintinkagtin uchin papii takatain tinamui.

Tuwi takanua
Ayamtai.

Dakumkata yujag, yuchatai.





Daag:

Unuimagbau iwainmamau

Jintinkagtin ujamau

Jintinkagtin uchi aidaun anentaimtikawai wajina takasagmayi.

Kumpajijai augmattsagtatui wajina takasagmayi nuna.

Yamai ame dakumkata tita wajina wakejusash takasajiawa.



Three horizontal dashed lines for writing practice, located to the right of the girl's illustration.





Juti ajajig
tinamja
ajakmauwai



Daag:

Nugkui augmatbau

Jintinkagtin ujamau

Uchi aidaun, dukug, nugkui pachis
augmatbaun antuinawai.

Dukug, uchi aidaun ujawai, ajaka ajakenak
Nugkui sujamsauwai, ajakma yuinak
batsamsatnume tusa.

Uchi aidaun ayamtainum chimpimawag
augmatuinawai Nugkui pachis.

Jintinkagtinjai batsamsag augmatus
chichainawai Nugkui ajak sukagtusbauwa
nunu juti patatish yamaish ajanuak tusag.

Jintinkagtin inimui: wajukatnuk ayi nugkuish
uchi aidaun waitkashmash.

Jintinkagtin uchi aidaun tinamui papii
akankamu takastinun nuwigtu inaktawai
dakumjamu aidaun pag. S2 nuwiyam disa
takastinme tusa.

Yaa yaimainawa

Makichik dukug muun.

Tuwi takanua

Dukug muunta jeen.

Dakumkamu diisam pataetukam augmattsata nugkuish inash waji ajakna
ukugtamkiuwaita.



Three horizontal dashed lines for writing, positioned to the right of the girl's illustration.



Daag: _____

Tsawan ajakmatai dekam

Jintinkagtin ujamau

Jintinkagtin, uchi aidaun, iwaintawai tagkáana yagkujin, nuigtu tagkana wachijin.

Uchi iniamu:

- Atumesh tankaánash, tagkanjaish wainnukujum.
- Tagkaana yagkujish, tagkana wachijish wajukuita.
- Tagkaána, tankanjaish tuke Yagkujuawash. Wagka.

Uchi aidaun, jintinkagtin ujawai: tagkaána yagkujakuig, tagkán ajak ajakmat nagkamnawai tusa.

Nuwigtush ujanui juke ainatsui tusa.

Tagkaána.

Uchi aidau augmatainawai waigkamuji pachis; nuwigtu ejetuinawai tagkaána, tankanjai, betekash aina.

Tuwi takanua

Ayamtainum Ikam wekaegas.

Tagkan: tagkan wachijukushkam diisa ajakmataiyi wachijig esagmai yagkuttakui, bukamkatui.

Dakumkata makichik ajak yagkujak ajakmatan ujajatu.



Three horizontal dashed lines for writing.

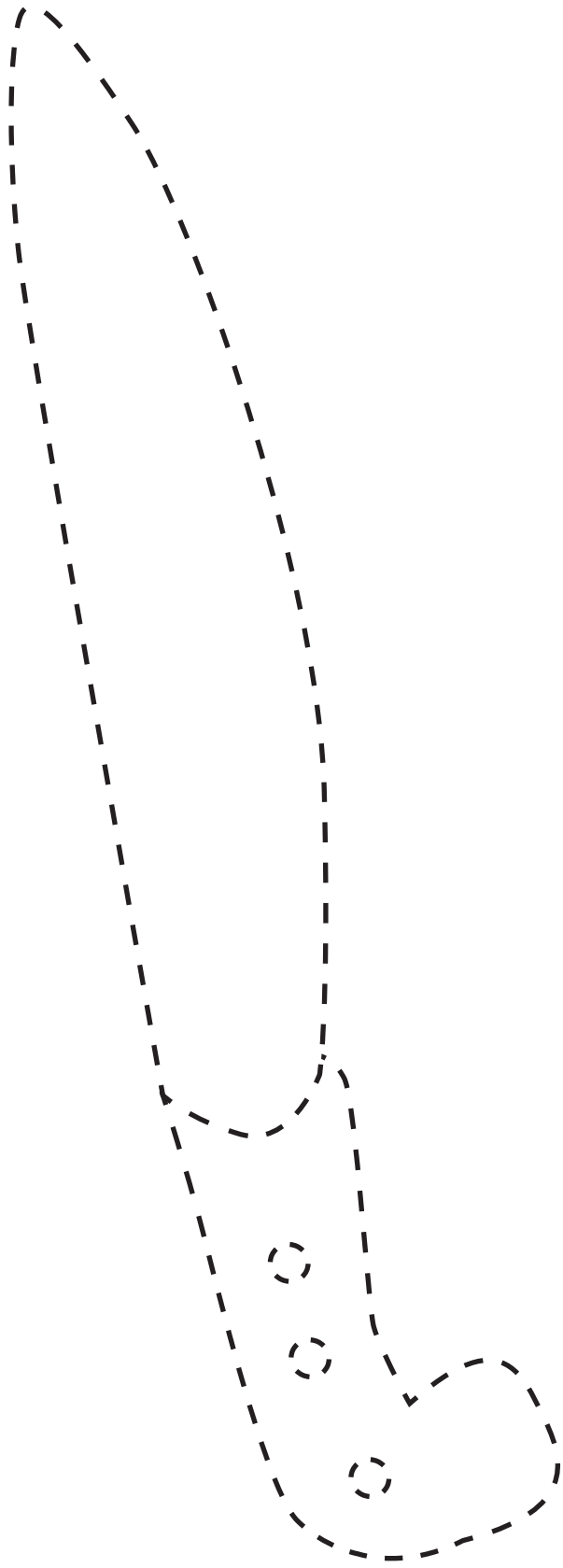
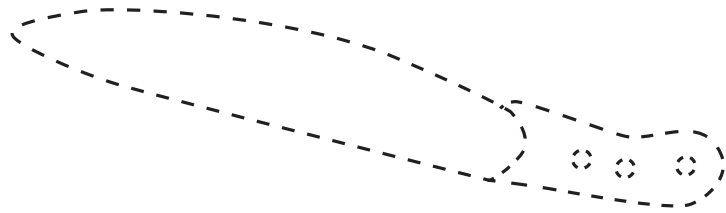
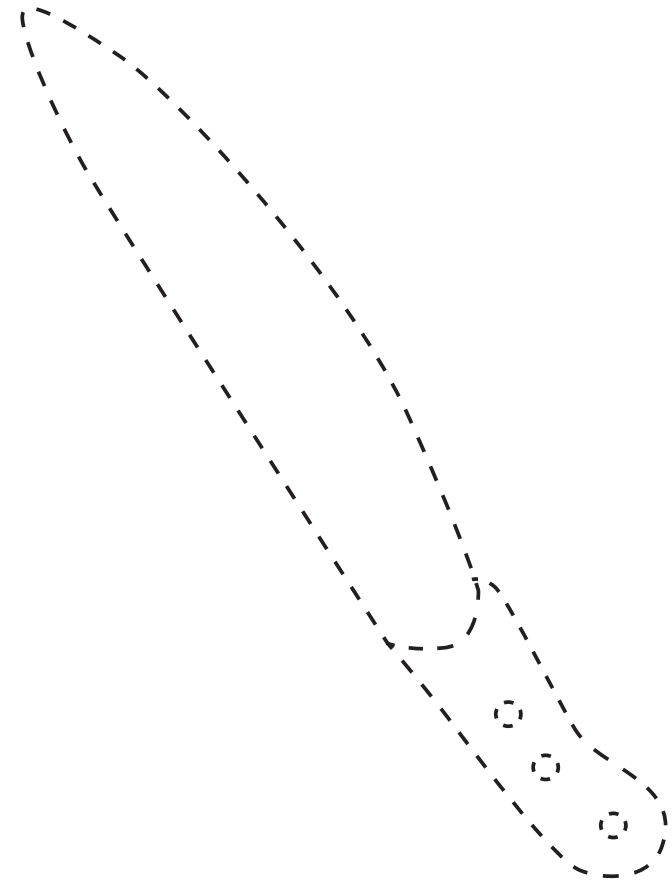

Wajiyai ajakmataiyainta nunu dekaami

Jintinkagtin ujamau

Agaa jiinag batsamas etsejuinawai,
ajakmatasash wajiyai takau ainawa.

Jintinkagtin iwaintawai wain, machitan,
palanan, chagkinan.

Uchi aidau etsejuinawai wajinma yaijatua
nuniak augmatuinawe ditash tunak takajawa.

Dakumkagtuinawai wajuk takatayaita.

Jimag juunikag wasugkamainawai, bachit
wawajai najanamun.

Jintinkagtin iniawai:

- Bachitash betekak aina.
- Apá bachitjish aminujai apatkamash,
betekait.
- Wagka betekchauweta.
- Wajuku bachitjai mamash tekagnawa.

Papii dakumkamun tinamui.

Tuwi takanua
Ayamtainum.

Waji atsumnawa
Machit wawa najanamu kumpatum ajakmaku
takatai.

Patakam tsegtsakta, tujai amesh ajanmash takamainetme. Dutikam augmatsata wagka etegkaume dusha.



Three horizontal dashed lines for writing practice, located to the right of the girl's illustration.

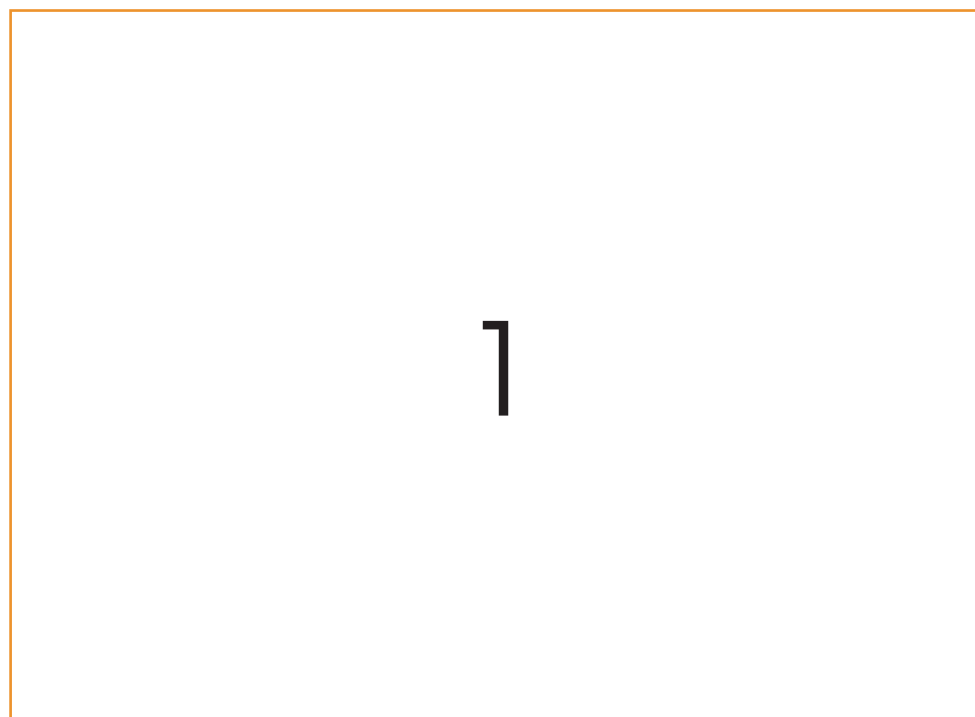

1



2



3

Ajash wajuk ajamtaiyaita

Jintinkagtin ujamau

Uchi aidau weenawai aja ajamaidaun diinak.
Kakajus ijagmainchau ataig ipawai makichik
muuntan aja ajamaun ujatkatit tusa.

Muun ujawai nuniak tawai aja ajamtag takuik
ipama takataiyai. Dekatkauk nugka eganui,
dutika beekmi ipanja apea ajatia tusa.

Ayamtainum wakitkiag etsejainawai muun
ujakbaun adeajag.

Uchi aidau etsejuinawai ditash apaji aja
ajamtaish wajinma yaimin ainawa nuna.

Ijunag batsamsag egainawai nugka mamikja
ajakmatnun.

Papii takastinjin tinamui dakumjamu pag. T2
awa nuna diisa takasti tusa.

Yaa yaimainawa
Apag.

Tuwi takanua
Ayamtai agajin.

Anujata dakumkamu nunu dutikam etsegkata ajash wajuk ajamtayaita.



Three horizontal dashed lines for writing, positioned to the right of the girl's illustration.



Daag:

Ina ajají

Jintinkagtin ujamau

Ipamata uchi apajjai aniashkush dukujai, ája ajamtina nunu takastin.

Nugka mamikjamunum ajan ajamainawai.

Jintinkagtin uchi aidaun ujawai ditash wajinma yaimkagtatua nuna.

Umutai najanamun, uchi aidau ajamainawai.

Ayamtainum wakitkiag augmatuinawai diita yaimkamujin ajaa ajabaunum.

- Iina apajish wajina takasanmi,
- Atumesh ajanmash wajukamugme.
- Iik aja takainakuish, wajukmainuk wajakmaji.

Jintinkagtin augmatui ipaama takasa pujamun.

Jintinkagtin uchi aidaun iniawai:

- Tikich ipaama takataish atsuak.

Uchi aidau etsejuinawai diita batsatkamujinish wajuk ipamawajash takauk ainawa nuna.

Tuwi takanua

Ayamtai agajin.

Waji atsumnawa

Wai numi palana.

Dakumkata amesh wajinma yaimkamume nunu aneam.



Three horizontal dashed lines for writing practice, located to the right of the girl's illustration.

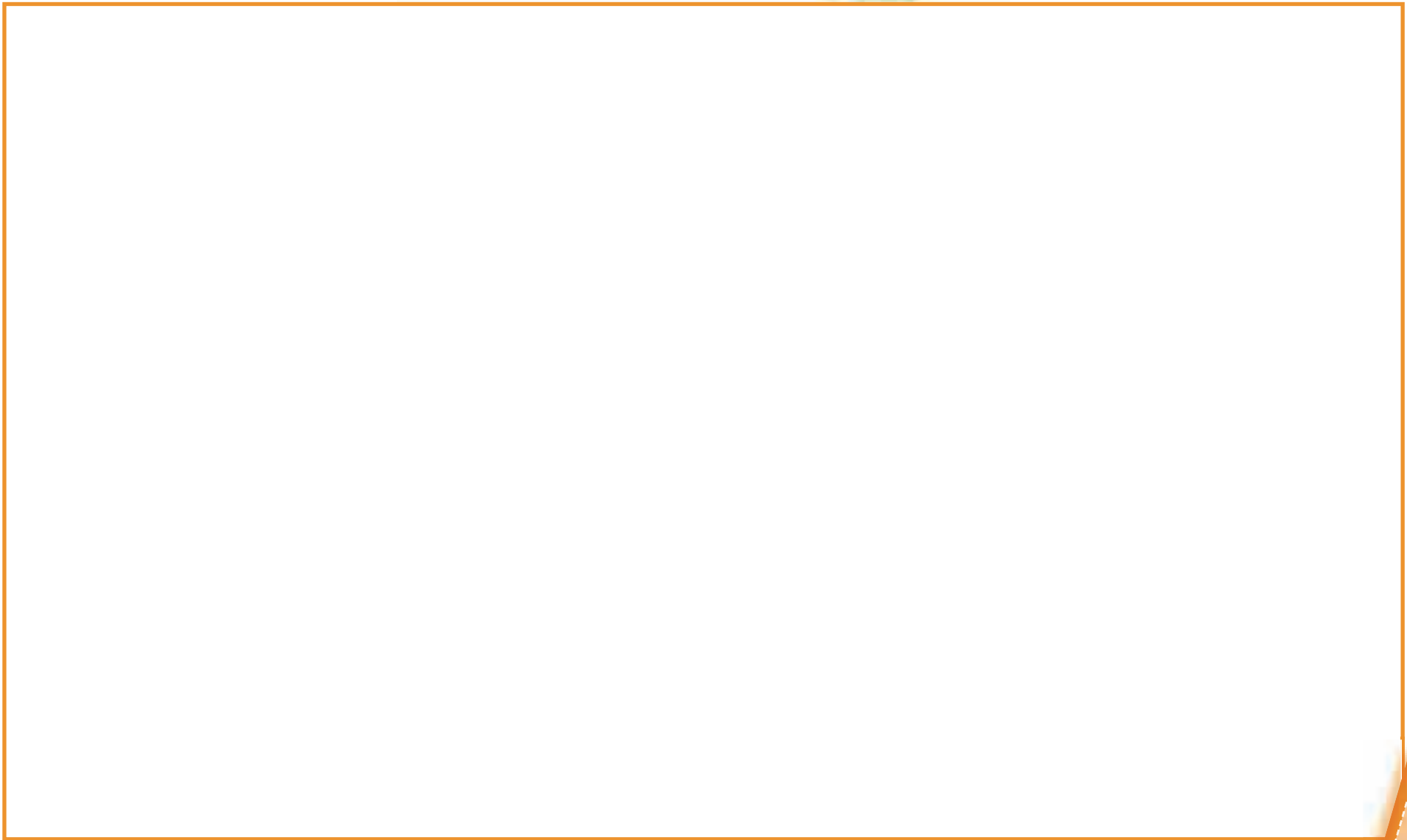

Daag:

Ajak ajakmatai ajake etejami

Jintinkagtin ujamau

Uchi aidau itainawai ajak aidaun ajanum ajatnun.

Ajak aidau daajin adayainawai.

Jintinkagtinjai anenawai muun augmattsamun, ajak pachimja ajamush wajuk kuitamainaita, nuna pachisag.

Ajak itamun diinawai betek niimtinush atsuash tusag.

Jintinkagtin ijumui uchi aidaun kam kam.

Tinamui ajak itamunmayan pegkejan, pegkegchaujai pachimag; akanjati pegkejan tusa.

Uchi aidau augmatuinawai waji ajak aidaun etejaje.

Tuwi takanua

Ayamtai agajin.

Waji atsumnawa

Ajak pegkeg aidau etejamu: shaa, duse pakagbau, tsanim, biik, kegke, idauk.

Tuu ájak etégkeamume ajáata tusamish nunu, dakumkam, daaji adaikata.



Three horizontal dashed lines for writing practice, located to the right of the girl's illustration.

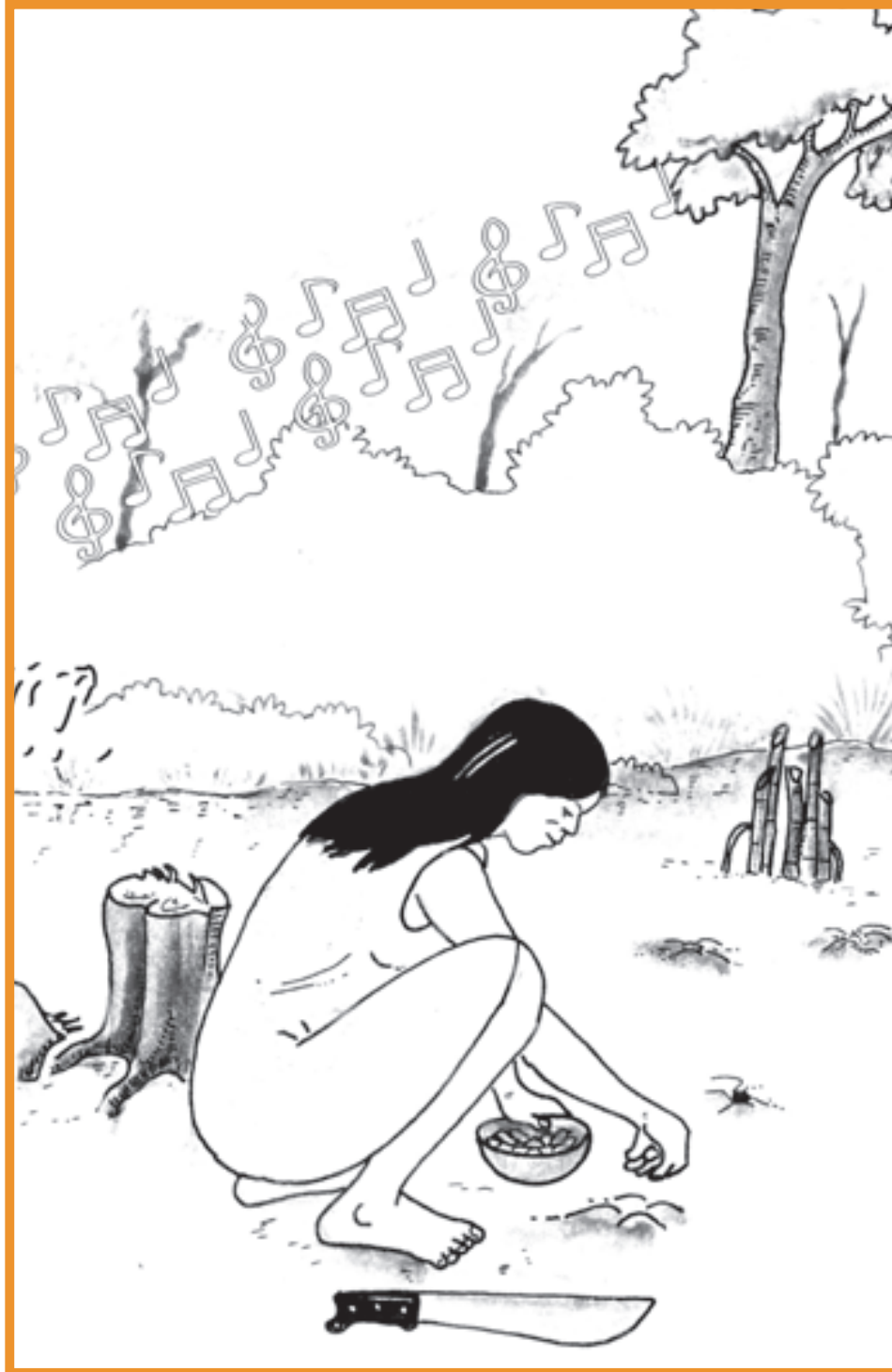

Daag:

Ajak ajamush wajuk kuwitamtayainta

Jintinkagtin ujamau

Dukug uchin ijumag ujawai ajak ajamush wajuk anenjutaita nuna.

Dukug ujawai uchi aidaun tikish pegkeg ajakma yuwatasa takatai aidaun.

Jintinkagtin ayamtainum jegaa, uchin ijumag ujawai wajimpaita Anénkash.

Nuwaush aidaun, dakumainawai diita anen antukmaujin. Aishman aidaun aitak antuinawai.

Jintinkagtin uchi audaun iniawai:

Wagka aishmagkush ajaknash anenjatsuaki.

Nagkanak etsejui tikich pegkeg ajakma yuwatasa takatai aidaun: tugkitken ajanui paampa, mejesh, piria; yumin susati tusa.

Jintinkagtin papiin tinamui.

Yaa yaimainawa

Dukug.

Tuwi takanua

Ayamtai agaji.

Waji atsumnawa

Aja.

Jakimtikata dukug ajaakan ajakmamun anegjau.



Three horizontal dashed lines for writing, positioned to the right of the girl's illustration.

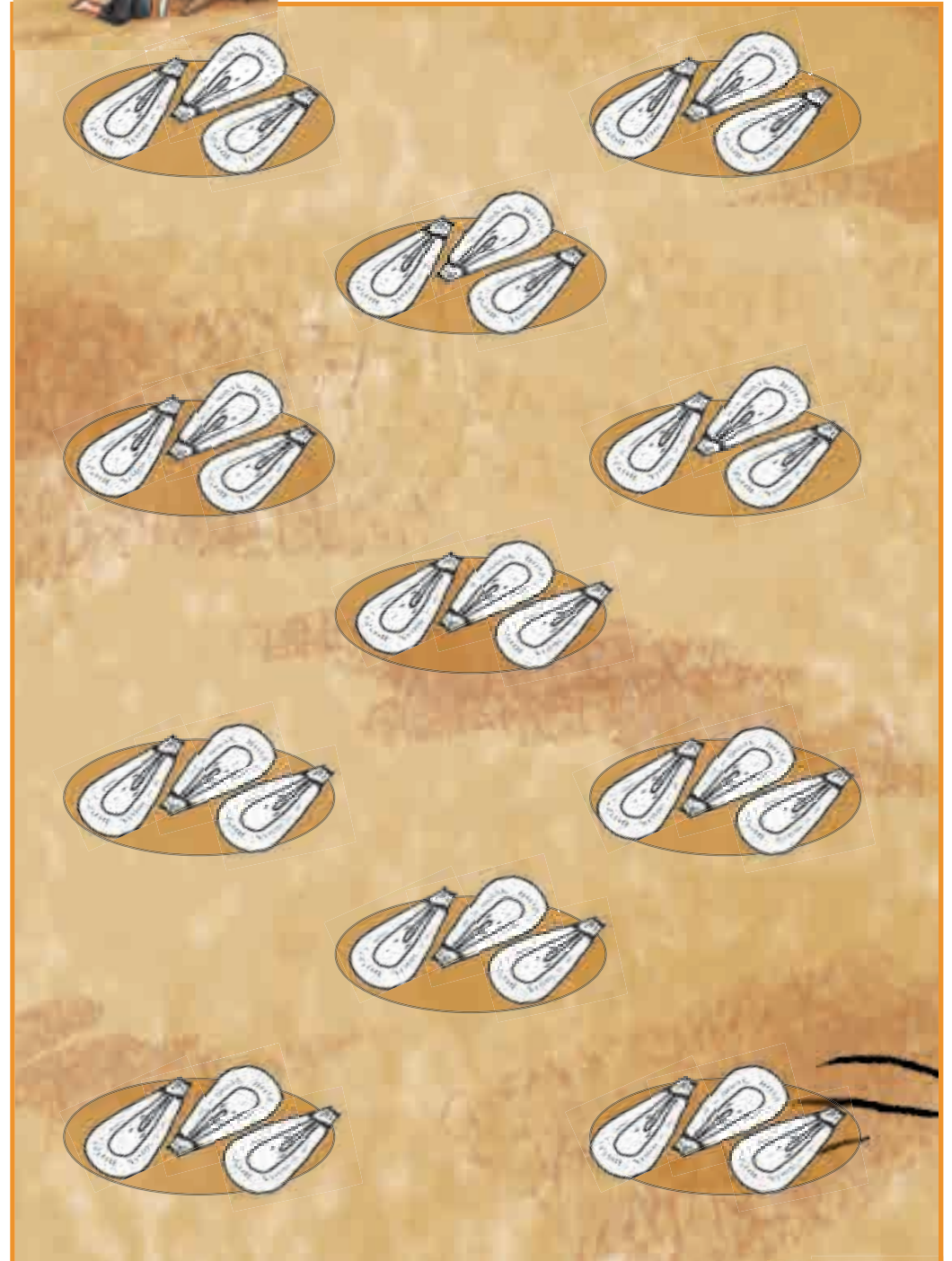
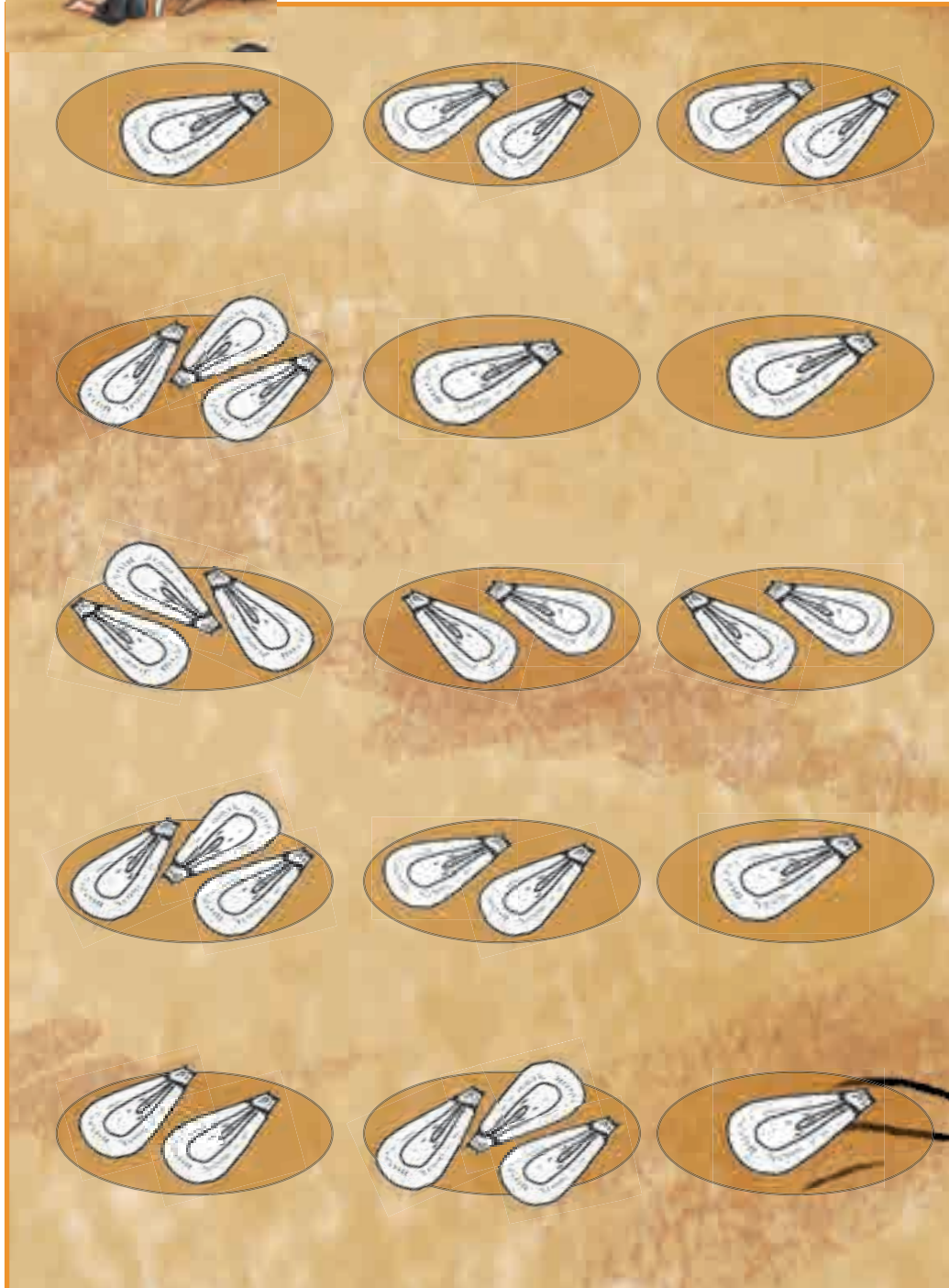

Daag:

Ajak aidaun ajake ajakmami

Jintinkagtin ujamau

Augmatui diita patayish wajuk ajakmawaki.

Nugka takasbaunum ajaka ajake etejamun ajakmainawai.

Apag, dukug, uchi aidaun uyunak wekaesan ujawai, dekatkau ajakmataiya shaa, nuniakug duse; juju tsapakui tsanim, paampa ajataiya tusa.

Ajabaunum, muun uchin saas wekaegas, waan tagawai, paampa ajatnun, agtai dukug, nuwauch aidaun, saas, ajawai dusen.

Jiintinkagtin ayamtainum wakitki, uchi aidaun iniawai:

- Ajatagtakuish dekatkaush waji dutikamji.
- Apag waa taimush apattsaik taimu agma.

- Apajush wajuk dutikame, waa taitnunash.
- Makichik waa taimunmash, wajupa ajakna ajawa.
- Wajina dutikawa ajakan ajaash.

Uchi takasbaujin iwainaktatus, dakumkagtawai wajina takasame nuna.

Yaa yaimainawa

Apag, dukugjai.

Tuwi takanua

Ajaa ajabaunum ajakmaku nuigtu iina ayamtaijin takaku.

Waji atsumnawa

Ajaka ajake etejamu aidau.

Pappiinun dakumkamu nunu ajakmamujai apatka diista; dutikam jakimtijata tuwi shiig takasmauwaita.



Three horizontal dashed lines for writing practice.

1 tsawan

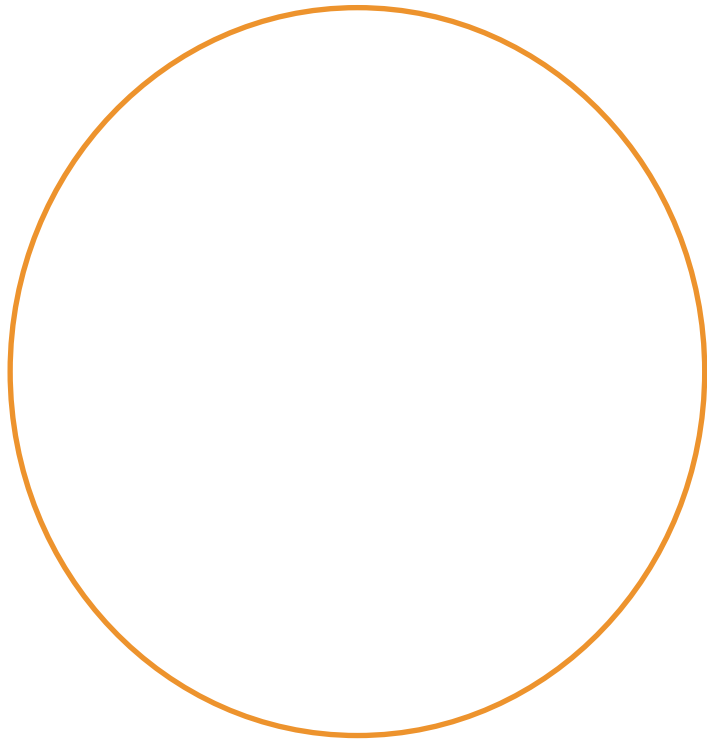

2 tsawan

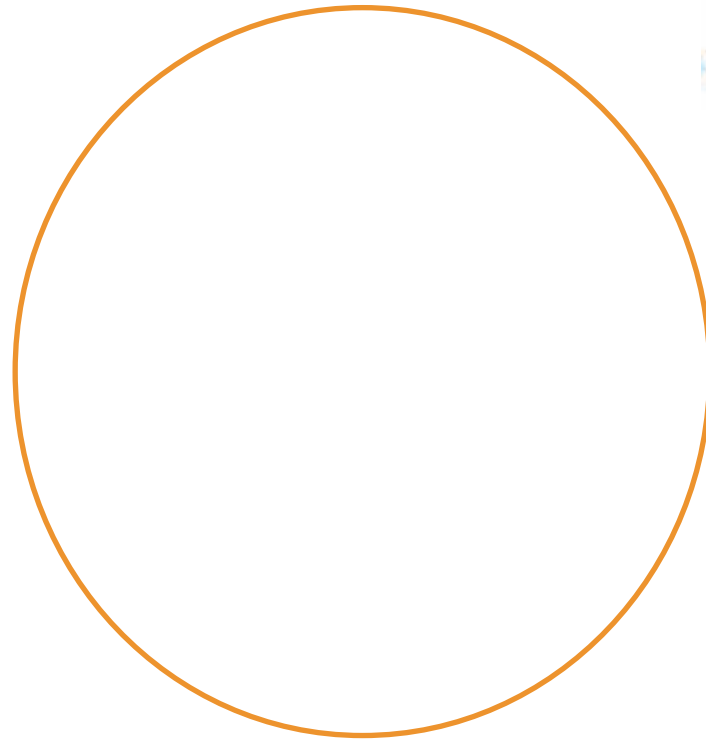

3 tsawan

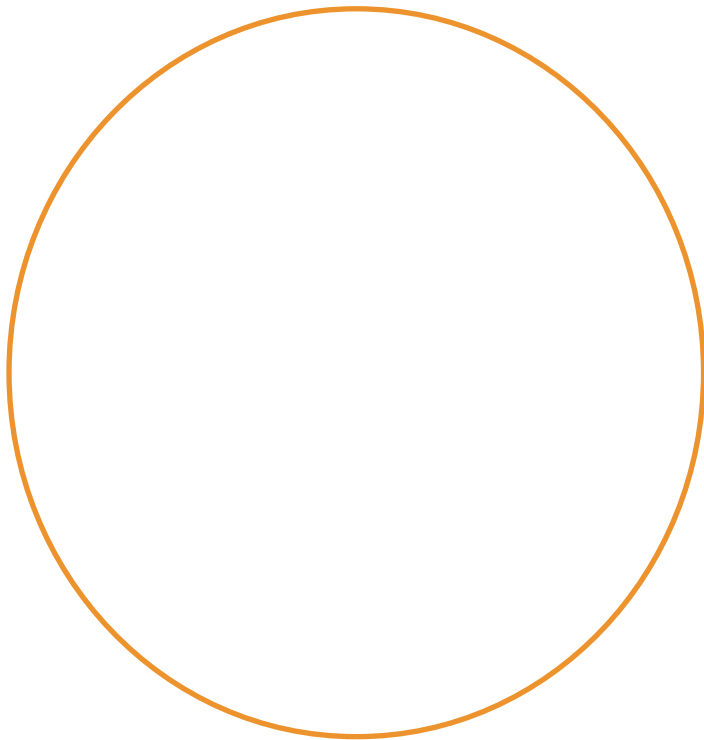

4 tsawan

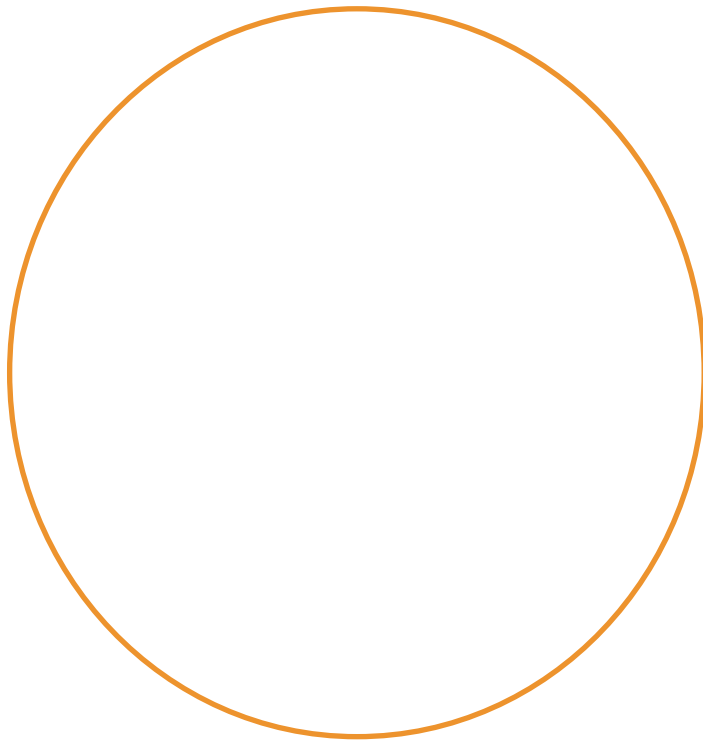

5 tsawan

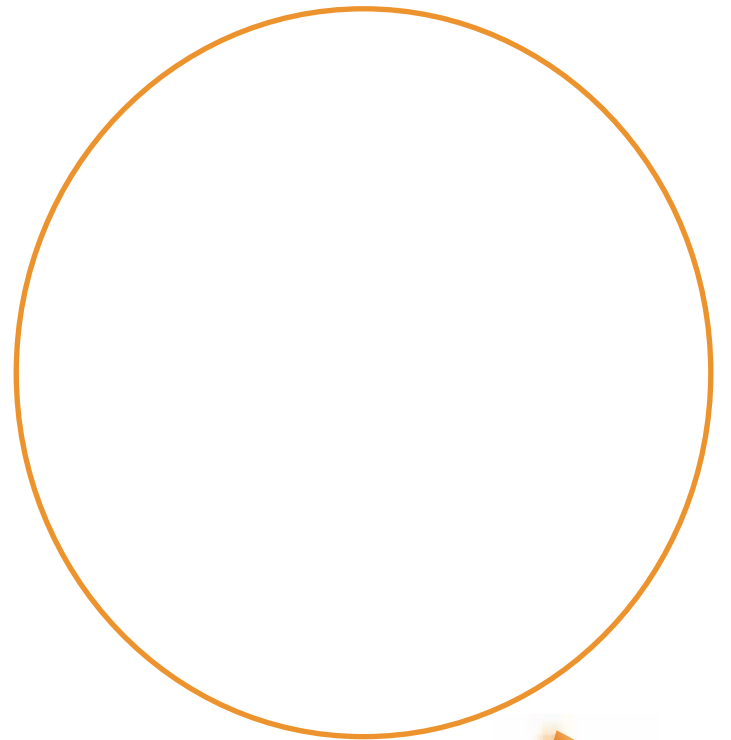

Daag:

Ajakash wajuk tsapainawa

Jintinkagtin ujamau

Jiintinkagtin ajak ajakmamun pachis iniawai:

- Waanum ajamush ajakash wajukeyawa.
- Ájak ajamush, betekak tsapaina.

Pumputnum agawai jintinkagtin uchi adaibaun.

Jintinkagtin uchin ujawai ajakash wajuk tsapawaki nunu dekami tusa.

Uchi aidaun tinamui biikan etejati tusa ajakmatnun pegkejan.

Biikan ujushjai pempeag uchupig ajawai.

Jintinkagtin uchin tinamui papiin pag. 51 numian nuna dakumainawai ajak ajakmamun diisag.

Papii takastinun tinamui.

Tuwi takanua

Ajanum, ayamtai agajin.

Waji atsumnawa

Biik, tsapa, yumi.

Ajak ajakmamush tsawan juwakush wajukeyawa nunu diisam tsentsakta.



Three horizontal dashed lines for writing.

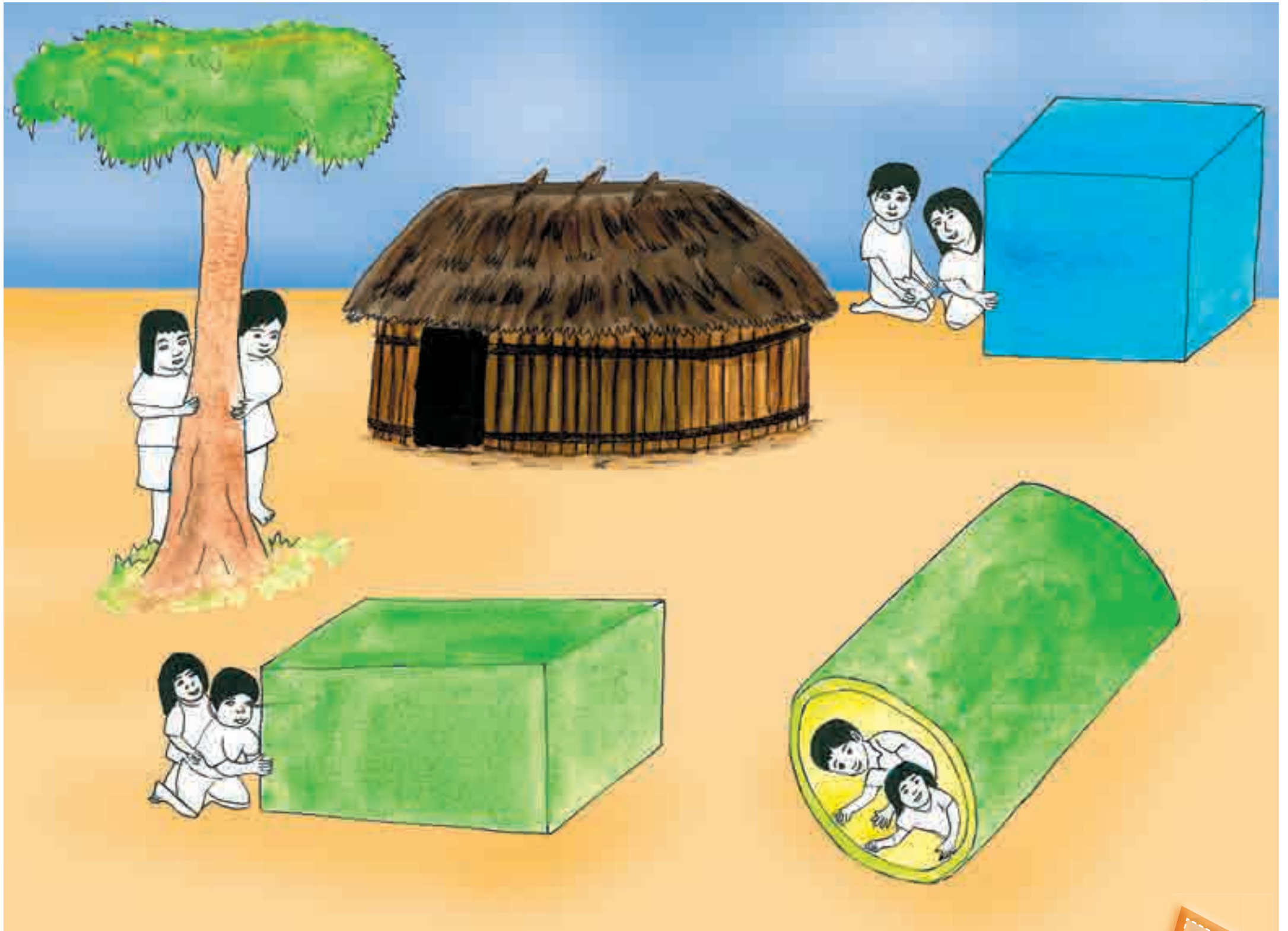

Daag:

Uumku wasugkamtai

Jintinkagtin ujamau

Jintinkagtin uchi aidaun aga jiyaawai, dutika batsatui wasugkamtai aidaun.

Etegeawai makichik uchin kumpaji umkagmatai wekaetus egaktina nuna.

Tikich aidauk umainawai.

Ayamtainum wakitkiag batsamsag uchi aidau etsejainawai tuwi umkagme, nuniak etsejainak unuimainawai "yana ukujin", yana emtin pujusaje nuna pachisag.

Tinamui papii takastinun nuniak ujawai diistajum tusa uchish tuwi pujawa nuna.

Wigkajai jakimtikata uchi nugkuaju jintinkagtinun emtin waja nunu, tuja samekbauwai jakimtijata uchi jintinkagtinun ukujin waja nunu.

Tuwi takanua
Ayamtai agajin.

Aneagta tuwi uumkamume nunu, dutikam jakimtikata amina kumpajum amejai betek umkashmaka nunu.



Three horizontal dashed lines for writing, positioned to the right of the girl's illustration.



Daag:

Unuimagbau iwainmamau

Jintinkagtin ujamau

Jintinkagtin uchi aidaun anentaimtikawai wajina takasagmayi.

Kumpajijai augmattsagtatui wajina takasagmayi nuna.

Yamai ame dakumkata tita wajina wakejusash takasajiawa.



Three horizontal dashed lines for writing practice, located to the right of the girl's illustration.





Egamka yuta
dekaami

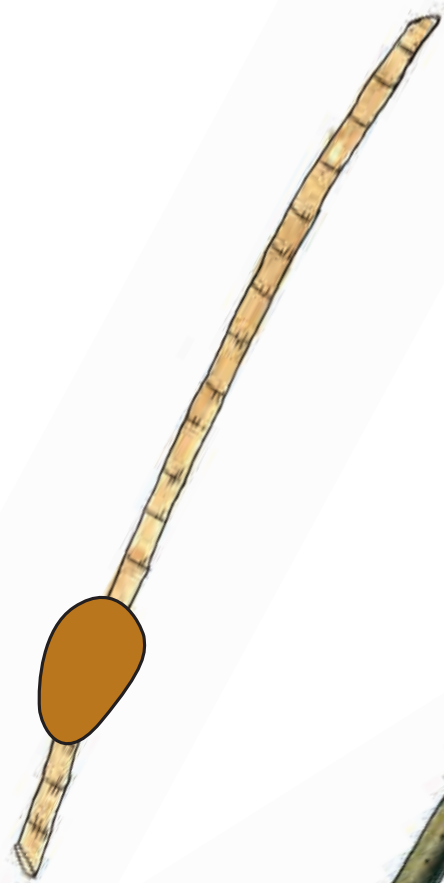

Daag:

Etsa Ajaimjai augmatbau antukmi

Jintinkagtin ujamau

Jintinkagtin uchi aidaujui apachji jeen shimawai, Etsa Ajaimjai augmatbaun, antuinak.

Ayamtainum kaunawan augmatbau antukmaujin adeajag augmatuinawai.

Jintinkagtin uchi aidaun iniawai:

- Apachish waji augmatbaun ujakpakme.
- Ajaimnash Etsash wajina segauwaita.
- Etsash nagkushpijaish wajinak mauyi.
- Ajaimnash Etsash wajina tikichnash segauwaita.
- Etsash uumjaish wajinak mauyi.

- Iinia aidaush wajinak takau ainawa Etsajai betek kuntinun main atasash.

Jintinkagtin uchin papii takatain pag. T2 kenujai tinamui.

Yaa yaimainawa

Apach.

Tuwi takanua

Apachji jeen.

Etsash wajinaa mauwaita nagkushpijaish nuwigtu uumjaish. Dakumjamu diisa anujata.



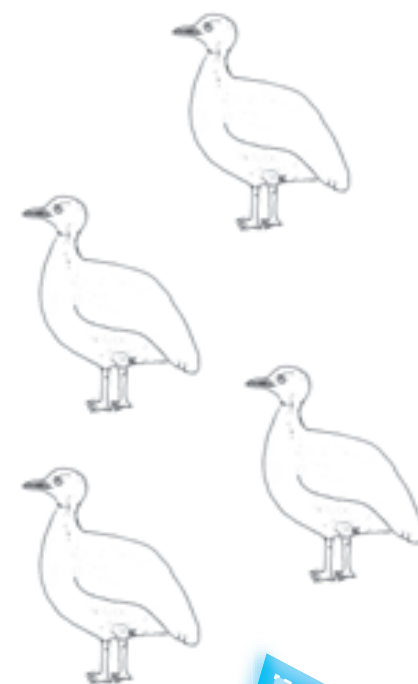

Daag:

Yaki ima kuashtash mauyi kuntinnash

Jintinkagtin ujamau

Jintinkagtin, uchijai, awaksag augmatuinawai Etsash dekatkaush wajiyaik uwettsukesh mautnash unuimajuakita.

Jutík wasugkamku, mamikjá tukut unuimagmi, tusa chichaman umikaje. Papinum kuntin dakumja numiuchinum anujamun ayamtai agajin ajinawai, aents nagkaemashtainum.

Numiuchik takatkataik ajigta antiamak waamak iyaumain.

Chichaman uminawai ashi shiig aneasa maanitsuk wasugkamatnun.

Aishmag aidauk úumjai dekapsagtatui nuniai nuwa aidauk tewa yaigjai kuntin dakumjamun tuku ajuawagtatui.

Numiuchinum anujainawai.

Papinum kuntin dakumjamun wasugkamku akakekmaun yajuak ukuinawai. Nunik dekas chicham juni wasugkamami tusa umikmaush betekash uminka nuna diinawai.

Kuntin maamujin ijumainawai nuniak pishak kuntin aidaujai akanag batsawai.

Jintinkagtin uchin iniawai:

- Wajupa maugme ashi ijumjamunmash.

Atak ijumag wasugkamainawai nuniak apatuk diinawai tukita kuntin ima kuwashtash nuniashkush ujumkesh.

Waji atsumnawa

Aishmagkuk maki makichik shashapin takakainawai, nuwauchik maki makichik tewa takakainawai.

Uchi papinum kuntin chigkijai dakumja tsupigmau.

Etsa Ajaimjai kuntin kajegmau diista nuniakum jakimtijata ujumak maamu.



Three horizontal dashed lines for writing.

Kuntinush tuwi batsatua



Daag:

Kuntinush tuwig batsatua

Jintinkagtin ujamau

Jintinkagtin, uchi aidaun, kuntin dakumkamun iwaintawai (kashai, bachig, kawau, paki)

Uchi augmatuinawai iwaintamua nuna pachis.

Jintinkagtin uchin iniawai:

- Jusha kuntin, pishak aidaush tuwig batsatua.
- Yaki ayujua.
- Wajinak yuwawa.

Uchi aimau jintinkagtin agawai.

Uchi aidau aentsun mamikinawai tuwig kuntinush batsatua, wajinak yuwaita nunu iniimsatnun.

Papii takatain pag. 63 atatman juwinawai aimau tsegtsaktinum.

Antsak iniinawai: Wajinak yuuk ainawa, juju kuntin aidaush tuwi batsatua.

Ayamtainum waketug kaunawag aimau agaja jukimun kumpaji aidaujai ujaninawai.

Yaa muunnak kuntinun pachisash iniasagme nuna kumpag. ujainawai.

Dekatkau agaja ukukmaun apatuk diinawai iniimas dekamujjai.

Yaa yaimainawa

Muun aidau uchi inimaun aimainawai.

Tuwi takanua

Ayamtainum muunta jeenishkam.

Tuwi kuntin aidaush kajinaita nunu sapagkeata.





Daag:

Wajiyai kuintinush mautaiyainta nunu dekaami

Jintinkagtin ujamau

Jintinkagtin uchijai muunta jeen weenawai wajuk kuintinush mautaiyainta nuna dekasag.

Muun uchi aidaun ujawai yajag ema chigki mautan nuwigtu chinamujaish waji kuintinua mautaiyainta nuna.

Muun uchin chichajak yajag emakjik shimpankaig tusa etsegtsuk wetaiya tawai.

Ayamtainum kaunawag muun kuintin dakamtika mautain adaijamun adeajag adayainawai nuwigtush waji kuintinuk nujaish mautaiyainta.

Jintinkagtin papii muun wegkagmanum kuintin dakamtika mautai dakumjamun iwainawai.

Uchi aidaun iniawai dakamtika kuintin mautai aidaush tukita, jintinkagtin uchi adaimaun papinum agawai, aantsag adaichamunash nigki agag emawai.

Uchi tentea iwainawai chigki yajagjai mautain. Apa wajina dakamtikau wainnume nunu augmattsata.

Waji chigkia mautaita yajag emajish nuna adayainawai.

Chigki aidaun dakumkagtus wasugkamak iwainawai.

Jim uchi kuintinun main atatui.

Maki makichik takaku agtatui kuintin dakamtika mautai papinum dakumkamun.

Uchi aidau uwejin achik juki tikich yantamnum apusattawai chigkin maajai tusa.

Ataktu jim uchi kuintinu main tusa jiikiag dutiksag wasugkamainawai.

Yaa yaimainawa

Muun.

Tuwi takanua

Muunta jeen.

Waji atsumnawa

Papii wegkagmanum dakamtika kuintin mautai aidau dakumjamu.

Tsegtsakam achimtikata dakamtika chigki mautaijai achinak juwamainjai.



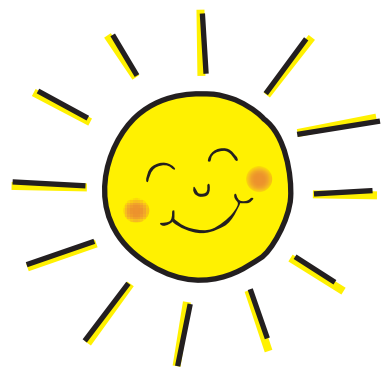

Tsawai



Kashi

Daag:

Waji aikaji tsawaish nuwigtush kashish

Jintinkagtin ujamau

Jintinkagtin uchijai weenawai muunta jeen.

Uchi aidaun, muun etsegmaun antuinawai, waji kuntin tsawaish anuiashkush kashish yujaush ainawa.

Papii augtaijin kaunawag unuimanmaujin augmatuinawai.

Jintinkagtin, uchi aidaun; kuntin kashi anuiashkuch tsawai, yujagken yuwinak, yumi umuinak, yujau aidaun, dakumja tsupigmaun, iwaintawai.

Jintinkagtin iniimui: Atumesh tsawaish waji takaugme, kashish waji takaugme.

Uchi aidau apajijai tsawaish kashish wajinak takau ainawa nuna augmatuinawai.

Uchi aidau, tsawaish kashish wajinak takau ainawa nuna augmatuinawai.

Jintinkagtin, uchi aidaun ujawai, wajimma pegkejaita, shiig ayamtash. Agtsak, chichainawe tsawai takat aidauk eme anentsa diimaine, nuniaku yaimainai iina pataji takamunum.

Jintinkagtin uchin papii takatain tinamui nuwigtu papinum dakumjamu aidaun S3 nuwiyashkam.

Yaa yaimainawa

Muun.

Tuwi takanua

Muunta jeen, ayamtainum.

Waji atsumnawa

Kuntinu wakani tsawai kashi yujau aidau dakumjamu.

Ujajam anujata tsawaish waji takaume.



Three horizontal dashed lines for writing practice.

Jempe kuntin maamu



Makichik muun uchiji Jempe daagtinum apujus pujuya tuwajame. Pegkeg pujut aidaun jintintak, nuwigtush jintintu kuntin aidau maa yutan. Dekatkauk jintintuaya tuwajame uumjai tuku kuntin mautan, tsakaja wetai jintintuau yajag ema chigki nugka yujau mautan nuwi pujus unuimajui akajujai mautan.



Jempe unuimajui kuntin mautan, kajimatkiuwai apaji kuntin imatika maushtaiya timaunak, nuniak wakejukui aan kuwashat maatatus. Nuniau asa kuntinun tsawantai kajeu, ima imatikam jegaya tuwajame kuntin amuegat.



*Nunik pujus anentaimak tiu "pegkejai kuntin maamuk
tujash kashi kashinig maa yumaitsui kuntin amuekai tau asa
nuwigtush akajujaig maumaitsui kuntin atushat shimawai".*

Daag:



*Yamaik ikam wekaeku wegamash wainnatsui bachig,
yugkipak, pabau, chigki weantuk. Juju kuntin aidauk
amuekaje, Kuwitamkami kuntin aidau tusa Jempe
indaisauwai kutin mautan, nuniak nagkamauwai atash, patu
tagkuma yutan.*



1. Wajjaig Jempesh kuntinnash mauk ayi.

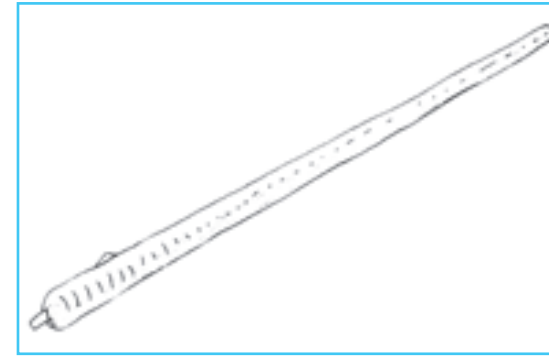
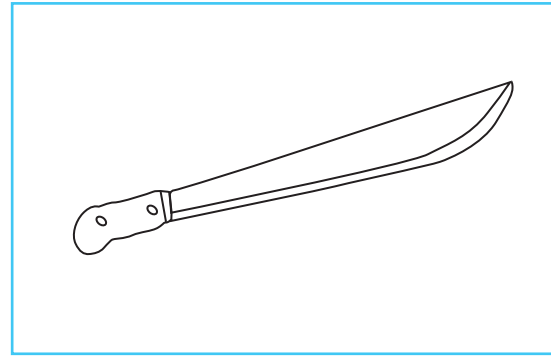
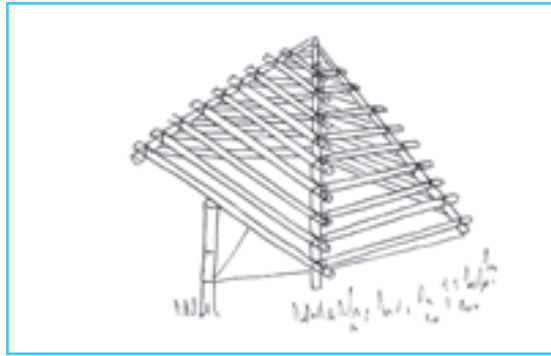

2. Jempesh, waji kuntin aidauna tagkumua, nunu dakumjata.

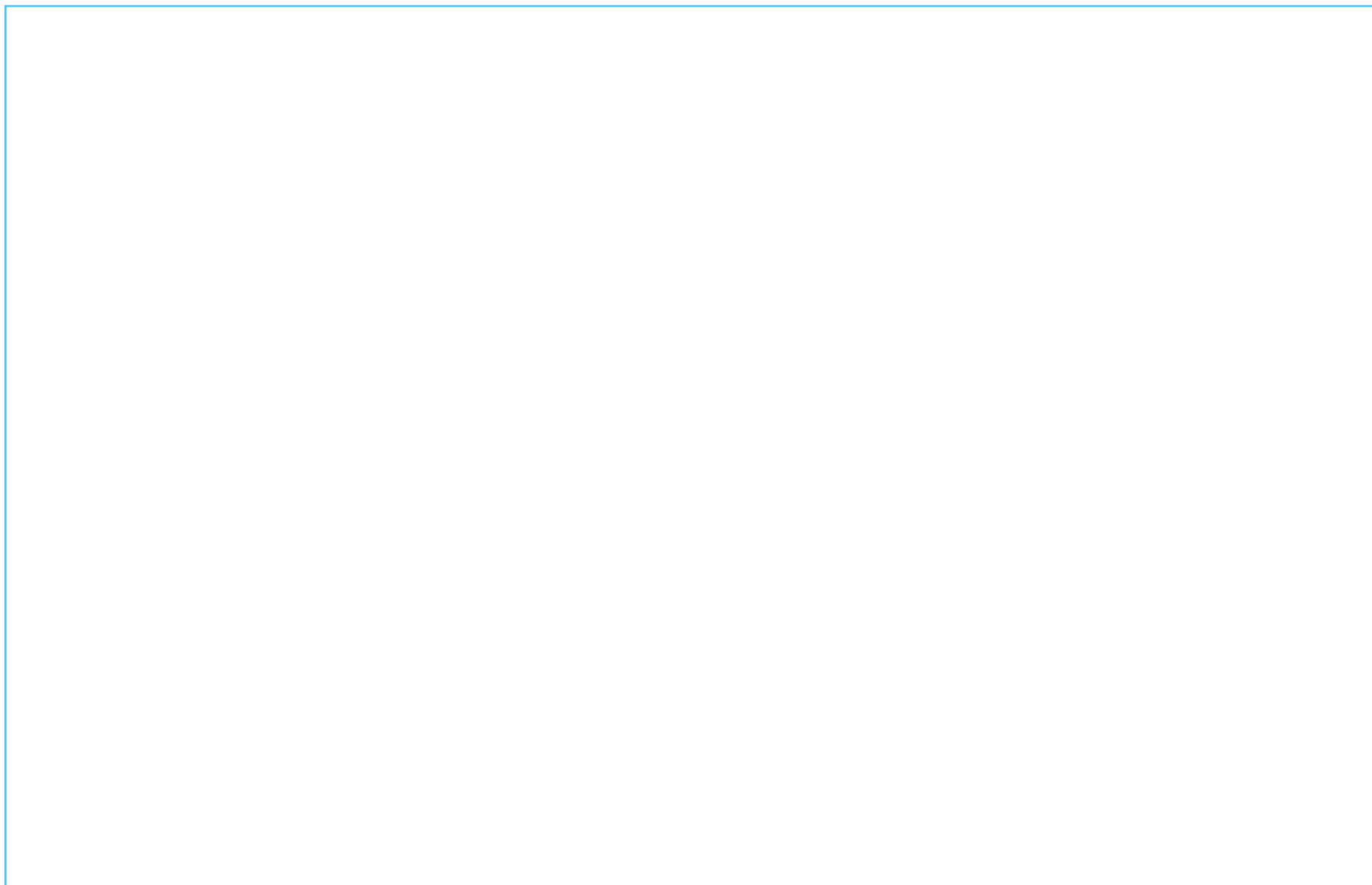

Daag:

Kuntin megkaegag wegamu augmatbau antukmi

Jintinkagtin ujamau

Jintinkagtin uchin papii takatain pag. 69- 71 tinamui.

Jintinkagtin uchijai augmatbaun aujui.

Uchi segamiagtai patak aujui.

Jintinkagtin uchin iniawai:

- Kuntin abukamtaish iiniatish wajuk pujumainkita.

Jintinkagtin uchin papii takatain pag. 73 tinamui.

Tuwi takanua

Ayamtai

Waji atsumnawa

Kuntin yamai amuegak mina nunu aidau dakumjamu.

Jintinkagtin augmatbau antukam, jakimtijata dekaskea nunu.



Three horizontal dashed lines for writing.

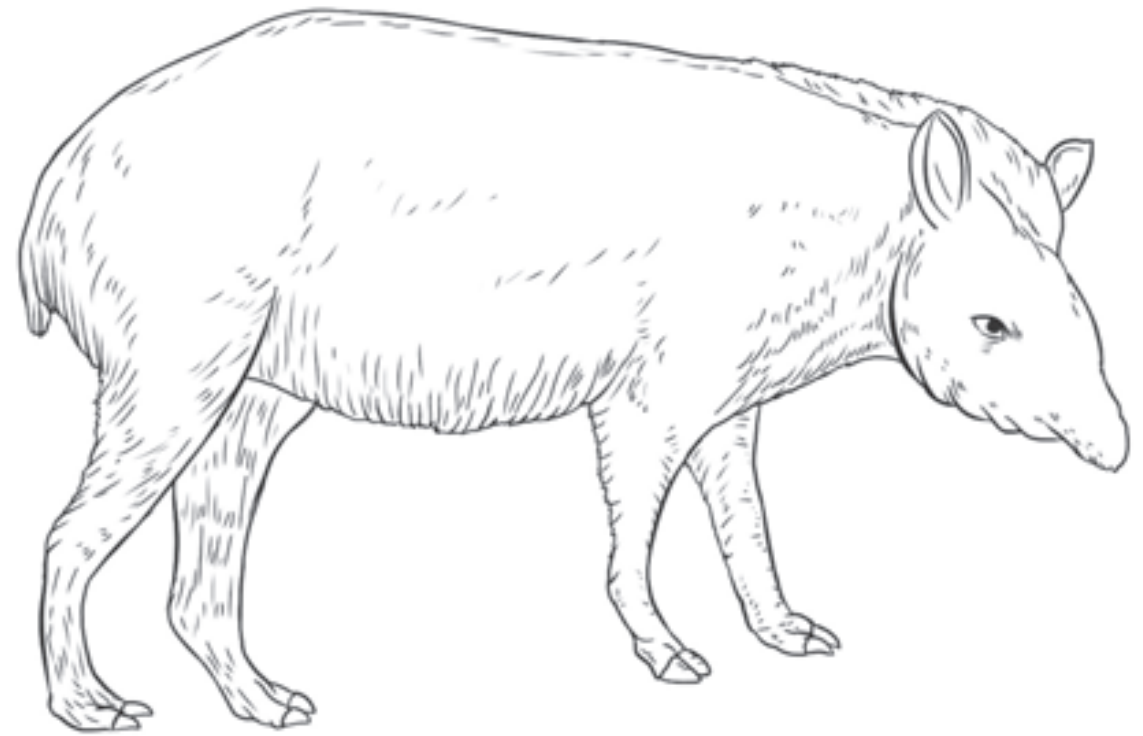
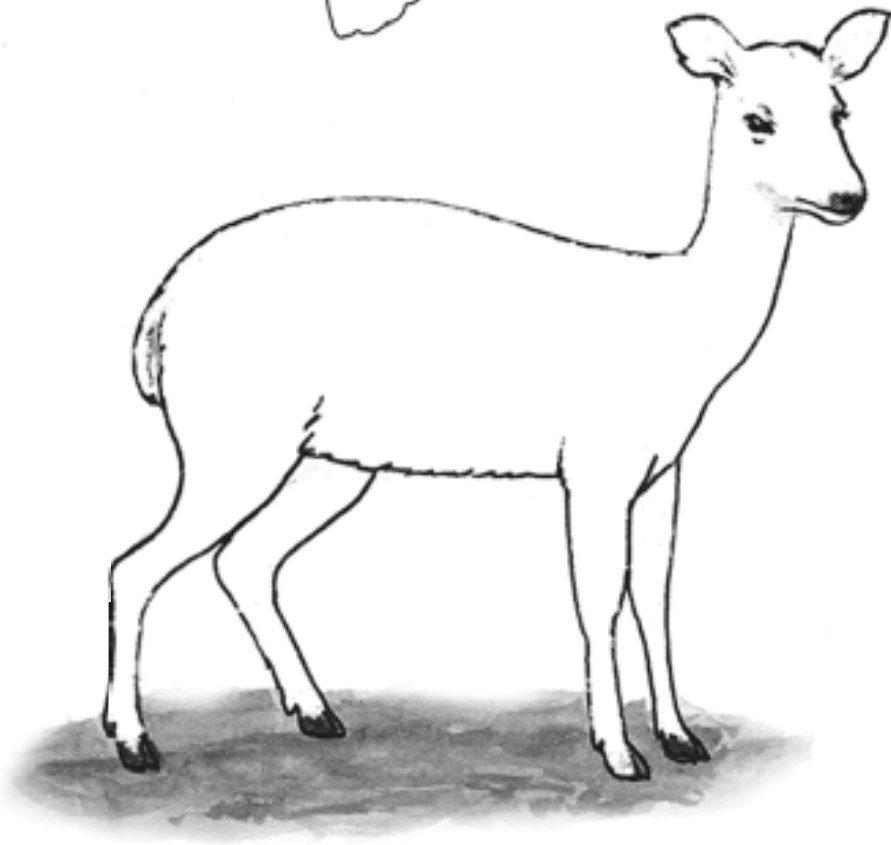

Daag:

Papi muunnum kuntin kajegchami tusa najankami

Jintinkagtin ujamau

Jintinkagtin uchijai Jempe augmattsamun patasan augmatuinawai.

Jintinkagtin kuntin dakumjamu ikam wekaekujish kakajus wainchatain iwainawai.

Uchi kuntu daajin adayak augmatuimawai tuwig wainkaush ainawa aniashkush yaa augmatmaunak antukajuita.

Wajukmainkita ikamia kuntin egamka maa yuu pujamash nuna pachis augmatuinawai.

Yaunchuk muutash wajuk ikam kuntin aidaunash kuwitama wajakuita, nuwiglush dukuji kajegtukai tusash wajuknuk ajami nuna augmatuinawai.

Jempesh wajina takakug atsumkas yumainjish ajawa ikam kuntinun egak yuwatsu duwish nuna pachis augmatuinawai.

Jintinkagtin iniimui:

- Batsatkamunmaya aidaush dekainawak kuntin amuegak minidaunash.
- Wajukeakjia batsatkamunmayash kuntin amuegak minina dusha ujamainita.

- Waji tumainkita.

Batsatkamu afiche dakumjamu ayaun jintinkagtin iwainawai. Nuwigtu batsatkamunum jinjash diimainai.

Afiche dakumjamun wainkaje nuwigtu ujumak chicham agaja jakimtijamunashkam.

Uminainawai afiche takasa iwainaktinun.

Jintinkagtin uchin papii takatain 75 tinamui.

Sup uchi juunikag etegkenawai jim kuntin dakumkamun afichenum anujatnun.

Jintinkagtin yainkam etejaje afiche agagtinun.

Umikmaun papii muun wegkagmanun batsainawai dutika diita tuwi anujata tuwinawa nuwi ukuinawai.

Tuwi takanua

Ayamtai.

Waji atsumnawa

Kuntin amuegak wedau dakumjamu.

Tuu kuntin amuegak wegawa nunu jakimtijata. Anujata afiche najanamaujum.



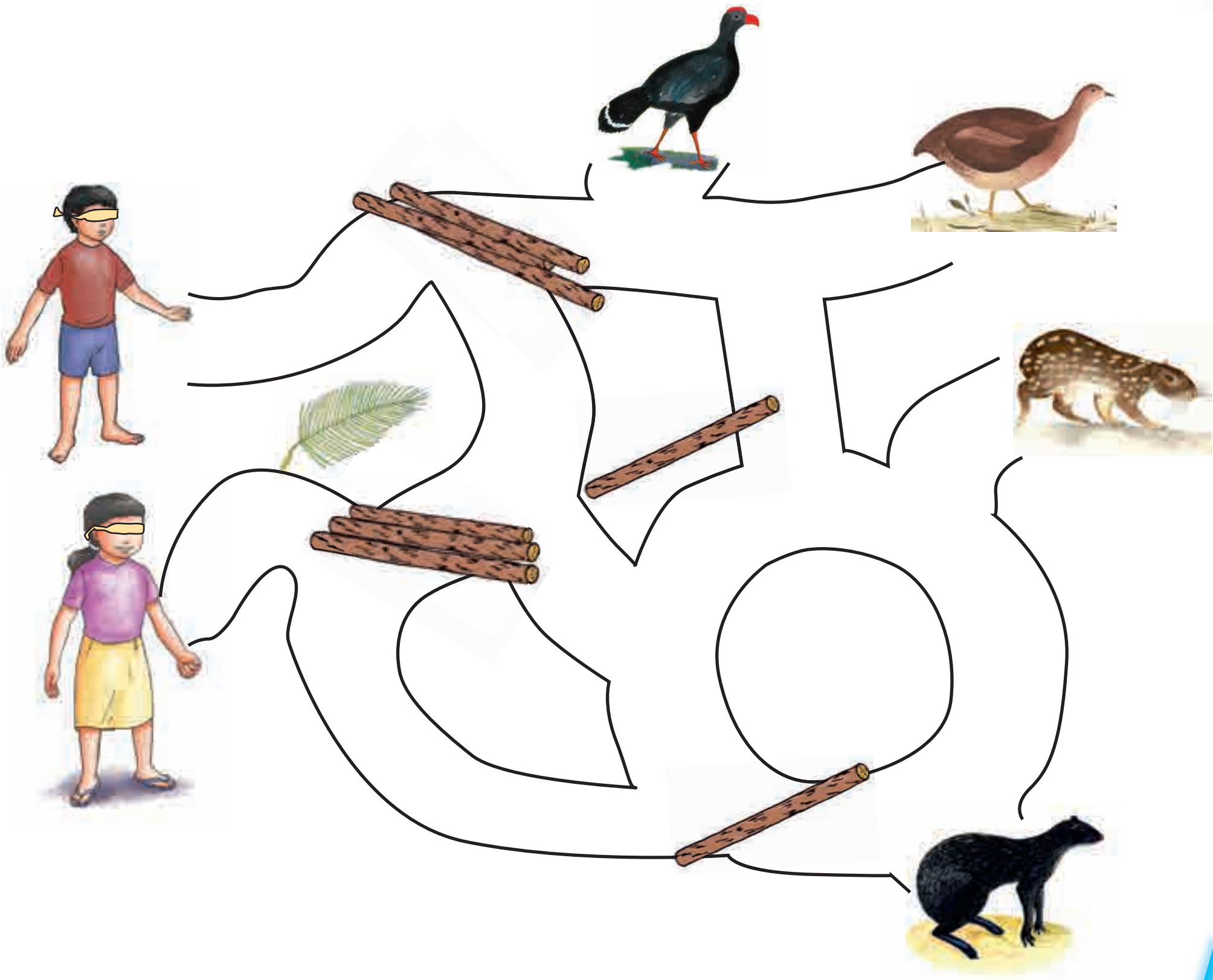

Daag:

Jintaá ainjá kuntin ejemau wasugkamami

Jintinkagtin ujamau

Jintinkagtin wajuk wasugkamawagtatua nuna uchin ujawai, nuniak tawai: amain kuntin shiig kuwashat ayau tuinawai, Dusha, wajuk katigkaiya kuntinush jumainaitji.

Jintinkagtin batsawai kayan, duka, numi aidaun katigtakama utujimkati tusa.

Jii epeka wasugkamainawai kuntin batsatmaunum jegatatus.

Kumpaji aidaun eem weta, ukunum wakitkita aatus ujainawai.

Wasugkama nagkanainak augmatuinawai jii epeka wasugkamaunash shiig aneasajash wasugkamawaja nuwigtush kumpaji wajuk wetatua tusa ujakmaunash shijash ujaniika.

Jintinkagtin uchin papii takatain tinamui.

Waji atsumnawa

Chigki kuntin aidaun dakumjamu.

Uchi kuntinun achiktatus jintaá aintug wekaesamu dakumkata nuniakum kumpajum ujakta wajuk kuntin pujamunmash jegamume.



Kuntin



atsawai.

Aents aidau amukaje.



atsawai.

Aents aidau amukaje.



atsawai

aents aidau amukaje.

Yamaik kuntin tagkuma

ajak aja yuwami.

Ejesmamu unuimagmi

Jintinkagtin ujamau

Ejesmatai papii muun wegkagmanum agagbaun uchin iwaintawai.

Jintinkagtin yaigkam uchi agagbaun aujui.

Jintinkagtin ejesmawai uchi antuinawai.

Iniimui:

- Ejesmataish wajina pachis tawa.
- Kuntinush wajukenawai tawa.
- Wagka tuyasash kuntinnash maache.

Uchi aidau ejesmawai jintinkagtin ejesmamun antukag.

Uchi aidau yapinum atektumatai jukiag papii takatai pag. K2.

Nunuiyan ejesmamun diisag dakumkagtuinawai.

Tuwi takanua

Ayamtainum.

Waji atsumnawa

Ejesmatainum dakumjamu.

Jintinkagtinjai ejesmatai ausata.





LLAMA



VICUÑA



PELICANO



GAVIOTA



Daag:



KASHAI



YUGKIPAK



BASHU



CHINIM



Daag:

Kuntin chigkijai juti ikamjin nuwigtush tikish nugkanmash batsamin

Jintinkagtin ujamau

Muun ujakbau asag kuntin ikam ayaun aneaku ainawai.

Uchi aidau, kuntin, chigki aidau daajin aneakmaujin adayainawai, nuniak waji kuntinnak, waji chigkinak shijash wakenaita nuna etsejui.

Wagka kuntinnash wakegainawa nuna etsejuinawai.

Papii takatai 81, 83 uchin tinamui kuntin dakumjamun takatai pag. D1 awi tsupig anujati tusa.

Anuja umikag aujuinawai nunik jee juinawai patajin inaktak.

Jintinkagtin amaá nunuiya kuntin dakumjamu tsupigta.

Antukta jintinkagtin augbau nuniakum kuntu pachis ausa nunuiya anujata.





Daag:

Unuimagbau iwainmamau

Jintinkagtin ujamau

Jintinkagtin uchi aidaun anentaimtikawai wajina takasagmayi.

Kumpajijai augmattsagtatui wajina takasagmayi nuna.

Yamai ame dakumkata tita wajina wakejusash takasajiawa.



Three horizontal dashed lines for writing practice, located to the right of the girl's illustration.





lina takataiji aidau

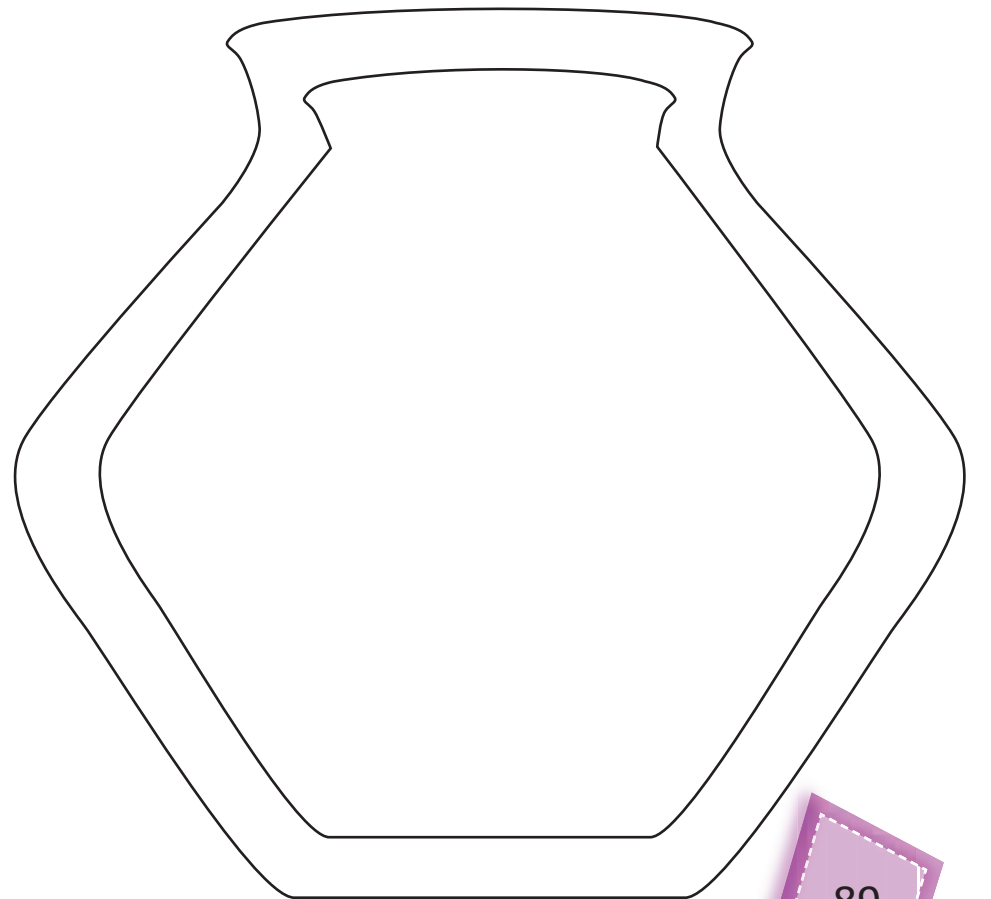
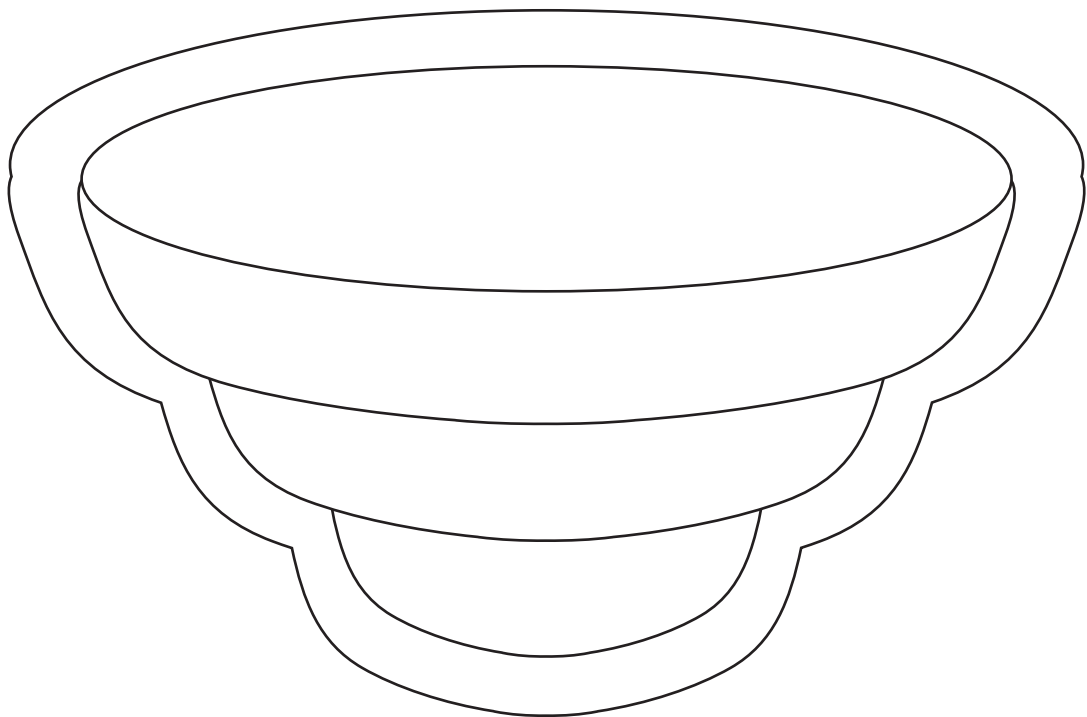
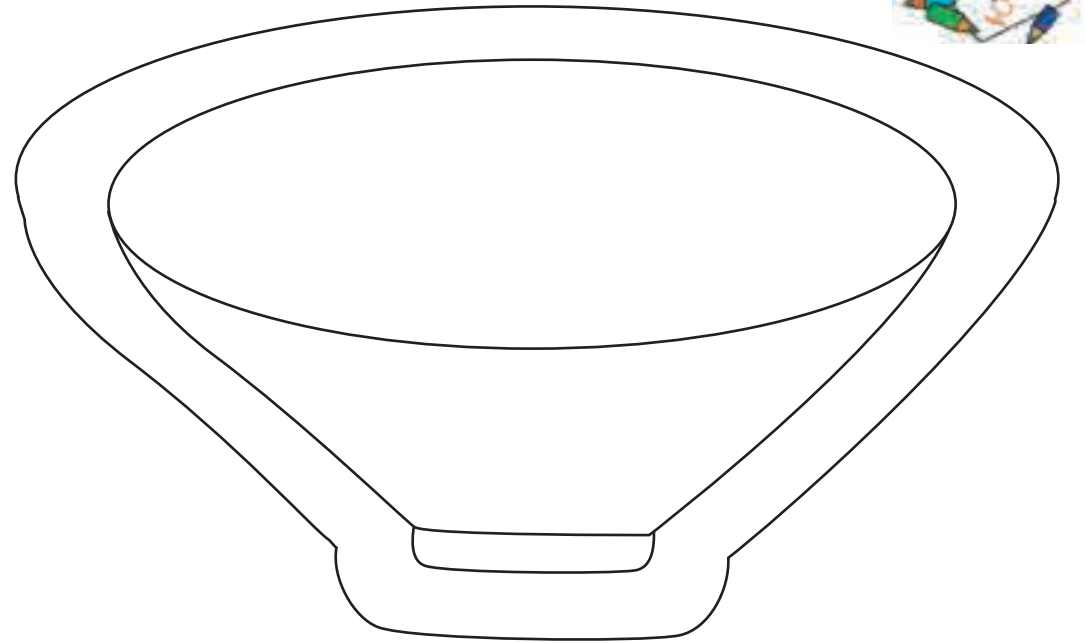
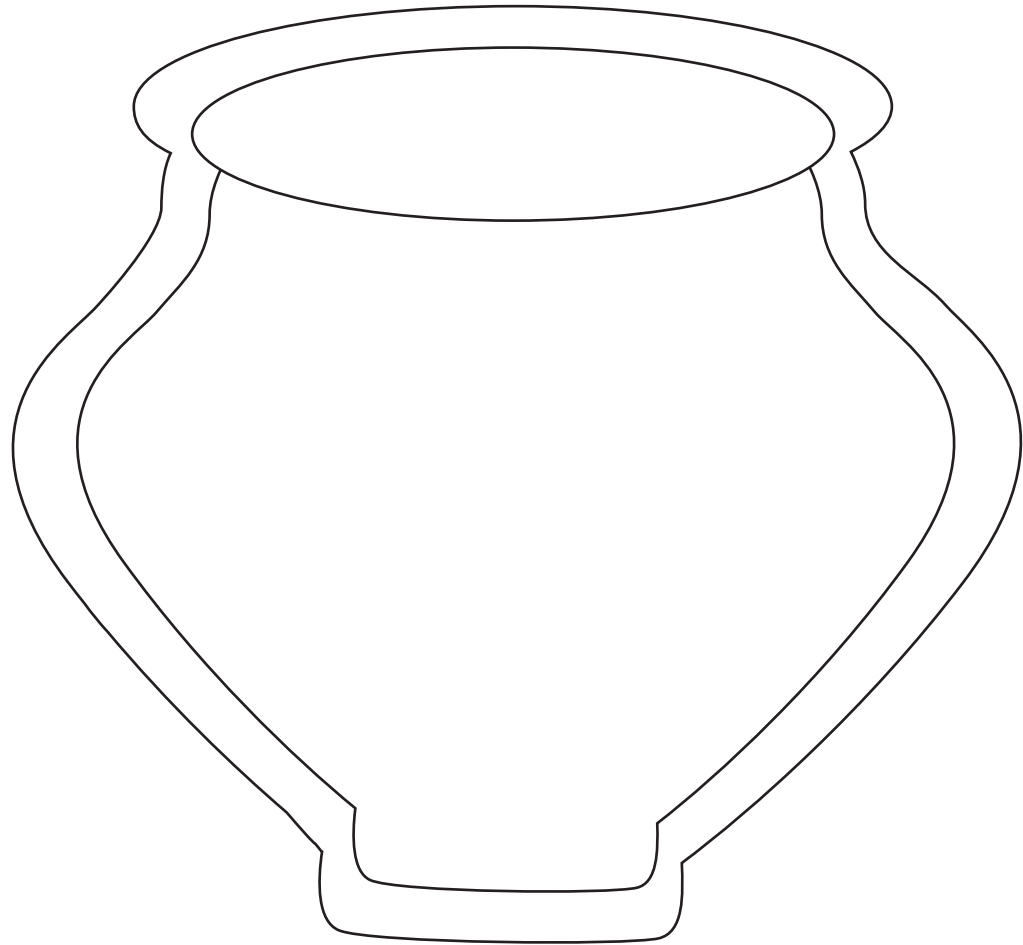

Daag:

Duwejai awantua najanat

Jintinkagtin ujamau

Jintinkagtin uchi aidaun iwaintawai pinig, buwits ichinak, amamuk najankamun jaashjai dukukbaun.

Uchi aidaun iniamu: jusha wajimpaya.

Uchi aidaun niimen diisag adayinawai.

Dukukbaun ujak pujusag chichainawai.

Dukuju jeen wegag antuinawai ichinak, pinig, amamuk buwits takat aidaush wajuk najanamuita nuna pachisag.

Dukug iwainawai maki makichik nuniak agawai daajin.

Ayamtainum jegawan adayainawai waji aidauna dukujush iwainakme, agatkamujin diisag augmatuinawai. Wajinma takataiyaita.

Jintinkagtin inimui:

- Amina dukush wajina takauwe.

Uchi aidaun etsejuinawai pinig wegantu daaji aidaun, diita jeen aun, wajinmak takatai ainawa.

Tinamui papi takatain jakitajai apatuk.

Yaa yaimainawa

Dukuch.

Tuwi takanua

Dukuchi jeen.

Waji atsumaji.

Makichik pinig, buwits, ichinak, amamuk.

Jakitai jukim, niime diisam jakimtijata iina takataiji aidaun.





1. Wajiyai pachimtaiyaita wegkuka yutai najanata takuish.



2. Najanatag takuish wajii atsumnawa.



3. Wajukmainkita etsanum anagchamash.



Najanami iina takataiji aidau

Jintinkagtin ujamau

Dukuju jeen wenawai ujatkatu tusa iina takatai aidau wajak najantayaita, nuwigtu waji atsumtayaita najanatagakuish, junash yaa najannaita, wajak takatayaita pegkeg jinkiti takuish.

Ayamtainum jegawag uchi nuwauch, aishmagkush aidau batsamas etsejuinawai dukug ujakbaun.

Jintinkagtin inimui:

- Yaa najanua, duwejai takatai aidanash.
- Duwesh wajijaiya pachimtayaita.
- Ju najanatagakuish waji atsumaji.
- Wagka etsanmash jitayaita. Etsanu jiyashmash wajakmainaita.

- Waji ukatnawa pegkeg winchagpatin ati tusaish.
- Wajiyai aganua.

Jintinkagtin uchin papii takatain tinamui.

Yaa yaimainawa

Dukuch.

Tuwi takanua

Ayamtainum.

Antukta jintinkagtin chichau, dutikam aikta.



Three horizontal dashed lines for writing.



Anentaimsa adaiyat

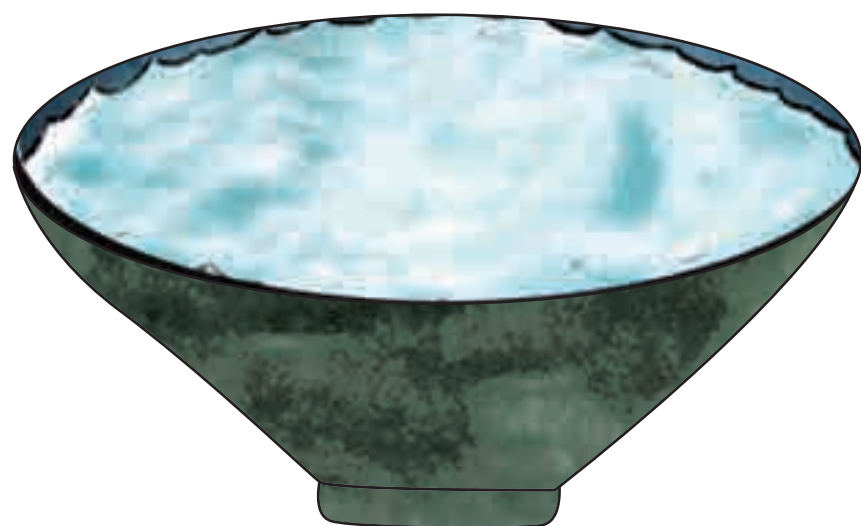

●

Daag:

Anentaimsa adaiyat jiiikmi

Jintinkagtin ujamau

Jintinkagtin ujawai uchi aidaun anentaimsa adaitan:

Shuwiknush wajaknaitjai.

Tujash yumi yajawag mama

inagkag yujin ainawai.

Wisha yaitja.

Jintinkagtin anentaimsa adaitan jiiiktatus anentaimui uchi aidau diita jeen pujusag inimsatnume tusag.

Jintinkagtin anemtikawai anentaimsa adaitan.

Waji daajig ujamait sui ayatak wajuk jiiitayaita duke tunawai.

Pinig dakumkamun iwainawai nunik niimen diisa augmatui.

Jintinkagtin uchi aidaujai anentaimainawai ditash wajuk jikiagtatua.

Pumpunmamunum jintinkagtin agawai uchi aidau adaitai.

Agagbaujin awagsag aujui uchi aidau adaitugbaun.

Jintinkagtin uchin papii takatain tinamu.

Waji atsumaji.

Papii tsupikbau yajaumutai, shikika umutai, pinig shuwikin, buwits.

Agagta ame anentaimsa najanamujum.



Three horizontal dashed lines for writing.



Daag:

Shawinmaya takataiji ainau najankamuji dekaami

Jintinkagtin ujamau

Jintinkagtin tinamui dakumjamun pag. 97 awa nuwiyau.

- Pachimka batsatain uchi iwainak takainawai, niimen diisag.
- Dakumkamun iwainawai, jutinu najana takatai aidaun.

Jintinkagtin iniimui:

- Jusha juti takataijijaish betekaik.
- Wajukujiya betekaita.
- Wajiya betekchauwaita.

Papii muunnum agagta uchi adaimau.

Jintinkagtin, uchi ijumag ujawai, shawinmaya aents aidauk duwejai najambaunak kayana tinu ainawai tusa.

Shawinmaya aents aidauk jutijai betekai, nuniatak ditash batsamin ainawai, peru nugkenig.

Kayanash muuntash awak.

Awai Kayana apuush antsak yaigchish.

Kayana muunumak, kuntu neje ashi yuwatnun ukuinawai, untsuk yaigchinmak, makishkiti yutain juug ainawai.

Waji atsumaji.

Kayan tutai pinig.

Pachimja batsakam anujata, dutikam augmattsata dakumjamu.



Three horizontal dashed lines for writing.

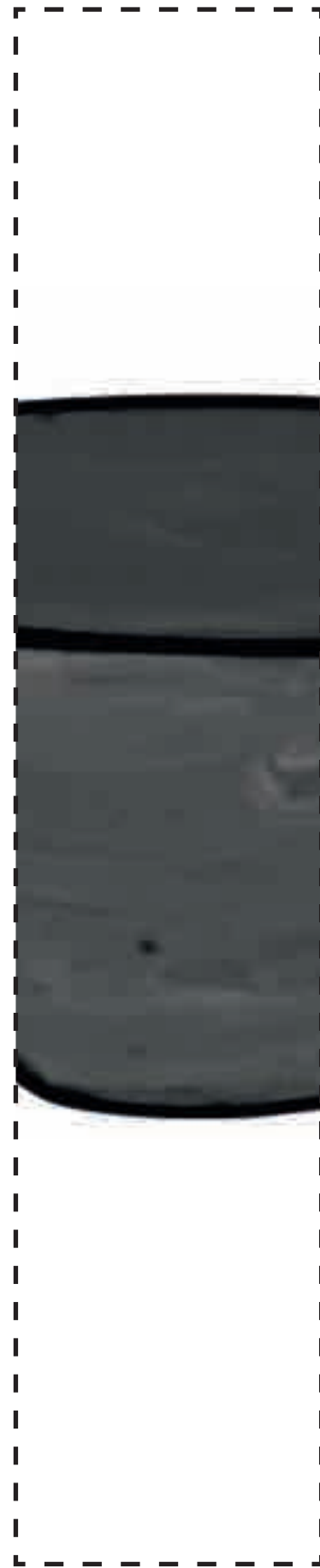

Shawinmaya takataiji ainau najankamuji dekaami

Nuwauch Ana kajamjamu

Anag mijanji ajawai yuk. Senchi wakenai papin ausatatus, tujash dakitin pinig, ichinak aidau najantan.

Anag dukuji shiig najannai pinig aidaun, nina jeen takastinun. Najanak pujus Anág tukee untsuawai, wajuk takasa najankuiya pegkenchish jii-mainaita nuna antuk unuimagti tusa.

Tujash nuu tamash puyatjus antachu nuniak uwejijai ima senchi wasugkamu, nuniak dukujin tawai, wagka tikish aidaush najanainatsua, ayatak *plastico* najankamuwai egkeg yuinawai, au ima pegkejai wamak dijaja uminka tewa wasugmainai tau.

Tutai apaji tawai, antukmajai *radio* num, *plastico*, *botella* ainau takamait sui senchi nugkan ebeseawai tamaun. Tutai Ana chichak, chaa ibau muun ina ikaamji awa nunash wajuk ebesatki tau. Tutai dukuchji antuk, diik Anag au jimá gma waja nuna ukuwen weme diisia wajukukita tau.

Tima Anashakam jegan diikma cha tsuwat wainka

iikmakmaun wainkau, nuwig wajaig tikish pataa

tsuwat peegchaun juki minaun wainkau, tuja

numiauchik tuke jamamtin wee wajau nuu iman

yantamen utuatkam, ashi wainak taa kanak,

kashi kajamu.

Niina pujutaijig ayatak tsumain peegchau

botella, *plastico* wegantu tepetag wegajun,

shiig aneasaikesh yumainchau, paan etsash

bushapau, imanun kajamag ishamak shintaju,

nuu ishamkamuk dukujin jegajua, dukawa

dekas jintinjuata pinigkush najanat imanun

kajamjan ishamkajai tiuwai.

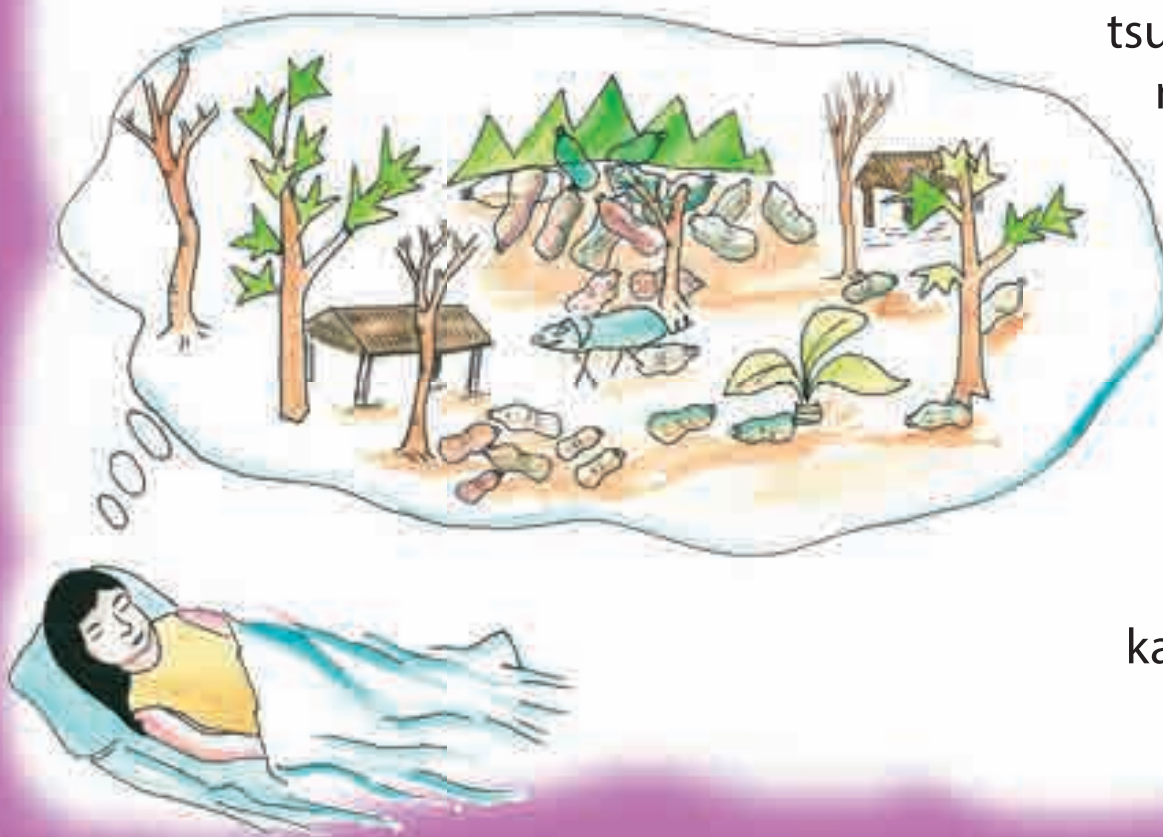

100

Nuwauch Anasa kajamjamu



Anasa wajig shijash awagmatsua.



Jimágmash wajukat wajayi.



Jimágmash wajautinish wajig jayi.



Three horizontal dashed lines for writing, enclosed in a purple speech bubble shape.

Daag:

Nuwauch Ana kajamjamu

Jintinkagtin ujamau

Jintinkagtin tinamui papii takatain pagin 99
augmatbaun jiktinme tusa.

Jintinkagtin uchi aidaun ujawai, dekatkauk
wiya ausatjai tusa.

Aujui chicham muun agakmaun nunik iniimui:

- Dekajumek wajina pachisa augmatua.

Agawai uchi adaimaun.

Diipas agag emawai shiig antuktinme tusag.

Nagkanmaunum ausata agagbau.

Uchi nuwauch, aishmagkuch etsejuinawai
augmatbaun.

Aintsag / agtsak takastinun suwawai iniimau
ausati tusa.

Dakumjamu diisam, iniimunmaya dekaskea nunu sapagkeata.





1 tsawan	2 tsawan	3 tsawan	4 tsawan	5 tsawan



1 tsawan	2 tsawan	3 tsawan	4 tsawan	5 tsawan

Daag:

Itugmainaita wajii ibau *plástico* aidaujaish

Jintinkagtin ujamau

Jintinkagtin ayamtainum ejewai juna yajuak: *plástico*, *jiju*, *espejo*, *botella*, kuchag aidau.

Jintinkagtin iniimui:

- Jusha wajimpaita.
- Atumin jeenish junin nimtinush achauka.

Agagta tesamunum uchi adaimau nunikam akanjata tu ainawa *plástico* tuja jiju najanamu aidau.

Uchi wakegainakug dakumain ainawai yantamchijin, jintinkagtin agagmaunum.

Jintinkagtin iniimui:

- Wajukmainkita *botella*, *plástico* wegantu nugka tai yutua dukap tsawan ukukmash.
- Wajukmainkita mama, paampa saepen

nugka tain yutua dukap tsawan ukukmash.

Papii muunnum agagta uchi adayainamu.

Agaa jinkiag, wajuakeawaki wajish pinig), páampa, mama aidau saepeesh, waanum ukúkumash, tusa; nuniak jimag waan najanawag, akanak batsainawai wajiin ajakag saepejai.

Takatainum 103 awa nuna diinawai.

Tseg tsawan wegakum uchi iniasta: tuwaa minaje.

Takasag ejegainawai dekas *botella*, *plástico* wegantu waamak mamuachun, untsu mama paampa saeppeg waamak mamuaun.

Waji atsumaji

Plástico tsaikbau, *botella*, kuchag.

Dakumkata ájaka (mama, paampa) saepesh, wajuk yapajinae yuminum egkeamash. antsak dakumkata *botella*, wajuk yapajinae yuminum egkeamash.



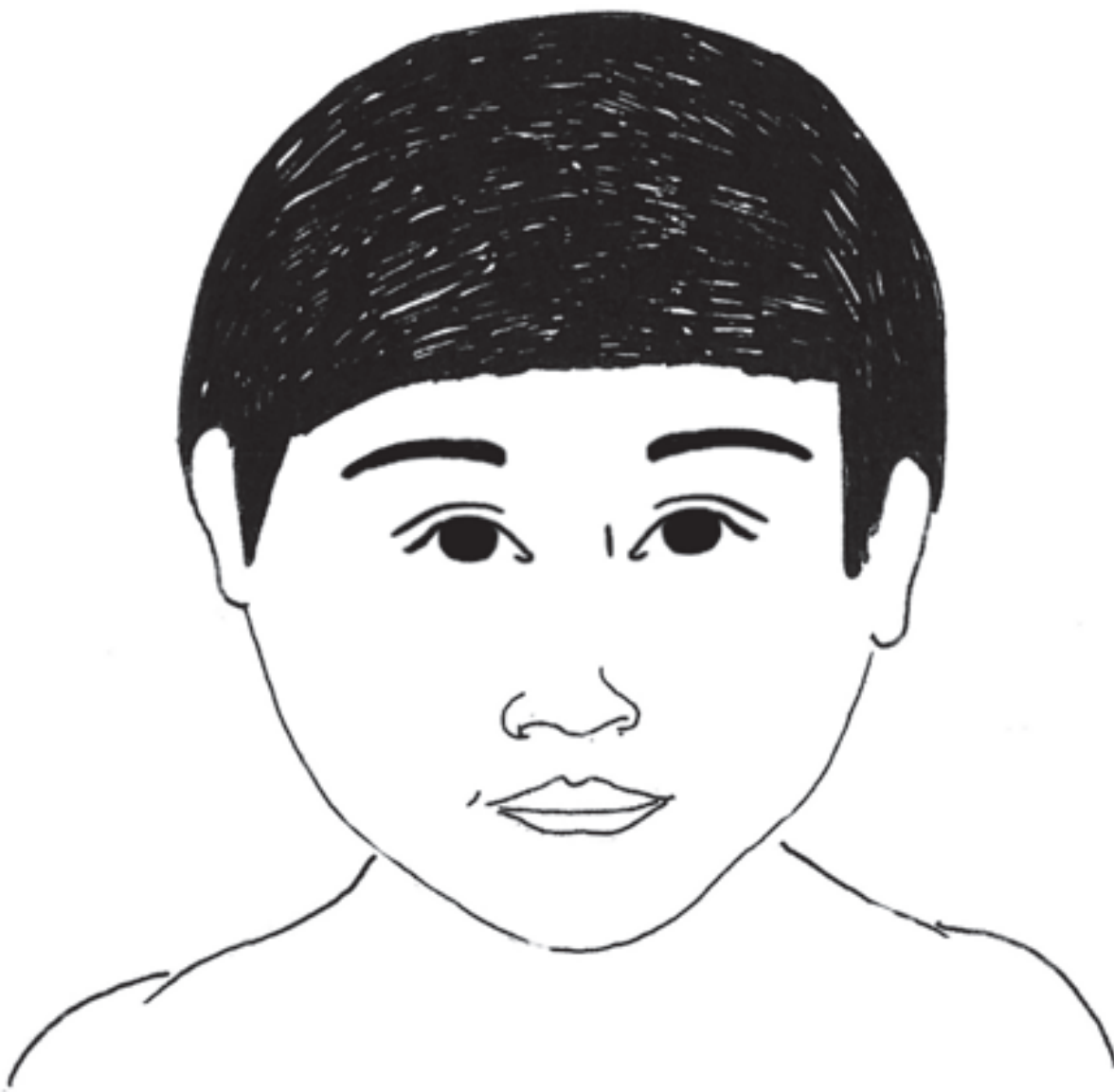

Daag:

Iina takataijai najankamu agattaiji

Jintinkagtin ujamau

Jintinkagtin iwainawai pinig najana agatkamun.

Jintinkagtin uchi aidaun iniawai:

- Juu agatkamua aanush tikishnumash wainkamugmesh ajutjamainatsuak.
- Wajiyai agattayaita.
- Iina apajish waji tsawan jegamunma usumame.

Uchi aimiagtai jikatus antawai.

Muunta jeen weenawai jintinjuati tusag. wagkag nuwash tuja aishmagkush yapinish usumaash wajakuita.

Ayamtainum wakitkiag uchi aidaun iniawai:

- Wajuku asantaiya yakamaush ainawa.
- Tuu iyashnuma yakamau ainawa.
- Tujash wajuk yapinish agamau ainawa.
- Aishmagkush yapinish wajuk usumawajakuita.
- Ipakush wajiyai pachimnawa usumagtashaish.

Jintinkagtin takatain 105 suwawai pachimja takastinjai.

Waji atsumaji

Jampu, ipak, suwa.

Dakumkamu usumtijam, augmattsata wagkag usumin aajami.



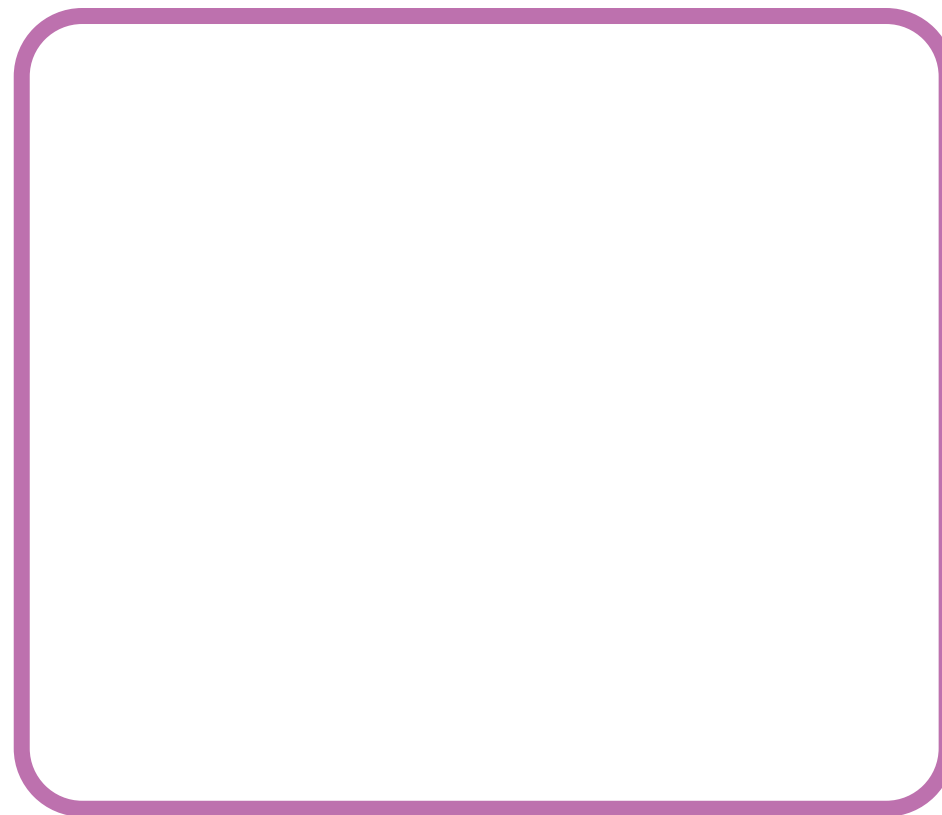

Daag:

Duwe pachiamu jakimtiktaijai

Jintinkagtin ujamau

Ipaji makichik dukug ujajatkati tusa duwesh wajuk pachimtayaita najanatagtakuish.

Uchi aidau pujusag diinawai, nuniak yaimai nawai dukug atsumak segamtai.

Duwe pachigbau kashin takastinum dukai ijia ukuawai.

Ayamtainum juwawai duwen.

Jintinkagtin duwe jukimujin ejega iniimui:

- Duwesh wajiyai pachimtayita.
- Wajukeawa yukukush duwejai pachimjamash.

- Duwesh tikish nugkajaish pachimainkait. Itugsa dekaji duwesh najanmain wajasush.

Waji atsumaji

Duwe, yukuku.

Dakumkamu diis agawai duwe wajuk pachigmauwaita. Augmatui duwe pachigmaush wajukeawa.





Daag:

Unuimagbau iwainmamau

Jintinkagtin ujamau

Jintinkagtin uchi aidaun anentaimtikawai wajina takasagmayi.

Kumpajijai augmattsagtatui wajina takasagmayi nuna.

Yamai ame dakumkata tita wajina wakejusash takasajiawa.



Three horizontal dashed lines for writing practice, positioned to the right of the girl's illustration.





Ajakma juut
unuimagmi



Nuis

Duse augmatbau



Yunuik



Yaunchkek nuwa Yunuik daagtin dusegtin ajaku tuwajame, iman asa tikich nuwa aidaunak aja yuchau tusa dushiki wajaku.

Yunuik makichik tsawantai duse tegai ikaunma agajin anak pujuju. Imatika pujai yumishkam yutug midau nunitai Yunuikchakam jiintuki juwaak wekaetau. Nuwaush Nuis daagtin igkuas tseken tajua dusen ajapaa yuwatatus segau tuwajame, tujash Yunuik sujitkau.



Dutikam wajasa niimkama wainkau makichik duse iyaag tepaun,
Nuischakam wainmauwaik nawen kajut najai wajasu imachik asa
dusegtin jeen wayamun wainak tsajam nawen kaet etea juwakug
pijajin chaat egkea pempenkug jeen wakitkiu tuwajame.



Jeen jega agauchijinig nugka tautus duse ajaya tuwajame.
Nunu tujuagmatai juki ekek ajau, nunashkam aikasag kuitamas
tujuagmatai juki ekek ajau, duwi tujuagmatai aja ajaji ukuaya
tuwajame.

Duwi pujus Nuis duse tujuajun tegaak awajun nuwa aidaun ipaa
tegau tuwajame. Nuniak atumesh jukijum ajamjum ukuajum
yuwatajum tusa tinamkau. Duwi nagkamas duse aja yutanak
uyugkaju tuwajame.

Duse augmatbau

Jintinkagtin ujamau

Jintinkagtin uchi papii takatain tinamui nuniak iniiawai:

- Wajina pachisag augmatua.
- Augmatmaunmash waji nagkaemaunak uapakti.

Jintinkagtin augmatbaun aentsji aidaun, agagbau daajijai aujui.

Uchijai augmatbaun aujui.

Jintinkagtin iniawai:

- Yunuik, nuwa aidaunash waji tinuk ayi.
- Wagka Yunuikash sukagtutnash dakitnush ayi.

- Yunuik duse sujtkamash Nuisash wajuk anentaimsauk ayi.
- Nuis, duse jigkayi jukish utugkauk ayi.
- Amesh yatsumjaish, kumpagmijaish ajamdainukum, waji ajamdainume, ii takakbau ajamdaisashmash wajukmainkita.

Jintinkagtin uchijai augmatui ajamdaitan pachis nuwigtu ii dekamu tikish aidau jintintak.

Jintinkagtinjai duse augmatbau ausata.





Yutai ajamasa yuwaami

Jintinkagtin ujamau

Jintinkagtin uchi aidaun iniawai. Apash waji takatna takauwe.

Uchi aidau diita patajish nuwigtu tikish aents aidaush wajinak takau ainawa nuna augmatuinawai.

Jintinkagtin iniimui:

- Dukuch ajakmamu juuka yuwakush ajamauka.
- Aents aidau ajamdaitasuk batsatmaunmash wajukmainkita.
- Aents aidau ajamjamainashkuish wajuk anentaimainaitme.

Uchi diita anentaimaun chichainawai.

Jintinkagtin uchin ujawai tikich aentsjai ajamdaita nuna pegkejin nuwigtu ayamtainum uchi wajuk ajamdaimain ainawa nuna pachis.







Uchi aidau kumpajijai yutai itamujin ajamdaiyas yuwinawai.







Jintinkagtin uchin papii takatain tinamui.

Uchi, kumpag. ajampeu dakumkamu diisam, papii nanekbau jukim anutugta.



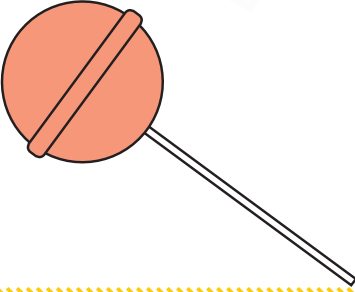

Daag:

Yutai pegkeg aidau

Jintinkagtin ujamau

Jintinkagtin iniimui:

- Yaunchkesh uchi aidaush ajakma juukmaunash ashi yuwash ajabia.
- Wagka yaunchkesh uchi aidaush pagat kegkejaish imatikash yuchaush ajakuita.
- Wagkan junash yuchaush ajabi nuna uchin ujawai.

Jintinkagtin uchin ujawai. Jinta minikman uchi apach yumintsak najagkamun shiig kuwashat bukunaidaun wainkamjai.

Jintinkagtin iniimui:

- Atumesh yumintsak aidaush yuuk agmujum. Iina iyashinish yaijatuash.
- Wajukmainkita ayatak yumintsak aidauk yuwamash.

Jintinkagtin, uchin ujawai yutai pegkeg aidau yutan, nuwigtu ujawai wajinak, yaunchuk muutash waimaktasah yuchaush ajame.

Jintinkagtin iniimui:

- Wajukmainaita yutai pegkeg aidau yuwashkuish.

Uchi diita batsatkamujin yutai aidaun adaiyainawai.

Jintinkagtin uchin papii takatain tinamui.

Dakumjamu diista nuniakum jakimtijata yutai aidau yuwam pegkeg iyashin emau, aniachushkam.





Daag:

Dupa kagakujai wasugkamami

Jintinkagtin ujamau

Jintinkagtin uchijai dupa kagaku aidaun ijumag batsawai.

Jintinkagtin iniimui:

- Wajuk jegamainaita, dupa kagaku inagnaku ijumjamunmash.

Uchi aidau wajuk jegamainaita nunu anentaimaun chichainawai nuniak wasugkamainawai.

Kampatum uchi juunikag, tutupit pekaamak wajainawai.

Dupa kagaku ijumjamun diitak anentaimas nagkagainawai.

Uchi aidau aneenawai yana ukujinik wajasagme.

Wasugkama nagkankamunum jintinkagtin ininawai: dupa kagaku ijumjamu tseke nagkaeku wasugkamaush shiijak awatamka. Nagkanmaunum jegantatamaush utugchatkaik.

Jintinkagtin papii takatain jakiiitjai uchin tinamui.

Tuwi takanua

Ayamtai agajin.

Waji atsumnawa

Dupa kagaku.

Dakumjamu shiig esettsam diisam sapagkeata amesh tuwi wajamume nunu.



Three horizontal dashed lines for writing, located to the right of the girl's illustration within the same rounded rectangular frame.



A large empty rectangular box with a yellow border, intended for writing.

1

A large empty rectangular box with a yellow border, intended for writing.

2

A large empty rectangular box with a yellow border, intended for writing.

4

3

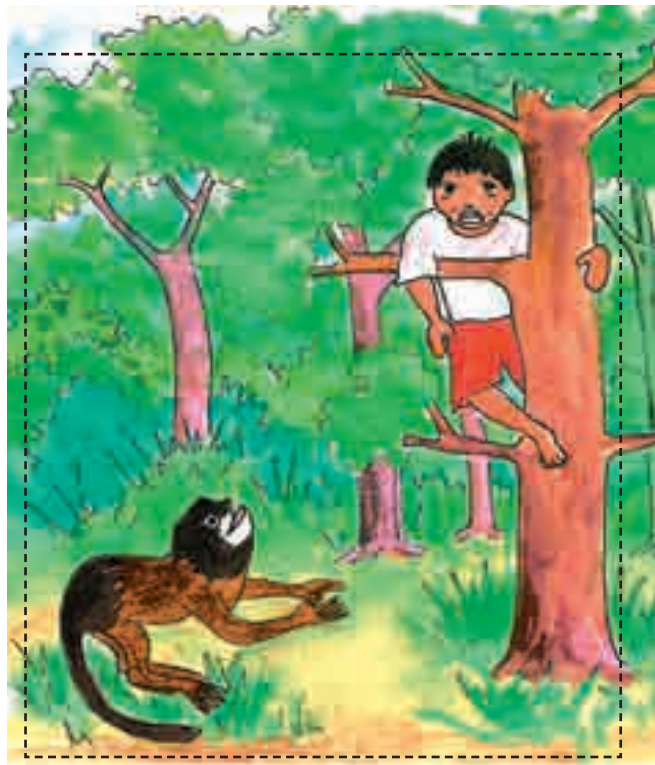
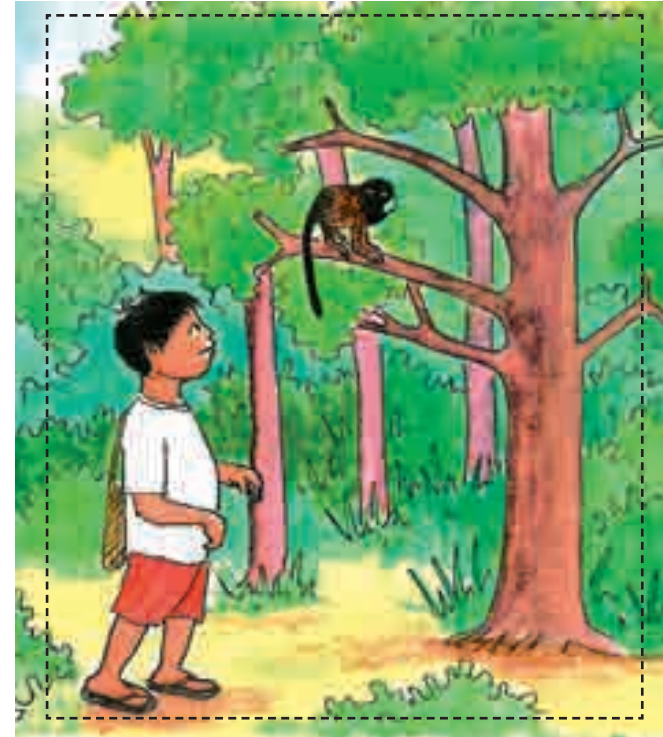

Dakumjamu diisa augmatbau anentaimsa jiikmi

Jintinkagtin ujamau

Jintinkagtin iwaintawai dakumjamun Pág. 125.

Nuna diisam uchi aidau, augmatuinawai.

Uchi aidau augmatbaun, jintinkagtin papii muunum agawai.

Ashi augmatus nagkamkamtai, ataktu diinawai, agambaun.

Dakumjamun jukian augmatbaun adeajan tuwi anumainaita nuna diisan batsainawai pág. 123.

Uchi aidau augmatuinawai dakumjamun, nunik makichik etegkeawai nii aumattsatnun

Tuwi takanua

Ayamtai.

Waji atsumnawa

Dakumjamu aidau, ajatin.

Dakumjamu diisam, augmatbau agagta.



Three horizontal dashed lines for writing, located to the right of the girl's illustration within the same rounded rectangular frame.



Daag:

Jigkai ajake nuwigtu yuwatnush tuwi ukuji.

Jintinkagtin ujamau

Jintinkagtin yutai pegkeg juukbaun antsag besekunashkam inakmawai.

Pegkeg yutai juukmau aidau nuwigtu yutai besekujaish utugtaita nuna pachis uchijai augmatui.

Jintinkagtin iniimui:

- Dukuch wajuk yutai juukbaunash ukuwe, wajukunma.
- Wajukunma yutai juukbaush ukumainaita, wagki.

Uchi aidau diita dekamujin etsejuinawai.

Jintinkagtin yutai ajakmamu juuka ikaunmamuk papagmaunum pataja kuwitamka tsuwamjamu yutayai tusa uchin ujawai.

Jintinkagtin papii takatain T3 uchin tinamui.

Yutai aidau dakumjamun anujata; tuwi yuwatnush ukutaita nunui.



Three horizontal dashed lines for writing.

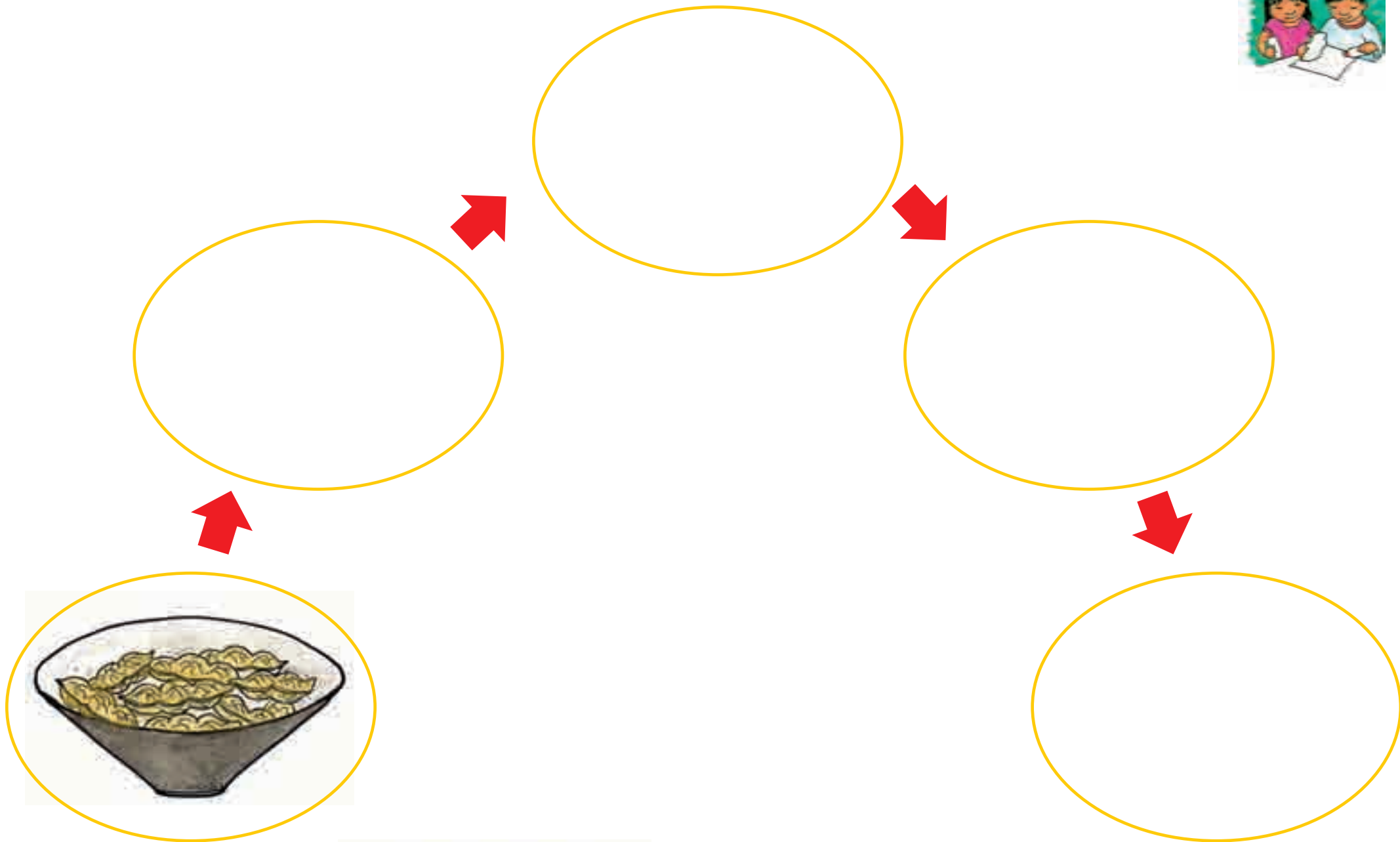

Daag:

Bichak najanami

Jintinkagtin ujamau

Jintinkagtin uchin bichak mamajai
ajampeawai.

Uchi aidau emtin bichakan umiawai dutika
ajamawai.

Uchi aidaun iniawai:

- Wajuk bichakash najantaiyaita.
- Dekatkaush waji takanua.
- Duse najuku, bichak najantaya tusa
ujawai.

Uchi aidau anentaimaujin chichainawai nunitai
jintinkagtin papii wegkagmanum agawai.

Jintinkagtin bichak najanataisaish waji
atsumtayaita nunu aidaun iwainawai.

Uminainawai yajaig juunikash takasagti
nuniak juunik pekajun waji takastin aidaun
aimkagmaun diis tinamui.

Diinawai wajukeawa duse, najuku, aidau
dekegmash.

Bichaknak dukajai ijiawag ukuinawai.

Kashikmas kaunawag bichak ijia ukukmaun
jukiag yuwinawai.

Uchi aidau jimag bichak najanamun yumin
dakitua pachimag diinawai wajuku wajase
nuna.

Jintinkagtin iniimui:

- Tuu bichak wii ajamasmag nujais
betekaita.

Juunika takasmaujjai ijunag chichasag
etsejuinawai pegkennash najanawaja nuniak
tuinawai bichakak najantaiyai duse najukujai.

Jintinkagtin papii takatain pag. S4 uchin
tinamui.

Waji atsumnawa

Duse udu, duse nuwikmau, duse inagkamu,
numi ijuntin, daek, duka, pumput.

Dakumjamu anuja emaku, dekáata wajuk bichakash najantayaita.





1



2



2



1



1



2

Daag:

Ajakmamu juuka sujaji tusa wasugkamami

Jintinkagtin ujamau

Jintinkagtin uchijai augmatui yaa dukug aidauk ajakmamu juukash yaakat sujakush weenawa.

Yabai wasugkamattaji ajakmamu juuka sujamu tusa uchin ujawai.

Yutai ajakmamu sujaku patagtinum etegkeg uminawai.

Yutai jeenian itawaje: paampa, mama, tsabau, kegke aatus.

Uchi aidau yutai sujuktinu daajin akikejai papii tsupigbaunum agatuinawai. Jintinkagtin yutai akike wej nagkaekau ainum tusa diyawai.

Wasugkamak yapag.ainawai. Uchi aishmag nuwauchijai yutai sujin, tikich aidau yutai sumau aidau.

Sumau aidaun sup kuwichik kaya aina nuna nunuiyan tinamui.

Jintinkagtin uchin yayawai shiig kuwishkin dakapag jukiti tusa.

Sumak nagkanainak wajina sumakaje kuwishkish betekash ejeniaja atsa ampinjaegash nuna augmatuinawai. Kuwashat tsawan wasugkama pujuinawai tikich wajin ikaunmawag.

Papii takatain uchin tinamui pág. S2.

Wajupa kuwichik atsumame ajanmaya yutai aidau sumaktasamesh nunu anujata.



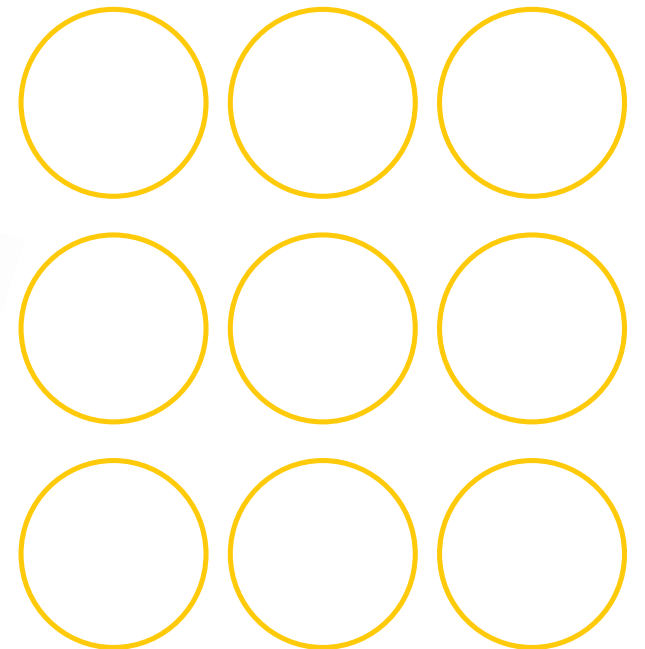
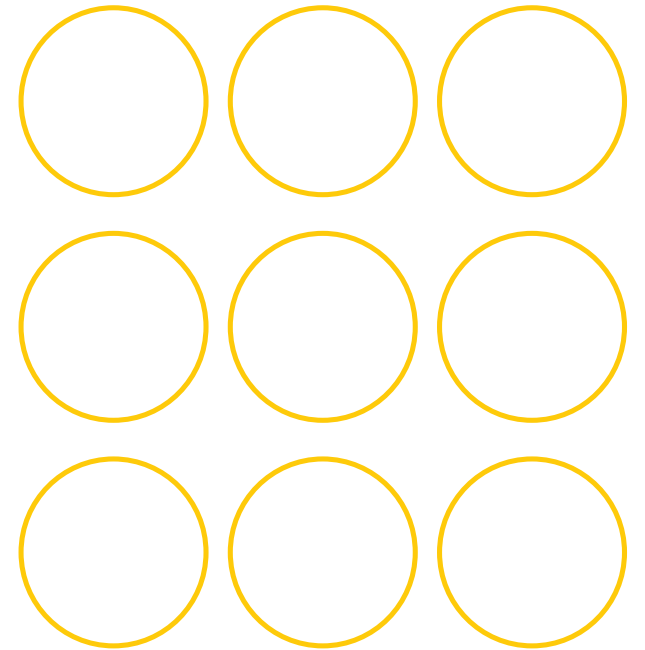

Daag:

Ajak juwaamu wasugkamami

Jintinkagtin ujamau

Jintinkagtin uchijai chichawai wajuk ajakmamu aidaush juutaiyainta nuna pachis

Uchi ajakmamu juwaaku wekaesamujin augmatuinawai.

Jintinkagtin uchin iniawai: wajuk ajakmamu aidaush juumainaita.

Uchi aidau diita etegkenawai wajuk ajakmamu juumain ainawa nuna anentaimas wasugkamatatus.

Uchijai papii tsupija ajakma yutai aidau dakumjamun nugka batsawai.

Uchi maki makichik nawejai kampakum ajakma yutai aidau juwaawai.

Ashi juuk wajanta adaiwai yutai daaji aidau, nuniak wajupa juuke nuna dekapawai.

Uchi aidau tuu nawejai yutai papinum tsupija dakumjamunash juuke nuna etsejui. Nuwintush utugchatash dakapsama nunashkam etsejui.

Papinum dakumainawai ajakma yutai aidau juukmaun. Uchi wasugkamami tusa segamtaik pataksag wasugkamainai.

Jintinkagtin uchin papii takatain tinamui.

Dakumjamu diisam,wajupa yutai juukbau waigme nunu jakimtijata.





Papai



Idauk



Pituuk

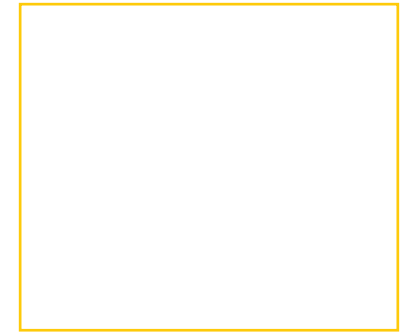

Pitu



Pagat

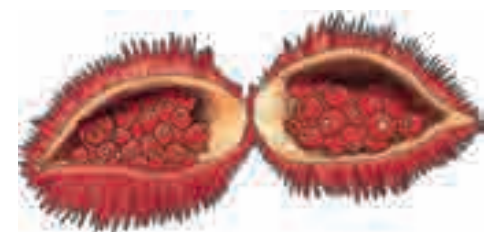

Ipak

Chicham nagkanmauji betek aidau egakmi

Jintinkagtin ujamau

Jintinkagtin takatai dakumjamum uchin tinamui, nunik tawai shiig esettsam diista, nunikam dakumkamunmash waji wainme daaji adaikata.

Uchi yujagke daaji adaiyainak ejegainawai dekatkau adaimaun. Nunik tikish yujag, kuntin, namak, aents ainau daaji adaiyam nunu betek nagkamnaun ejegainawai.

Tuwi takanua

Ayamtainum.

Waji atsumnawa

Papii tsupija dakumjamu daaji adayam, betek chicham nagkanaidau aidau.

Achimtikata daa betekmamtinun naamkau aidau nuniakum waji atsawa nunu dakumkata.



Three horizontal dashed lines for writing practice, positioned to the right of the girl's illustration.

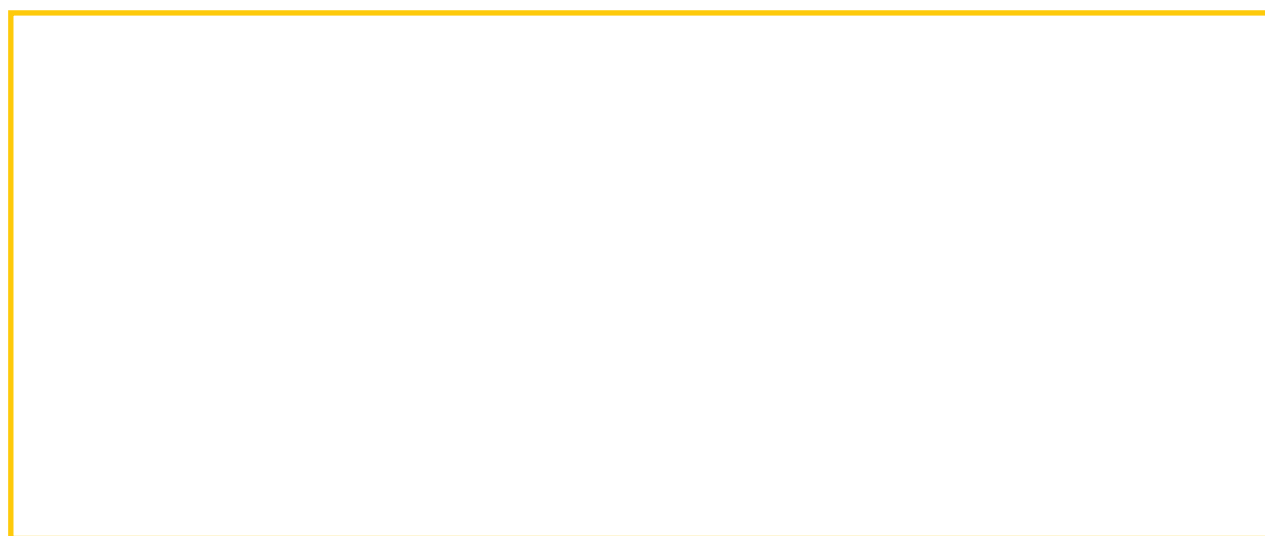
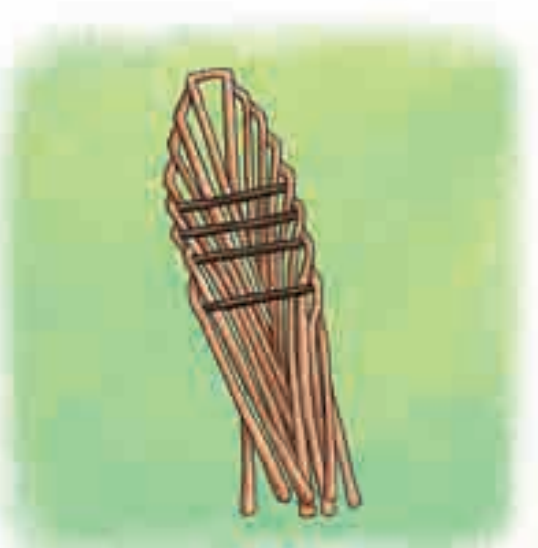

Daag:

Japa nawe najanami

Jintinkagtin ujamau

Jintinkagtin uchin inaktawai tsanimpa duke kagkajin kagakun nuniak iniiawai jujaish waji najanmainaita.

Wajupa tsanimpa duke kagkajin takamainaita.

Uchi tsanimpa duke numijin dakapag akanak batsawai.

Wajupa muunta japa nawesh najanattaji.

Jintinkagtin kam japa nawe tsanimpa duke kagkajin najanamun inakmawai.

Uchi aidau etegkenawai wajupa najanattawa nuna.

Najana emainak tsanimpa duke kagkajin dakapag batsak emainawai.

Uchi aidau tsanimpa duke kagkajin kagakun wej dakapag japa nawen najanainawai.

Jintinkagtin papii takatai uchin tinamui.

Tuwi takanua

Ayamtainum.

Waji atsumnawa

Tsanimpa duke kagaju kagkaji.

Achintikata wajupa tsanimpa duke kagaju kagkajijai japa nawesh najanamume nunu.





Daag:

Unuimagbau iwainmamau

Jintinkagtin ujamau

Jintinkagtin uchi aidaun anentaimtikawai wajina takasagmayi.

Kumpajijai augmattsagtatui wajina takasagmayi nuna.

Yamai ame dakumkata tita wajina wakejusash takasajiawa.







lina muunji takatai
najankamu dekaami

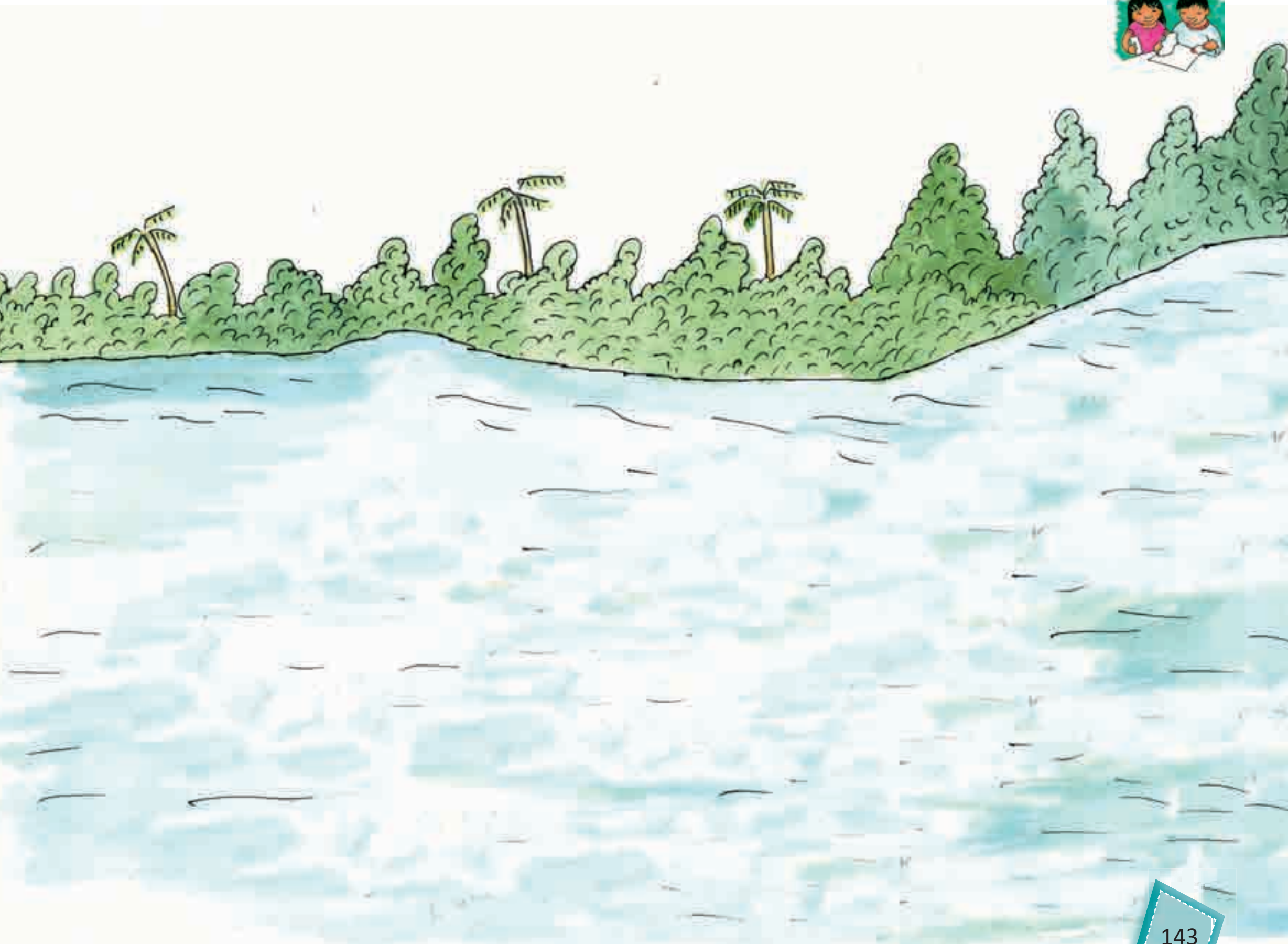

Daag:

Namak mina nugkajui ayamu dekaamu

Jintinkagtin ujamau

Jintinkagtin iniawai:

- Waji namaka wainin ainagme.

Maki makichik uchi aidau dakumainawe papii pujunum, apajish waji namaknak mainiawa nuna.

Kumpaji aidaun ujawai namak dakumkamujin.

Uwejin awatkiag namaka daajin adaiwai chichaman akanag. Nuwigtush tsekeakush takamainai.

Uchi aidau etsejuinawai ditash namaknash itugka inagkamunak yuwatasash wakeyin ainawa.

Takatai tinamui dakumjamu diisag ejeti tusa.

Namaknum anugjata namak aidau dutika tenteata namak amina shiig awatamu.



Three horizontal dashed lines for writing.

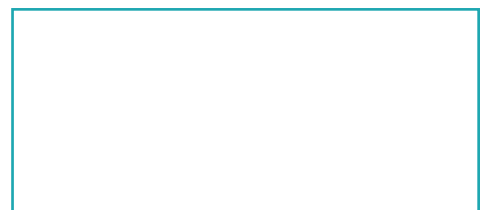
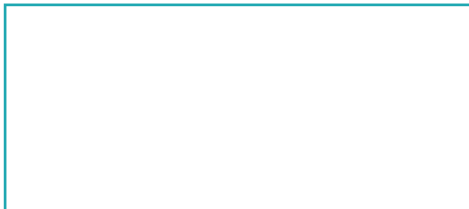
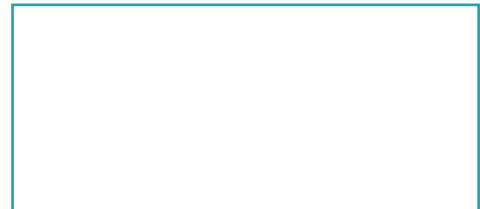

Daag:

Namak wasugkamami

Jintinkagtin ujamau

Papinum najanainawai namakan nuniashkush dukanum. Makíchik uchi najanattawai wej namakan.

Chichaman uminawai wajuk wasugkamawagtatua.

Aga jinkiag egawai agkantun namak najankamun batsastatus. Namak kakajus maumainun etegkeg umiawai.

Maki makichik uchi batsatui ditash ajuntuk mawagtatus. Ayatat ajuinawai kam ajunkati tabau.

Ijunag batsamas dekapainawai wajupa namaknash maawaje.

Ejeyinawai yaa kuwashtash mae, yaa ujumchikesh mae, nuwigtu yaa betekash mae namaknash.

Jintinkagtin tinamui papin.

Waji atsumnawa

Kam uchia nunu tinamkata maki makichik agsea.

Namak nish nimtin aidau uchi najankamu. nuniashkush dukajaish najanamu amainai.

Amainai kam namak najanamu.

Dakumkata namak wajupa mamume. Dutikam kumpajum ujakta.



Three horizontal dashed lines for writing practice.



Daag:

Iina nugkenish namakash wajuk mautaiyainta

Jintinkagtin ujamau

Jintinkagtin ayamtainum juwawai agsean nunik uchi aidaun iniawai.

- Yaa agsea takatnash dekawa.

Uchi aidaun augmatuinawai diita agseajai ajunbaun.

Uchi aidaun iwainawai wasugkamainak diita apajish namaka maatasash wajuknuk ainawai nuna pachisag.

Jintinkagtin inimui:

- Namaknash wajuk mainawa aishmagkush. Nuwasha.

- Uchish namaknumash wajukeyawa.
- Wajinak takaush ainawa namaka pachintakush.

Apag muuntan ijajainawai namak main atasaish wajig takataigkita nuna ujakati tusa.

Dakumkata wajina takau ainawai namaka matasash amina nugkeminish.



Three horizontal dashed lines for writing.

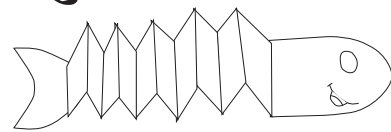
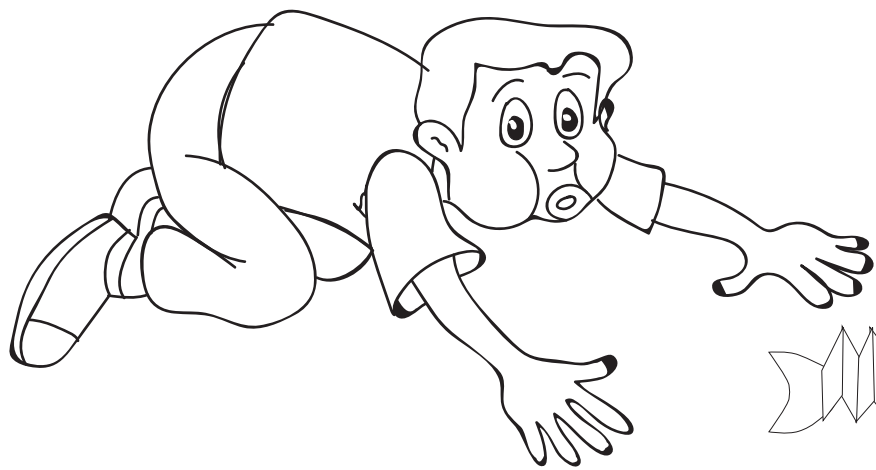
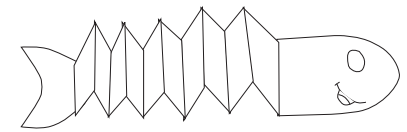
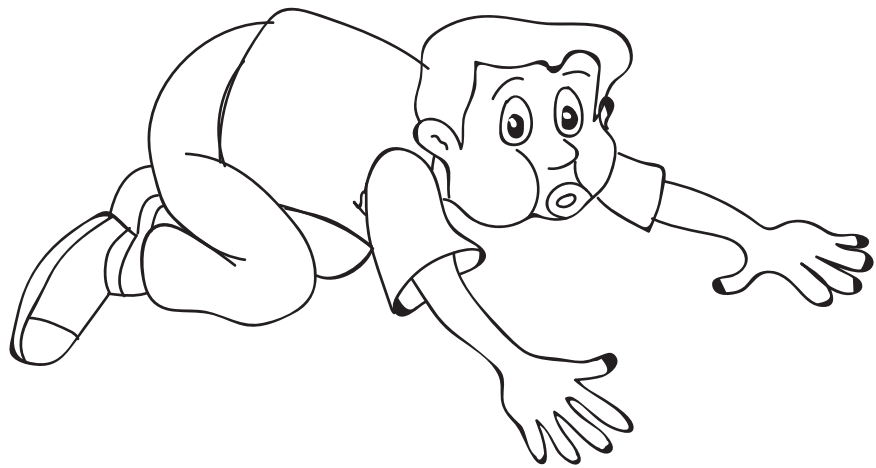
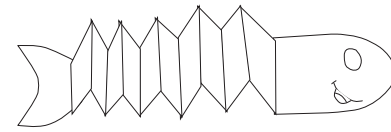
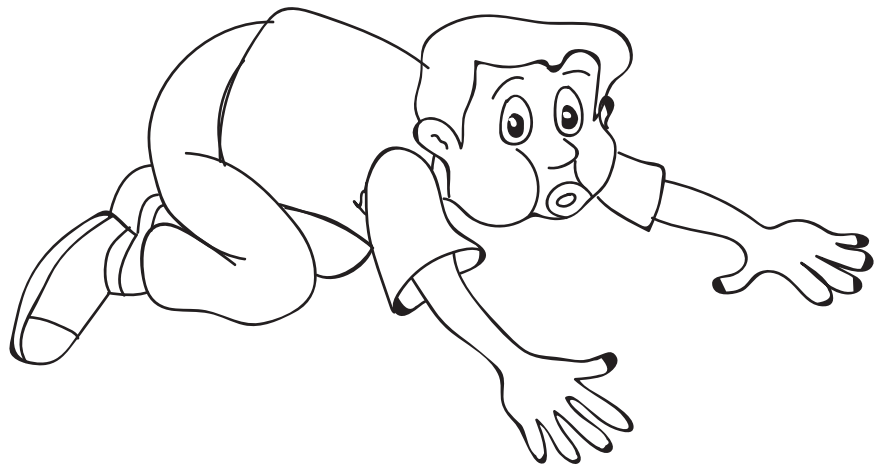

Daag:

Namak pachisa wasugkabau

Jintinkagtin ujamau

Jintinkagtin tinamui namak dakunjamun pag. T5 nuniak ujawai papin ninukti tusa ijugbau diisag ninukta tusa.

Jintinkagtin uchi aidaun iniawai, itugmainaita namakash ekemkati tusaish.

Uchi aidau etegkenawai diita namak ninugbaujin, nuniak anentaimui tikichish wajuk najanmainaita nuna.

Jintinkagtin ujawai uchi aidaun, wasugkamami kagka tupikamu, tujash achitsuk umpuijum ekektajum tusa.

Uchi agkan batsamas diita etegjamun wasugkamainawai.

Dakumui nugka tsentsakag. Dekatkauk tuwi juwaki wetatji, tuwi wegakuiya inagnaktatji.

Ijumui kam uchin.

Maki makichik etegkeawai namaka niimen diisag.

Maki makichik juki namakan apujui tsentsagbaunum nunik umpuiniag emainawai.

Kuwaegak wegamunum jintinkagtin tawai anig wajantajum tusa, iniawai yaa pujawa, eemkash, inagnamunmash.

Amina namakjumesh wajinma pujawa eemkag, ejapenag atsa ukunmag.

Aanik wasu wasugkamainakua jegainawai diita mamikjamujin.

Uchi aidau etsegtumainawai yayaa tantae tusa.

Dakumjamun diyawai. Jakimtijata samekbauyai deatkau awa nunu, wigkayai inagnamu awa nunu.





Namak

Duka tiig

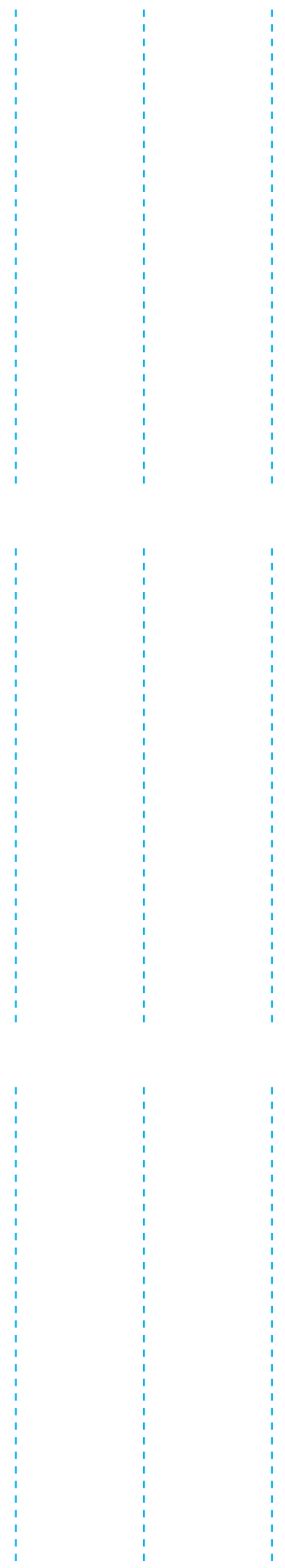

Unuimagmi yugkunamu inajut

Jintinkagtin ujamau

Iina dukuji ipaji yugkunamu inagtan jintinjamati tusa.

Ijunag chichainawai ditash wajinma yaimkagtatua nuna pachisag.

Jitus antuinawai dukug etsegtai, etegkenawai namakan antsag dukanash, kuwitamas dukug tibaun yugkunawagtatui.

Takasa wegamunum ujawai wajuk yugkunaish yutaiyainta nuna.

Iina dukuji jintinjamui itugsaiya dekaji yugkunamu najukush.

Najukmatai yuwatatkuik dekatkauk ikigmaja yutaiyai.

Anenawai dukuji ujakbaun.

- Waji atsumaji namaka yugkunatasaish.
- Wajuk takasa inagtaiyaita.

Chichaman umik, atak adeagtinun againawai.

Anentaimainawai agajagmi tusag.

Papii pujun jukiag takainawai dakumjamu diisag.

Umikta wajuk yugkugkash yugkuntaiyainta.



Three horizontal dashed lines for writing.



Daag:

Uchi tsakat namakan yumainchau aidau

Jintinkagtin ujamau

Jintinkagtin ipawai dukujun ayamtainum taa ujakti tusa uchi aidaush tuu namak aidaun yumainchau ainawa nuna pachis.

Uchi aidau inimainawai ditash shiig antukagtatus.

Jintinkagtin iwaintawai nnamak dakumjamu aidaun. Uchi aidau etegkenawai diita namak yumainchau aidaun.

Jintinkagtin anémtikawai uchik, baupts, pepen aidaun yumainchau ainawai, atak muun wenakush wajukmain ainawa nuna diisag.

Uchi aidaun jintinkagtin iniawai tikish namaknash ditash dekainatsuash yumainchau aidaunash.

Yaa yaimainawa

Makichik dukug.

Waji atsumnawa

Namaka wakani dakumjamu pepen, baupts, pepen niish nimtin aidau, kagka, tujushik, kusea, tugkae, mamayak, tsutsum, pani.

Ejeta dutikam jakimtikata, uchiiti namak yumainchau aidau.



Three horizontal dashed lines for writing.

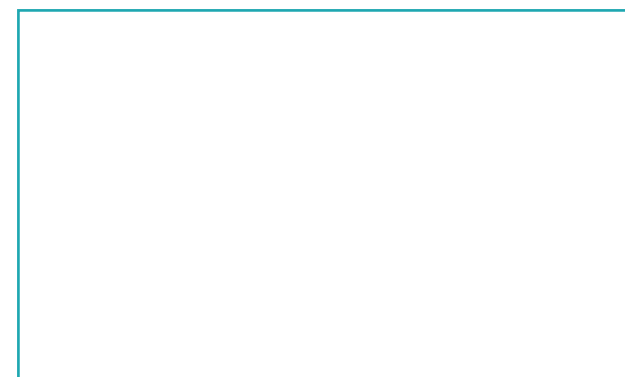
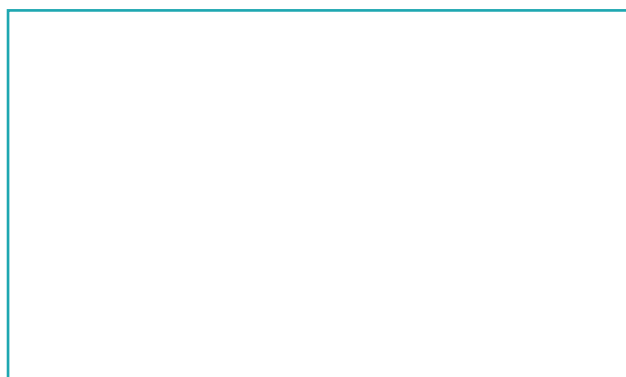
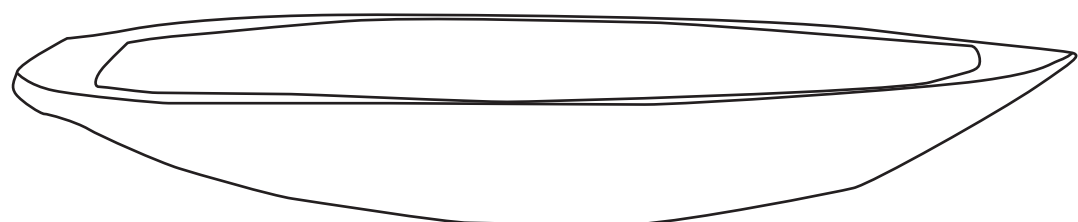
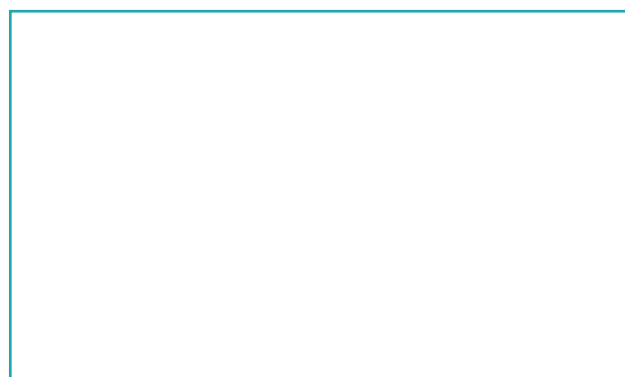
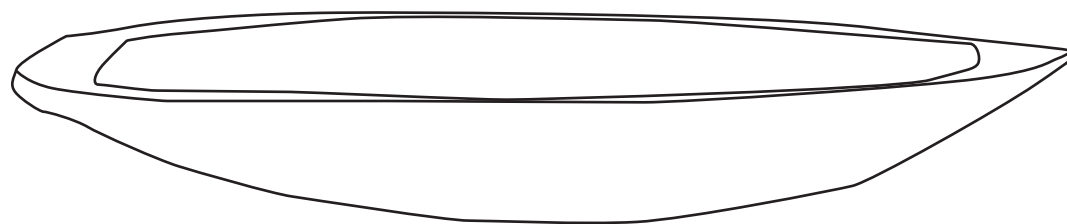

Daag:

Kanunum wekaesami

Jintinkagtin ujamau

Jintinkagtin uchin iwaintawai wej shimpi
wagkujin dutika uchi aidaun iniawai, juu
wagkujiya juwish wajuk wasugkamtaiyaita.

Uchi aidau iwainawai wasugkamtain.

Chichaman uminawai wajuk wasugkamattawa
iyashin umimtiktsukesh kumpajijaish.

Nina kumpajijai yapag.awag
wasugkamainawai.

Jintinkagtin inimui:

- Shimpi waagkujinish uchish wajupa
chimpimainaita.
- Wajupa uchish atsumnawa
awekastasaish.

- Kam uchi egkea awekastasaish wajupa
atsumaji japikti tusaish.
- Mina awekattsati tusanush wajupa
uchina atsumaja.

Waji ayamtainmash awa nunash juki
awekaumainai.

Tinamui papi takasti tusa.

Waji atsumnawa

Shimpi.

Kanu dakumkamunum dakumkata wajupa uchish egkeme nunu. Jakimtikata tuwi
uchish kuwashtash awa.





Daag:

Unuimagbau iwainmamau

Jintinkagtin ujamau

Jintinkagtin uchi aidaun anentaimtikawai wajina takasagmayi.

Kumpajijai augmattsagtatui wajina takasagmayi nuna.

Yamai ame dakumkata tita wajina wakejusash takasajiawa.



Three horizontal dashed lines for writing practice, located to the right of the girl's illustration.





**Awantua najantai
dekaami**



Bachig augmatbau

Bachigchik aa wajakui aents
kaamjaush, datsa dushigpatin,
ijastatus wakeyin asa, ijaju
wajakui Iwan awajunjai, aantsag
yacha shiigmaush wajakin,
wamak unuima wajakui. Iman
asa ujuchi awantua najanu:
itipak, karash, senta aidaun.
Aanstag kaap, yajag aidaujai
najanu chagkin, wampach, tikich
kuntin mautai aidaunash ashi
tinamas dekau.

Tsejek dekas unuimajui iwa
najanmaun wainak.

Bachig

Bachig augmatbau

Jintinkagtin ujamau

Jintinkagtin bachig dakumkamun inakmawai.

Iniiimui:

- Yaa iinianash ujushjai itipak, tarash najantanash jintintuauwaita.

Jintinkagtin uchin tinamui, takatain pag. 161 jintinkagtin yaigkam augmattsamun aujainawai. Aujus inagnak Bachig pegkeg jintinkagtuamun pachis ujainawai.

Uchin iniiawai:

- Yaki aayi Bachigkish.
- Awajunnash, Bachigkish wajinak jintintuauwaita.
- Bachig awantua najantain, awajunin jintintuachuitkuish wajukmainuk wajaji. Wajinmak egkeash jumainuk wajaji.

Bachig augmatbau

Bachigchik aa wajakui aents kaamjaush, datsa dushigpatin, ijastatus wakeyin asa, ijaju wajakui Iwan awajunjai, aantsag yacha shiigmaush wajakin, wamak unuima wajakui. Iman asa ujuchi awantua najanu: itipak, karash, senta aidaun. Aanstag kaap, yajag aidaujai najanu chagkin, wampach, tikich kuntin mautai aidaunash ashi tinamas dekau.

Tsejek dekas unuimajui iwa najanmaun wainak, nunik unuimag nii jintintuauwai awajun aidaun.

Tuwi takanua

Ayamtainum.

Dakumkata Bachig.



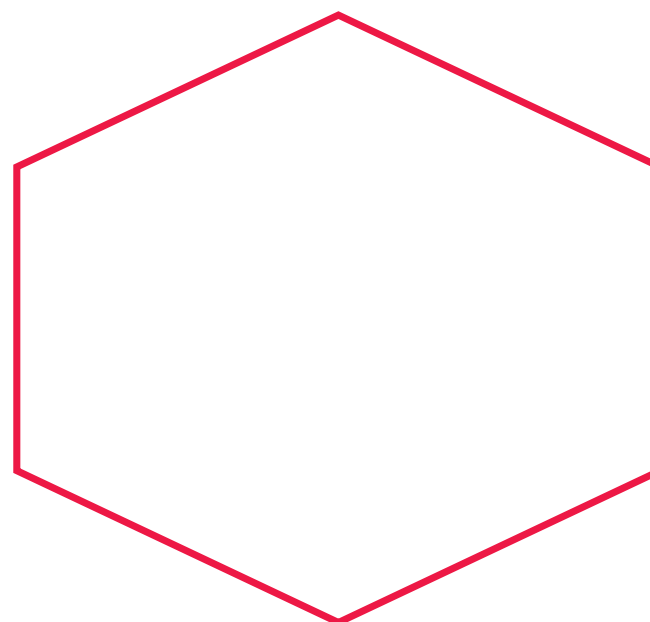
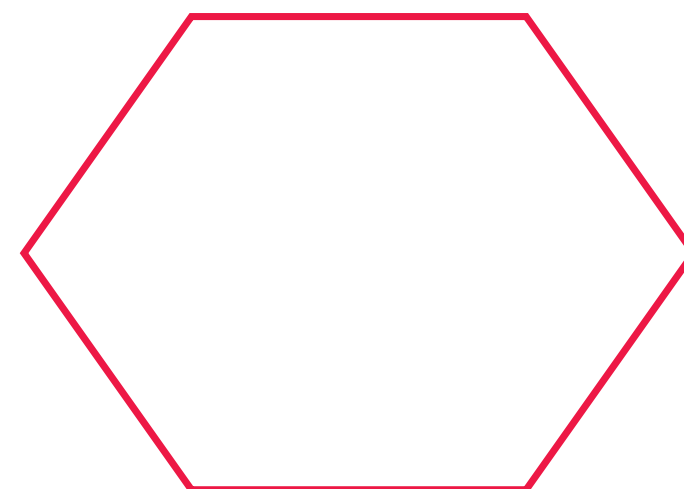
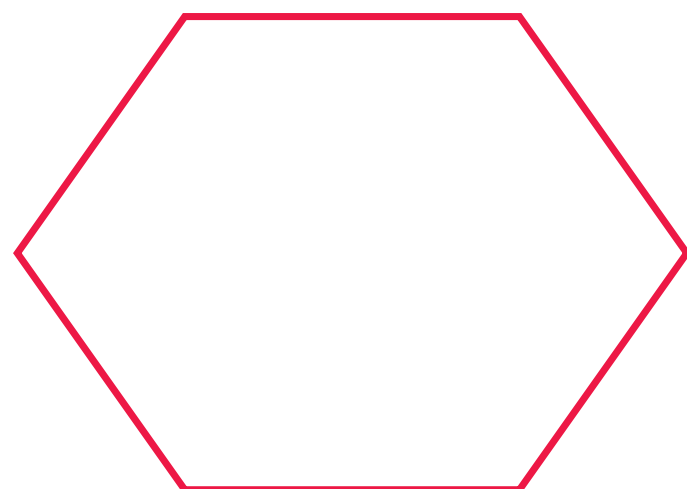
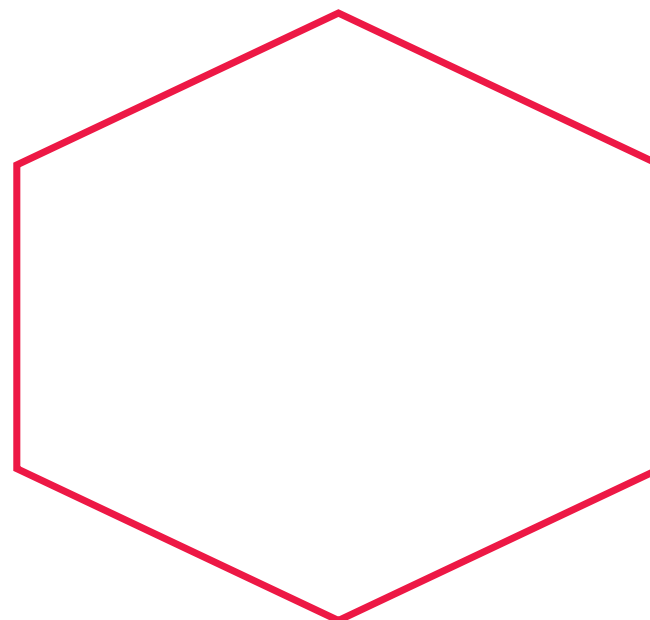

Daag:

Awantua najantai dekaami

Jintinkagtin ujamau

Jintinkagkin uchi yajuak ijajui, makichik muuntan dekas chagkin wampach najantan dekaun.

Apag uchin ujawai chagkin wampash najantaish tuwiyag jutaiyaita nuna. Aantsag dukug uchin ujawai chagkin wampash aidaush wajuk kuwitamtaita nuna.

Kaap,batae yajagjin uchin apatuk diistinme wajukukita achisa diyamash katsugmashit tusa inaktawai.

Uchi aidau diita dekaushmaujin iniimainawai.

Jintinkagtin ayamtainum taa uchin, tinamui kaap najanamun (chagkin, suku)nuwigtush yajagjai najankamun (wámpash).

Yajagjai najankamun akanag batsawai.

Jintinkagtin iniawai:

- Yajagjaish tikichish waji takamainaita.

Jintinkagtin uchijai diita aimkamujin jikatus diinawai nuniak tuinawai tujai awantua najantai aidaush katsujam pegkejash amainaita nuna.

Jintinkagtin tinamui takatain, aantsag dakumjamun pag. S4.

Yaa yaimainawa

Muun awantua najantan dekau.

Waji atsumnawa





Chagkin, suku, tukup, japimuk kaapi najanamu, japimuk batae kuwijjai najanamu, wampash yajagjai najanamu.

Waji yajagjai najantai ainawa nunu anujata.
Dakumkata yajagjai, tikish najanmain aidatsuak..

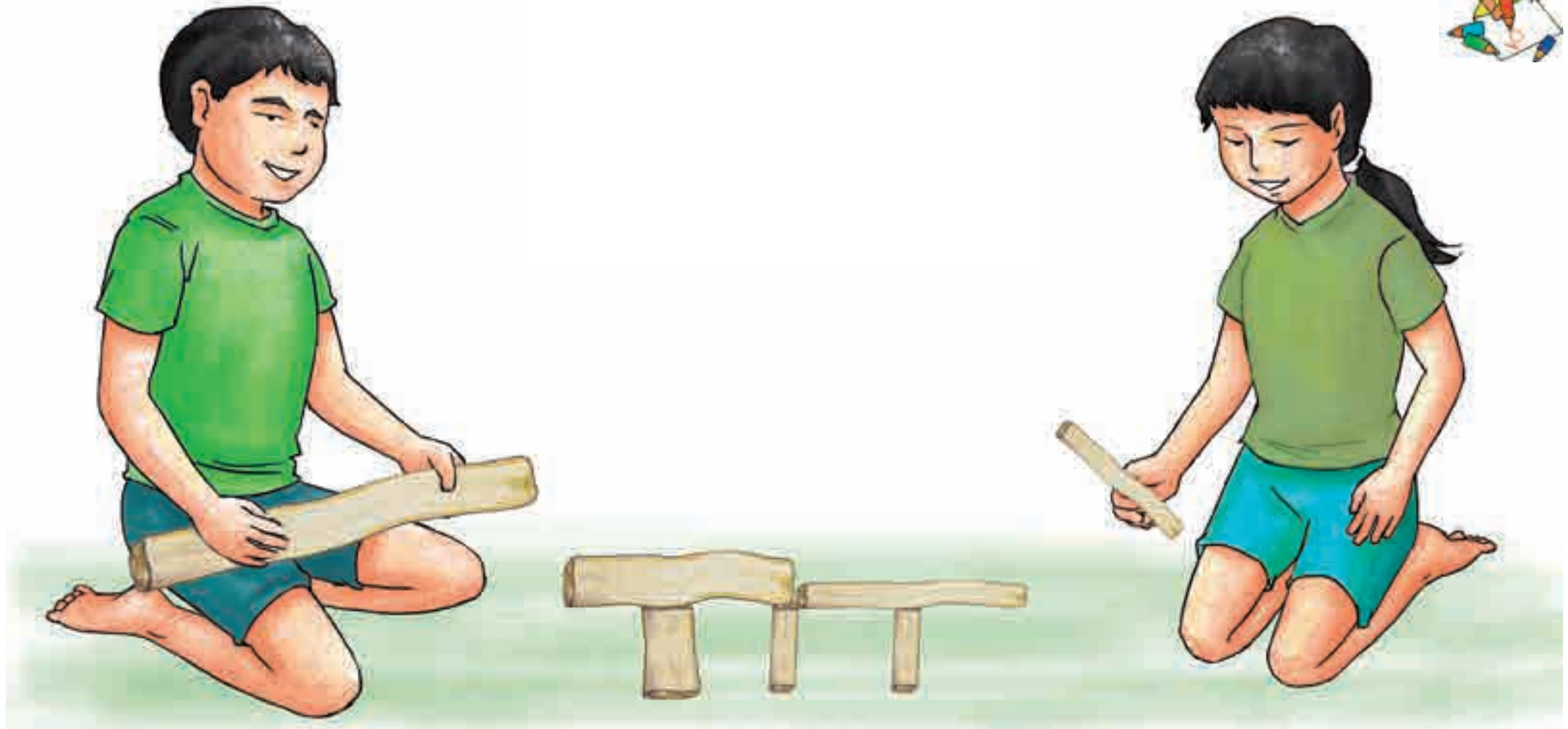

Three horizontal dashed lines for writing, positioned to the right of the girl's illustration.



Daag:

Kaapjai najantai dekaami

Jintinkagtin ujamau

Jintinkagtin uchin kaap esajam, sutag nuwigtu kampuham, tsejeg aidaun tinamui.

Kam kam juuniikag, kaapjai diita waji wakegamun najanainawai.

Wajina najanawaje nuna kumpag. inaktuinawai nuniak wajupa kaap tsupigmaun jukig najanawaje nuna dakapainawai.

Jintinkagtin papii takatai tinamui.

Tuwi takanua

Ayamtai.

Waji atsumnawa

Kaapkesh numikesh esajam, sutag, kampuham, tsejeg aidau maki makichik wej ejetuata.

Kumpagmijai juunikmesh dakumkamu diismesh waji najanamume nunu dakumkata. Dakapajam agagta wajupa kaapish jukimesh takasmume.



Three horizontal dashed lines for writing.

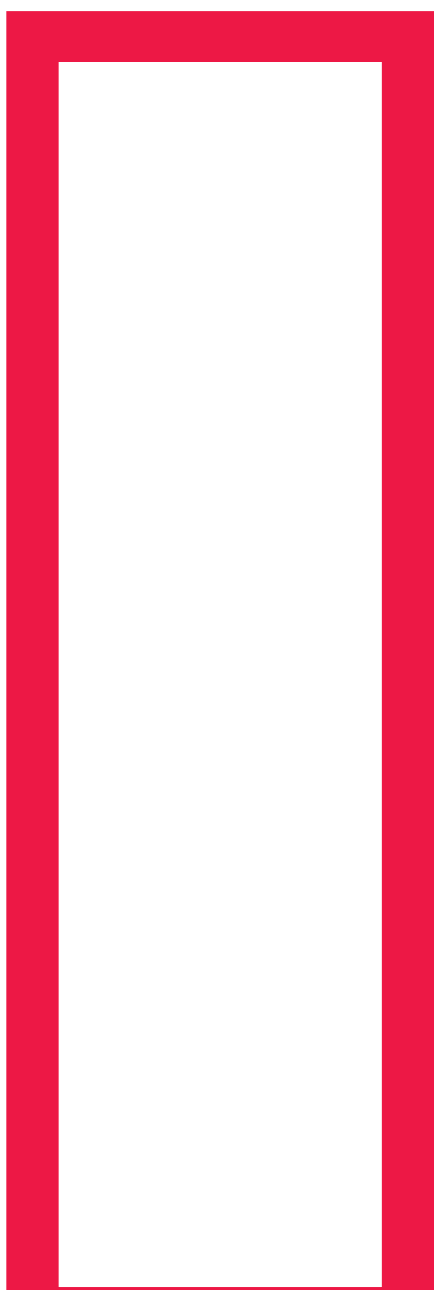
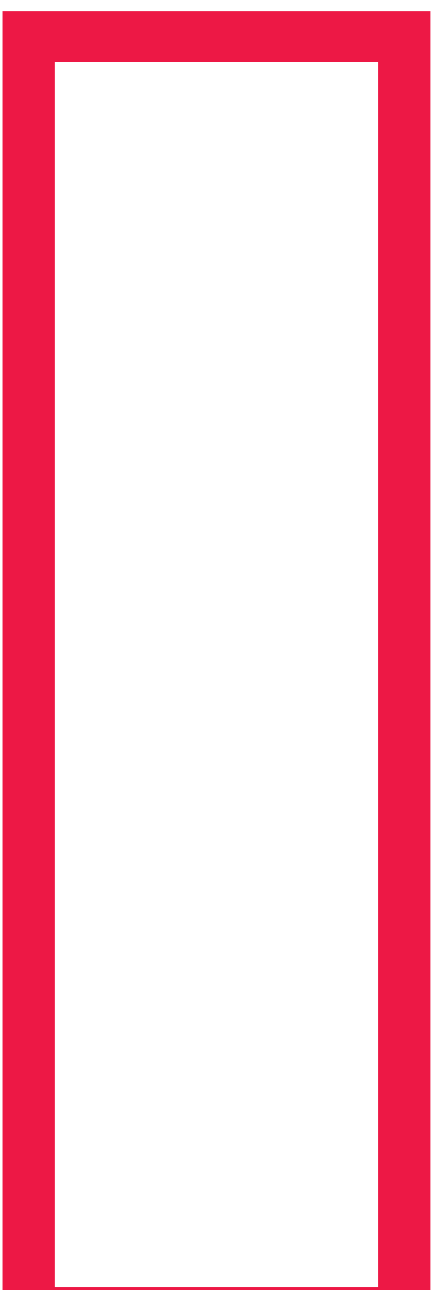
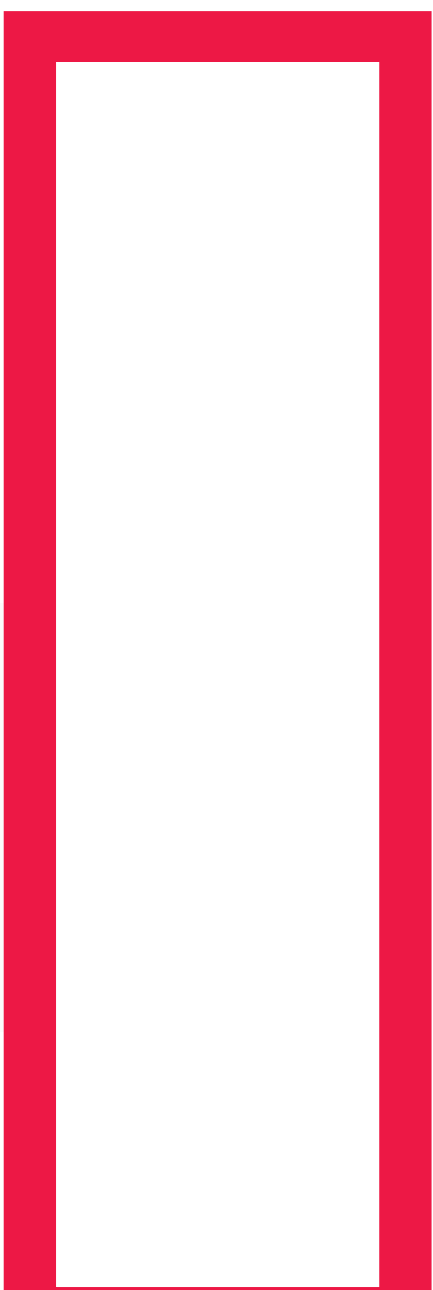

Chagkinash wajuk najantaiyainta

Jintinkagtin ujamau

Ii batsatkamujin pataa aidauk chagkin najantanak kajimatkiag wenawai tusa uchi aidaum ujawai.

Jintinkagtin iniiawai:

- Jeeminish chagkinnash najannuk aagma.
- Yaa chagkinnash najannuwe.
- Atumnash jintinjamnuk aagma.

Kajimatkiag tusa jintinkagtin uchijai wajuk chagkinash najantaiyainta nuna chichama umik agawai.

Muun chagkina najannu jeen ijainak weenawai.

Kaapi esanti, kampuji, chagkin awanmaunash shiig esetus diinawai.

Uchi chichagkagtamunash jikatus antuinawai.

Ayamtainnum kaunawag muun takamu unuimagbaun augmatuinawai.

Jintinkagtin uchi augmatmaun agawai.

Jintinkagtin uchi antuktinme shiijash agajag tusa aujai.

Uchin papii takatai tijigjai tinamui .

Yaa yaimainawa

Muun.

Tuwi takanua

Muunta jeen.

Dakumjamu diisam wajuk chagkinash najantaiyainta nunu aganta.





Daag:

Yujumak patasa yutai najanami

Jintinkagtin ujamau

Jinkinkagtin uchin ujawai dekas puna bikajai tusa patattsa ekeni yutai najanami tusa.

Uchi anentain apujainawai wajuk najanmainkita punanum ekeni yutai aidaush tusa.

Jintinkagtin uchin tinamaui takatain pag. 171. Uchi jintinkagtinjai aujuj wajuk juki awantuash najanawagtatua nuna pachis.

Inimui utujimaun.

Jintinkagtin suwawai achu duke tsupigmaun, dutikam yaigkam najanainawai.

Dakumjamu diisam patasa yutai najanata. Jintinkagtin yaimpakmatai.



Three horizontal dashed lines for writing.

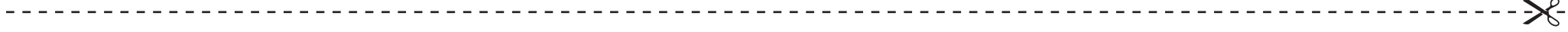
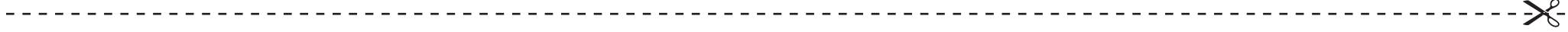
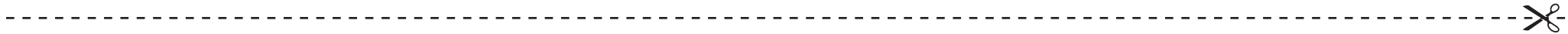

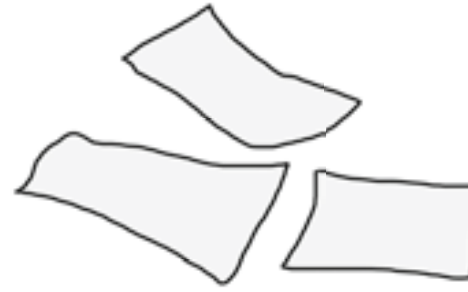

A large, empty rectangular area with a red border, intended for writing or drawing.

Daag:

Jakit najanat unuimagmi

Jintinkagtin ujamau

Jintinkagtin uchin yamakai duke, ipaku jigkayi aidaun inaktawai, antsag jaanch yamakajai jakimtijamu aidaun, pinig ipakjai agakmaun.

Uchin jujai jaanch jakimtiktaiya tusa ujawai.

Uchi iniiawai: utugtampaita duka aidau jaanchin jakimtijati tusaish.

Uchi diita anentaimaun chichainawai, jintinkagtin papinum agawai.

Wajuk diita aimkaje nunisag juunik takainawai.

Tuwi takanua

Ayamtainum.

Waji atsumnawa

Yumi, jaanch puju, jaanch chinchakjai jakimtijamu.

Yamakai dukesh utugkeakmea jakitjish jikmume nunu dakumkata.



Three horizontal dashed lines for writing.

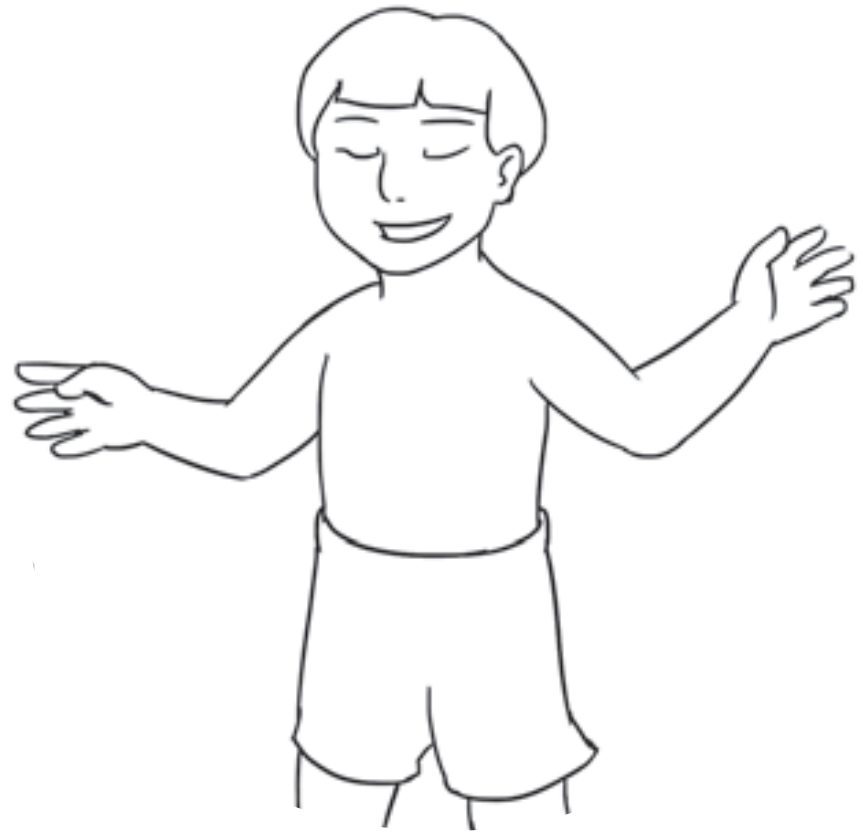

Daag:

Aishmag nuwajai nugkutai aidau

Jintinkagtin ujamau

Jintinkagtin nuwanun nuwigtu aishmagnun nugkutain aidau, iwaintawai.

Uchi aidau jaanchish wajukuk ainawa tusa achis diinawai.

Uchi nuwa nugkutai aishmagnaujai akanag batsawai.

Jintinkagtin jaanchish wajukuk ayi iniia nugku ajakmaush, yamaish wajukunak nugkuinawa nuna uchijai augmatuinawai.

Uchi nuwaush aidau tarachin nugkuinawai, aishmag aidau itipjuinawai.

Jintinkagtin papii takatain pag. T6 uchin tinamui.

Tuwi takanua

Ayamtainum.

Waji atsumnawa

Nugkutai aidau.

Aishmag dakumkamunum, anugkata niina takataiji aantsamek nuwanuchkam.



Three horizontal dashed lines for writing.



Daag:

Iwagmamtai najanbau

Jintinkagtin ujamau

Jintinkagtin jigkai waaji najatkamu aidaun uchin inaktawai.

Jintinkagtin iniimui:

- Waji wainjume.
- Jigkaijaish waji aikmainaita.
- Wagka jigkaish wegana.
- Yaki jigkai wegagmaunash nugkuwaita. Wajiyai aishmagkush iwagmamnush ayi.
- Wajiyai nuwash iwagmamnush ayi.
- Yaki nuwa iwagmamak nugkugtinash, kugkunash umignush ayi.

Jintinkagtin nuwak ditak jigkai ainaunak wegaja nugku ajakui tusa uchin ujawai.

Jintinkagtin yabaik jigkai atum wakegamu wegagtatjume tusa uchin ujawai.

Uchi aidau diita anentaimaun najanainawai.

Jintinkagtin kam kam uchin akanag ijumui, wegagmau wegantun tinamui, dutikam nii wakegamun etegkeawai, apatuk diyawai betekash aina tusa. Jintinkagtin takatain tinamui.

Waji atsumnawa

Jigkai waaji najatuamu aidau.

Dakumjata jigkai peetai patakumtaijai wegaja najamujum.



Three horizontal dashed lines for writing.

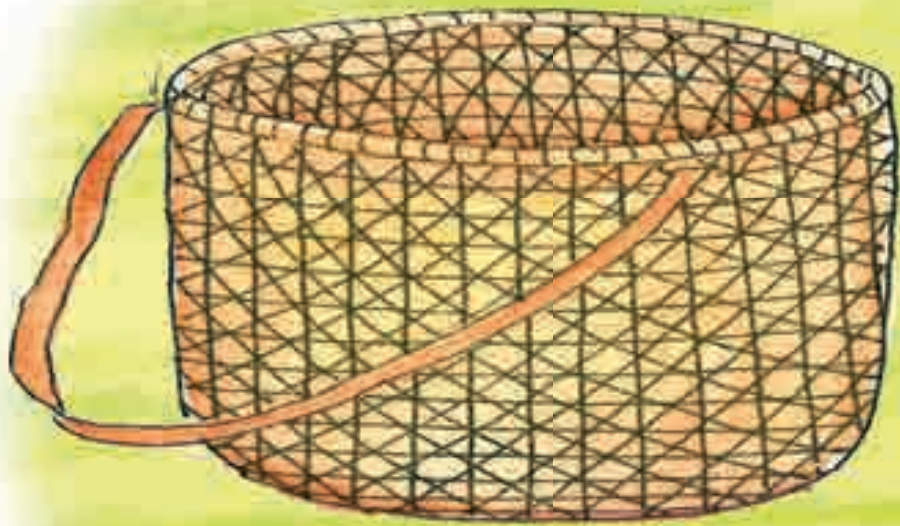

Daag:

Chimpiamu wasugkamami

Jintinkagtin ujamau

Uchi aidaujai paampa kaunkajijai tewa najankata dutikam aga batsasta.

Sup uchi ijumjam maki makichik tewa tinamkata, aga chagkin apusamunum makishkia nagkima chagkinum egkeatnume.

Dekatkau wajau papinum wajupa kumpajish nagkimash egkeatig nuna agagtatui.

Wasugkama nagkanmaunum jintinkagtin iniimui:

- Yaa chagkinnumash ima kuwashtash egkeae.
- Wagka ima kuwashat egkeae taji.
- Utugkeakjia aan kuwashat emamainitji.

Papii takatain tinamui.

Tuwi takanua
Ayamtai agajin.

Waji atsumnawa
Chagkin, tewa.

Chagkinumash wajupa tewana egkeawaje nu diisam agagta.



Three horizontal dashed lines for writing.



Daag:

Unuimagbau iwainmamau

Jintinkagtin ujamau

Jintinkagtin uchi aidaun anentaimtikawai wajina takasagmayi.

Kumpajijai augmattsagtatui wajina takasagmayi nuna.

Yamai ame dakumkata tita wajina wakejusash takasajiawa.





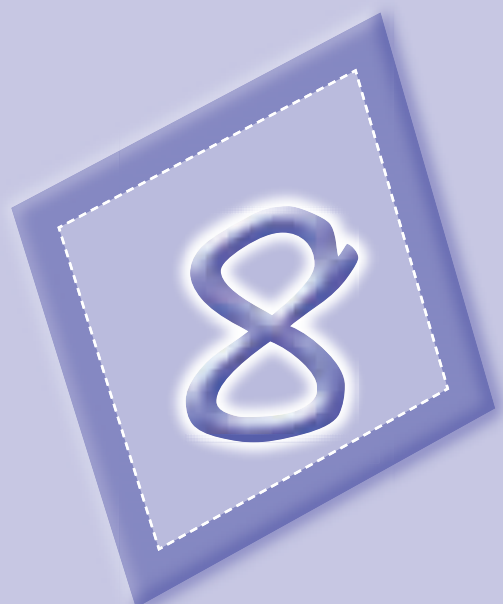

lina jee pachisa
unuimagmi



Daag:

Iina jeesh wajukuita

Jintinkagtin ujamau

Jintinkagtin tinamui takatai pag. 185 uchi jeen dakumkatnume tusa.

Maki makichik uchi jeen dakumkamun augmatuinawai.

Uchi diita takasbaun etsejuinak juna tuinawai:

- Wajiyai tanishmagmauwaita, aantsag waji dukai jegamkamuita nuna pachis.

- Etsejuinawai wajuk yujumak inagtaish awa nuna.
- Yaa ainuwa batsatua jeenish.

Jeega aidaun diinawai apatuk tuwi yapag.ua, aantsag tuwi betekmamtinaita nuna.

Jintinkagtin inimui: jeenmash wagka wakejusash diyawa, wagka.

Uchi dekamujin etsejui.

Jeemin yajai batsamnume nunu dakumkata.



Three horizontal dashed lines for writing.



1

2

3

4

Daag:

Jegash wajuk jegamtaiyainta

Jintinkagtin ujamau

Jegash wajuk jegamtaiyainta, jeganash yaa jegamua.

Jega jegamaun wainkamujin augmatuinawai.

Muun jega jegamaun uchijai shiyakag ijajuinawai.

Jeentin jega jegamku takatain iwainak ujawai wajinum atsumtai ainawa nuna pachis, aantsag ujawai wajuk jegamtainta nuna, nuwigtu tawai muun chichagkagtak aajam takasum pujustajum tiuwai nuu uwaemaisui tusa.

Uchi inimainawai nii anentaimas wakegamun, wajuk jegash jegamainkita nuna pachis.

Jintinkagtin, uchijai augtainum kaunawag muun chichau antukmaun patas augmatuinawai. Takatain uchin tinamui, dakumjamun.

Uchi iniamu:

Wajukmainaita muun jega jegamta dekachu, dekaun ipashkush, jintinkagtin jikatus antawai uchi chichagtai, nuniak ujawai, tuke muun ipatia, minag aidaush tuu ainawa, jega jegamtaish, antsag wajuk nagkama jegamtaita nuna ujatkatu tusa.

Tinamui papii takastinun, dakumjamun diisa umikti tusa.

Takatjin takasbaujin ashimak augmatuinawai.

Muun jega jegamu jintinjabauwa nuna dakumkamu jakimtijata.



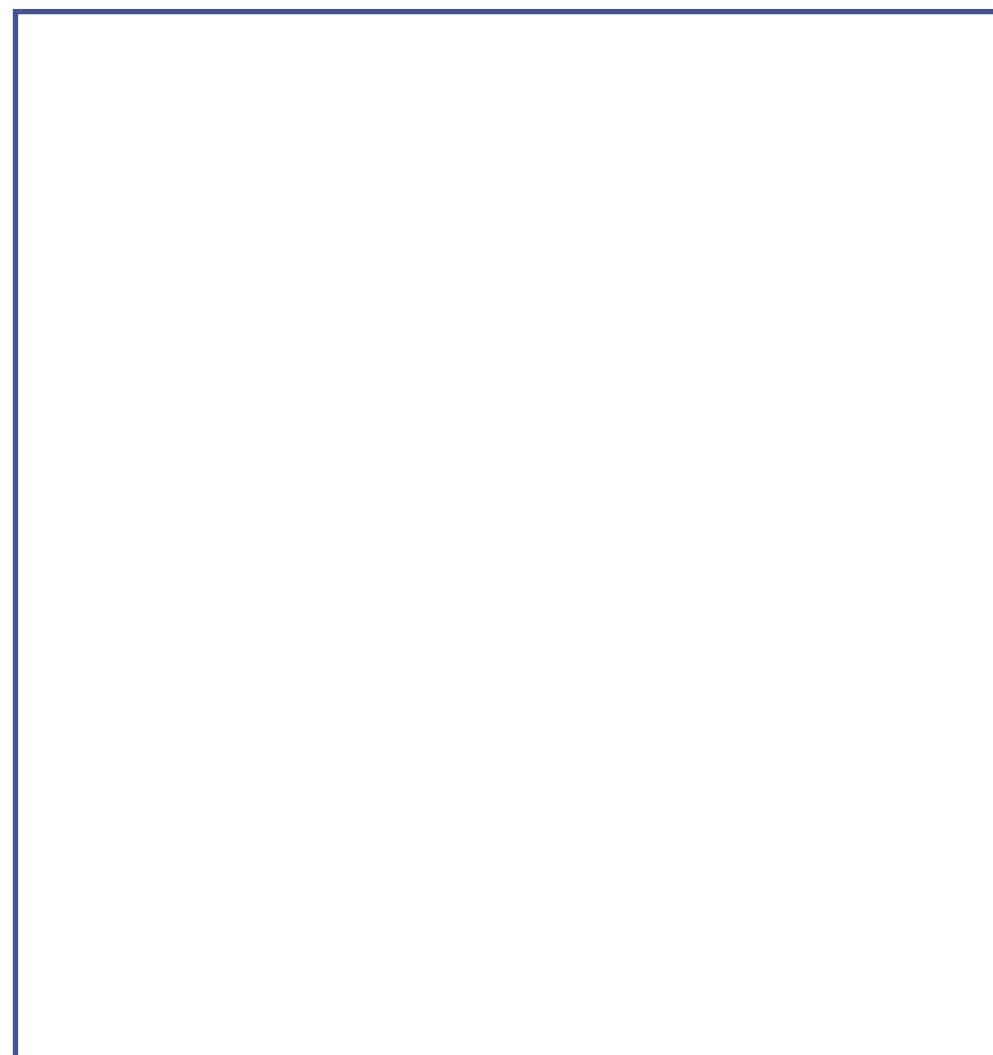

Daag:

Muun jeegamtan yacha tukee diigmaku amainai

Jintinkagtin ujamau

Jintinkagtin uchijai patas anenawai diita patayi jeega jeegamau wainkamun.

Jintinkagtin uchijai chichainawai jeega jeegamin ipam yaijatmainun, nugka, numi, duka aidau eteja jeegamtan.

Jintinkagtin uchin iniiawai.

Wajukmainkita jeentin numi shiig etegtsuk jegamkamash.

Jintinkagtin, uchi tuinamun antawai, nunik uchijai chichainawai dekas tuke ipamainai muun yacha jeega jeegamtan dekau tusa.

Uchin tinamui takatain.

Takas ashimkamtai segawai, takatjin iwainak augmattsati tusa.

Dakumkam jakimtijata atum wainkabaujum.



Three horizontal dashed lines for writing.



Juti batsatkamunmash wajuku jeega jeegamjamu ainawa

Jintinkagtin ujamau

Jintinkagtin uchin ujawai ii batsatkamunum wegaja diismi wajuk jeegash jeegamjamu ainawa.

Jintinkagtin nuna diinak yujas uchin juna iniawai:

- Wajuku ainawa jegash.
- Jeegash wajiyai tsentsankagmauwaita, nunikash waji dukai jegamkamuita.

Tanish wegantush jakimtijamuk aina, jeeganmash wajupa tsapui nimtaish ajawa.

Uchi waketug kauna nii jeega wainkamujin dakumainawai, ashi umik, wajaki kumpag. ujawai wagkag dakumkae nuna pachis.

Uchi dakumjamun nugka batsasag betekmamtin aidaun etegkenawai.

Jintinkagtin uchin iniawai: wajupa etejagmesh ijumjaugme, yanau ima kuwashat awa, yanau ima ujumak awa.

Tinamui papii takastinun.

Agagta wajupa jeega nish nimntin aidaush awa amina nugkeminish.





Juan Qantu Jee

Muun Juan Qantu pujawai
yakat Huancavelica,
nuwig senchi tsetsekai,
tuja jegak nugkai kuweja
jegamkamui, yumi
yutak wayawai tusa jee
dukugkamui chijishi
kagaku ainawai,
aantsag makichik waiti
aputusmauwai, tsapui
niimtai najatkamui.

Uchuchiji tsetsek wayawai
tusa, ashi umik juga esajin
jimag torito najanamun
aputuinawai, nunak
aikainawai pujut pegkeg,
dukap pujamu ati tusa.



Daag:

Tikich nugkanmaya jeega aidau

Jintinkagtin ujamau

Takastinun tinamui.

Jintinkagtin shiig aneas, juu dakumkamu jitusjuum diistajum nunikjum augmattsatajum tawai.

Jintinkagtin takatain aujui, uchi wajuk takasagtatua nuna pachis.

Uchi chichagtai shiig puyatjus antujuk dekas uchin iniiawai.

- Juu jegash,iina jeejaish betekmamtinuk aina.
- Wajjinia betekmamtinchauwaita.

Jintinkagtin, uchi tamaun agas juki, ujawai jeegak jeegamtaiya wajuku nugka ainawa nunu diisa tusa.

Juju agagbau jintinkagtinjai ijunjajum ausatajum.



Three horizontal dashed lines for writing.



Daag:

Iina jeenish wajuk yaimji

Jintinkagtin ujamau

Uchi aidaun iwaintawai jeega pujusan takatai aidaun.

Uchi aidau dakumkamu diisag etsejainawai, wajina takainawa nuna.

Jintinkagtin iniiawai:

- Amina jeeminish wajuknume, waji takaume.
- Tuu anentaimnume jeemin yaimkumesh.
- Tuu takata shijash awatamnuwe jeeminish.
- Tuu takata shijash awagtamchauwe.
- Uchi aidaush diitash jeenig yaimain ainawai.

Jintinkagtin uchijai chichainawai jeen diita takamu aidaun pachis.

Jintinkagtin uchin ujawai, takakjumesh

wainkam atum aikmainchauk takasaigpajum tsakaja wegakjum unuimagtatjume tawai.

Jintinkagtin, uchin tinamui takatain.

Dakumkamunum uchi takainaun wainkag, chichas etsejainawai.

Jintinkagtin inimui amina jeeminish amesh tuu takaume tusa.

Ipak uwegmin antigkam usuata ame jeemin takataigmejai paan betekmamtin diyamu.



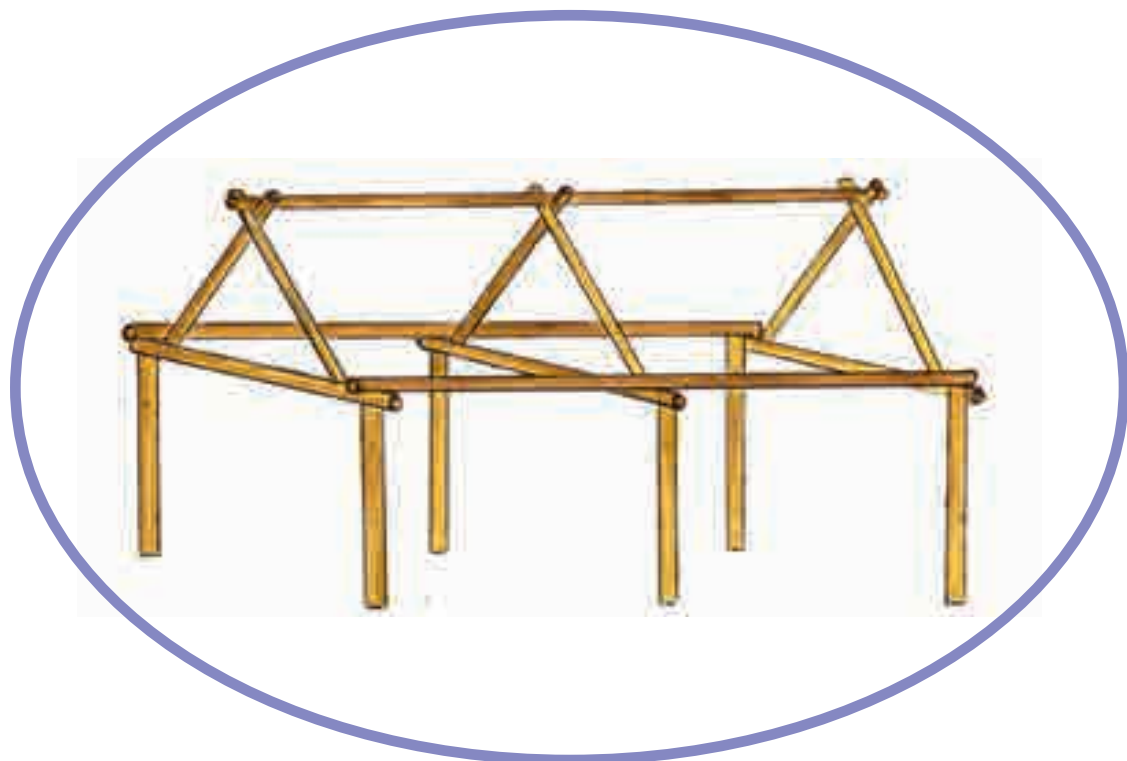

Daag:

Jeega uchuchiji iina augtaijin jeegamkami

Jintinkagtin ujamau

Jintinkagtin uchi ijumag ujawai, nuniak jeega jeegamkami yaijush iina augtaijin tawai.

Agag uminawai waji atsumnattawa jeega jegamunmash.

Uchi aidaun wajuku jeegash atatua nuna chichainawe, umiktinjai.

Juunik kanag ijumdaegag takatan akanainawai:

- Yaa numi itattawa.
- Nugka taitnun.
- Kaap itatnun.
- Dukan ikaunmatin aidaun.
- Yaa jeganash jegamkattawa.
- Duka sukagtustin ainaun ashi uminainawai.

Juu takatak kuwashtaush tsawantan atawai, tujash nagkanku diistatji wajuk nagkama umukji nunu pachisa.

Takataig nagkanku uchi tinamkattaji.

Dakumkatajum atum jeega jeegamkamu.



Three horizontal dashed lines for writing, positioned to the right of the girl's illustration.



Daag:

Unuimagbau iwainmamau

Jintinkagtin ujamau

Jintinkagtin uchi aidaun anentaimtikawai wajina takasagmayi.

Kumpajijai augmattsagtatui wajina takasagmayi nuna.

Yamai ame dakumkata tita wajina wakejusash takasajiawa.



Three horizontal dashed lines for handwriting practice, positioned to the right of the girl's illustration.

Ii chicham
umiktin
shiig aneasa
pujustasa





Yujumka yutsug ikigmajai

Tsawan 1	Tsawan 2	Tsawan 3	Tsawan 4	Tsawan 5

Jakigta tesamu ame uwejum dijaju asam.





Mina takataijun tsuwamja ukuajai

Tsawan 1	Tsawan 2	Tsawan 3	Tsawan 4	Tsawan 5

Tsawan 1	Tsawan 2	Tsawan 3	Tsawan 4	Tsawan 5

Daag:

Etsa dakumjamu anujata waji aidau ayamtainum tsuamaja ukuamu tsawantai yaimkau akumek.



Three horizontal dashed lines for writing, positioned to the right of the girl's illustration.



Wasugkamtainnak tsagkatdainujai

Tsawan 1	Tsawan 2	Tsawan 3	Tsawan 4	Tsawan 5

Daag:

Dakumkata yapi dushiau, tsawantai wasugkamtai tsagkatdaikau asam.





Ajantusan dinujai mina kumpag aidaunak

Tsawan 1	Tsawan 2	Tsawan 3	Tsawan 4	Tsawan 5

Jakigta tesamu tsawantin kumpajum ajantusam diisu asam.



Augmatjai pujutjun



Daag:



mijan ajutui - awajunitjai

Mina patag aidau

Juwai mina dukujuk



Juka mina apajui

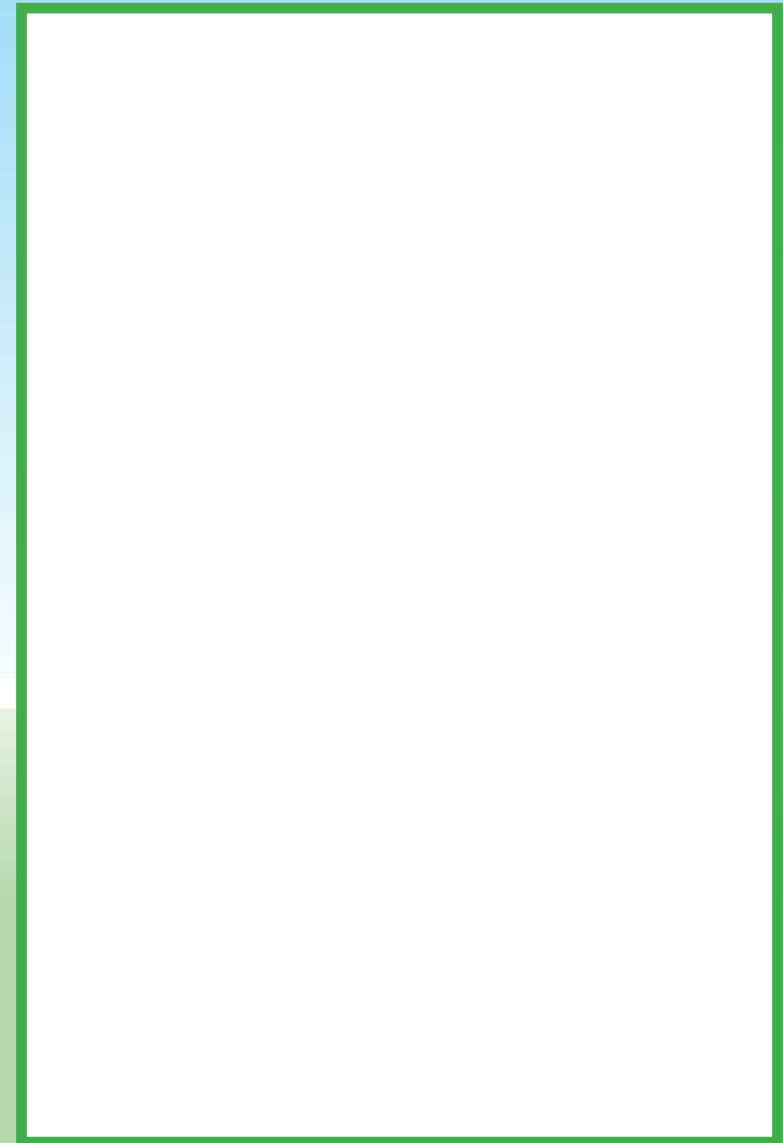

Dukuju daaji

Apaju daaji

Mina ubag aidauk jujuwai



Shiig
awatinuwe
minak yutak

Yutak shiig
awatuchuwe

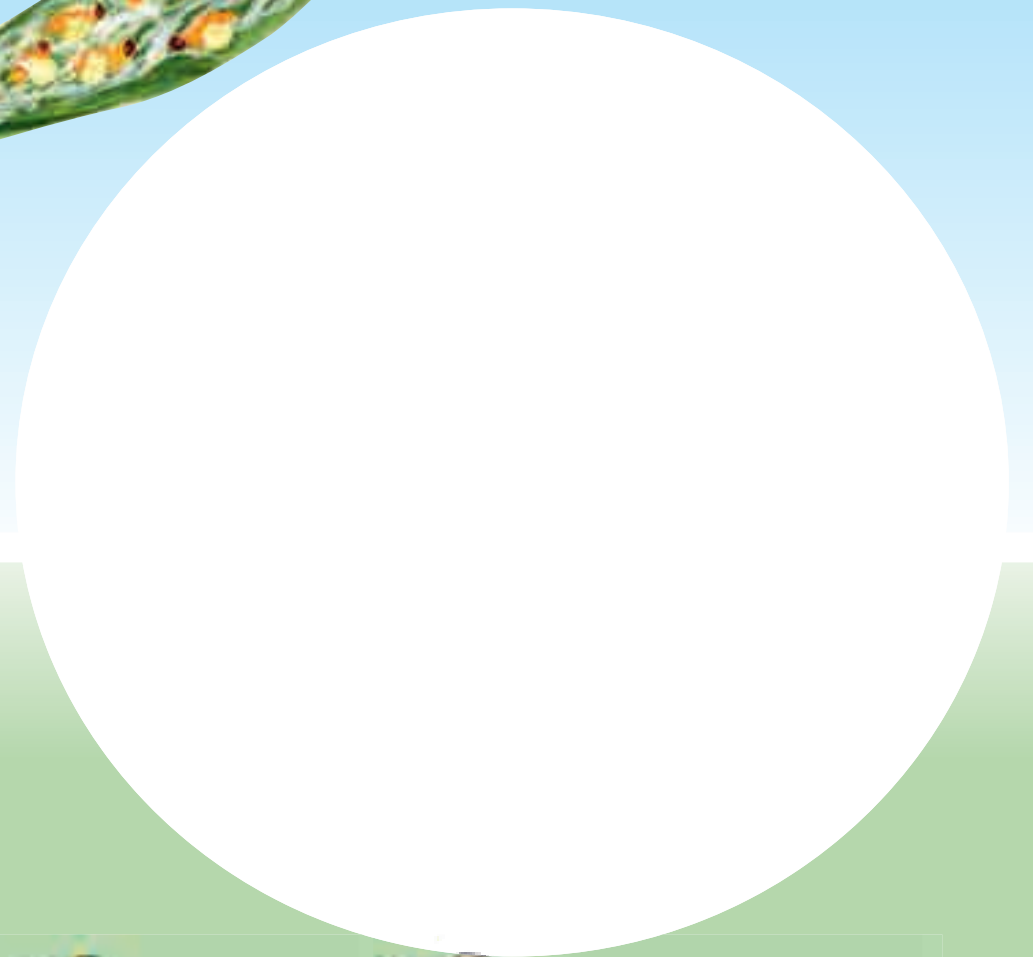
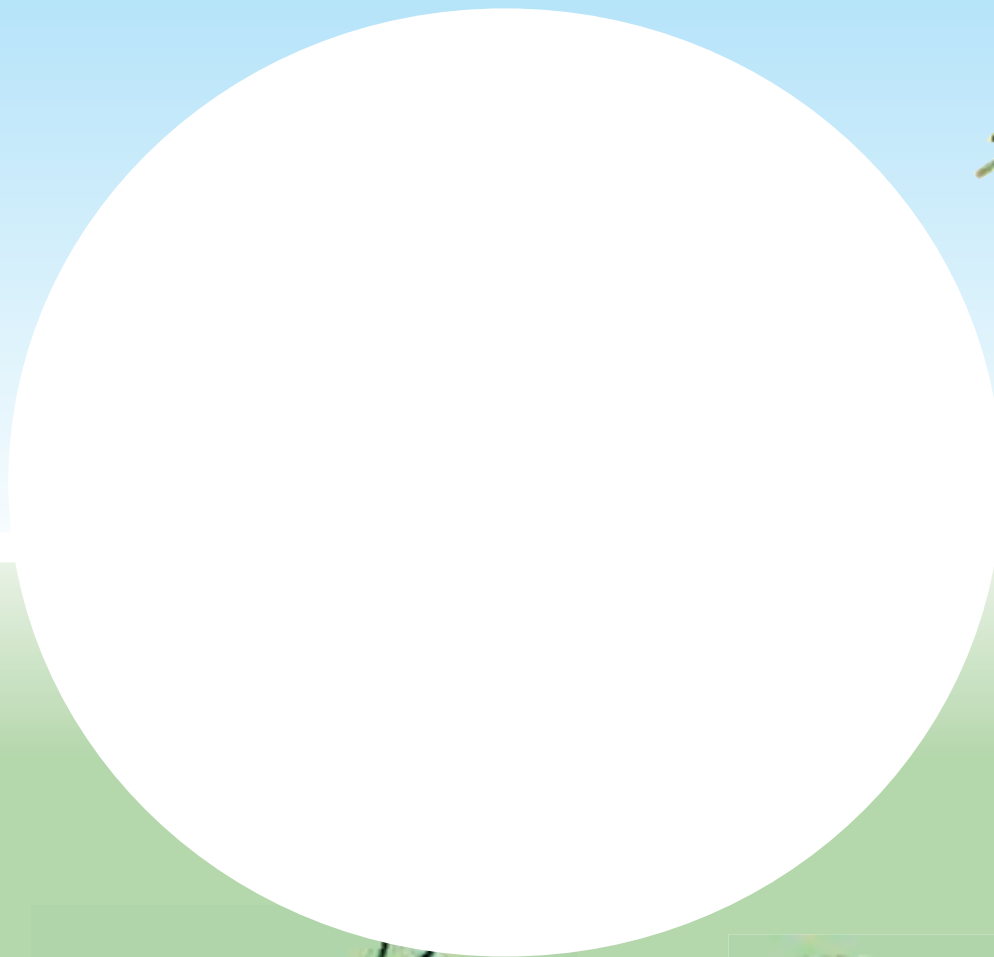

Shiig aneasa
pujajai

Wake besemag
pujajai

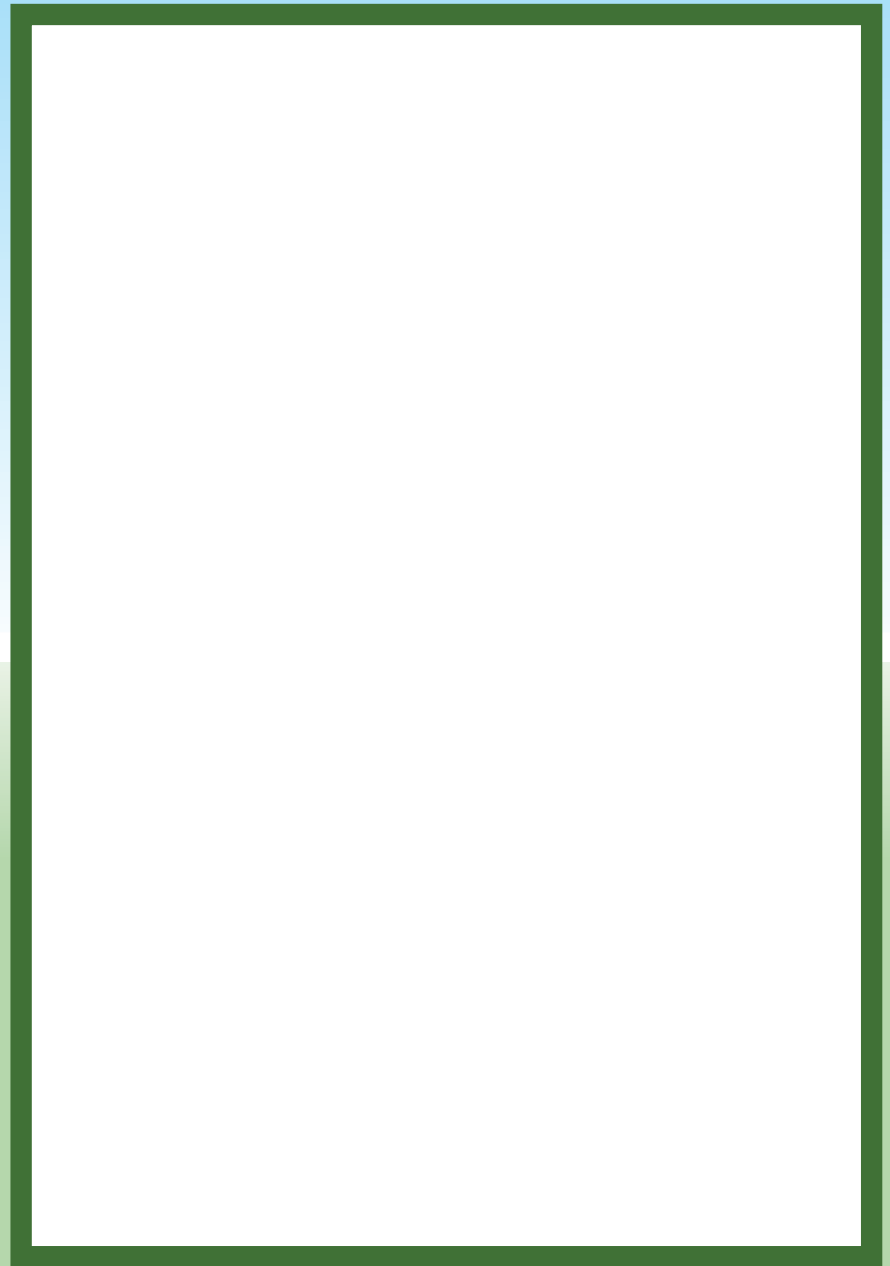
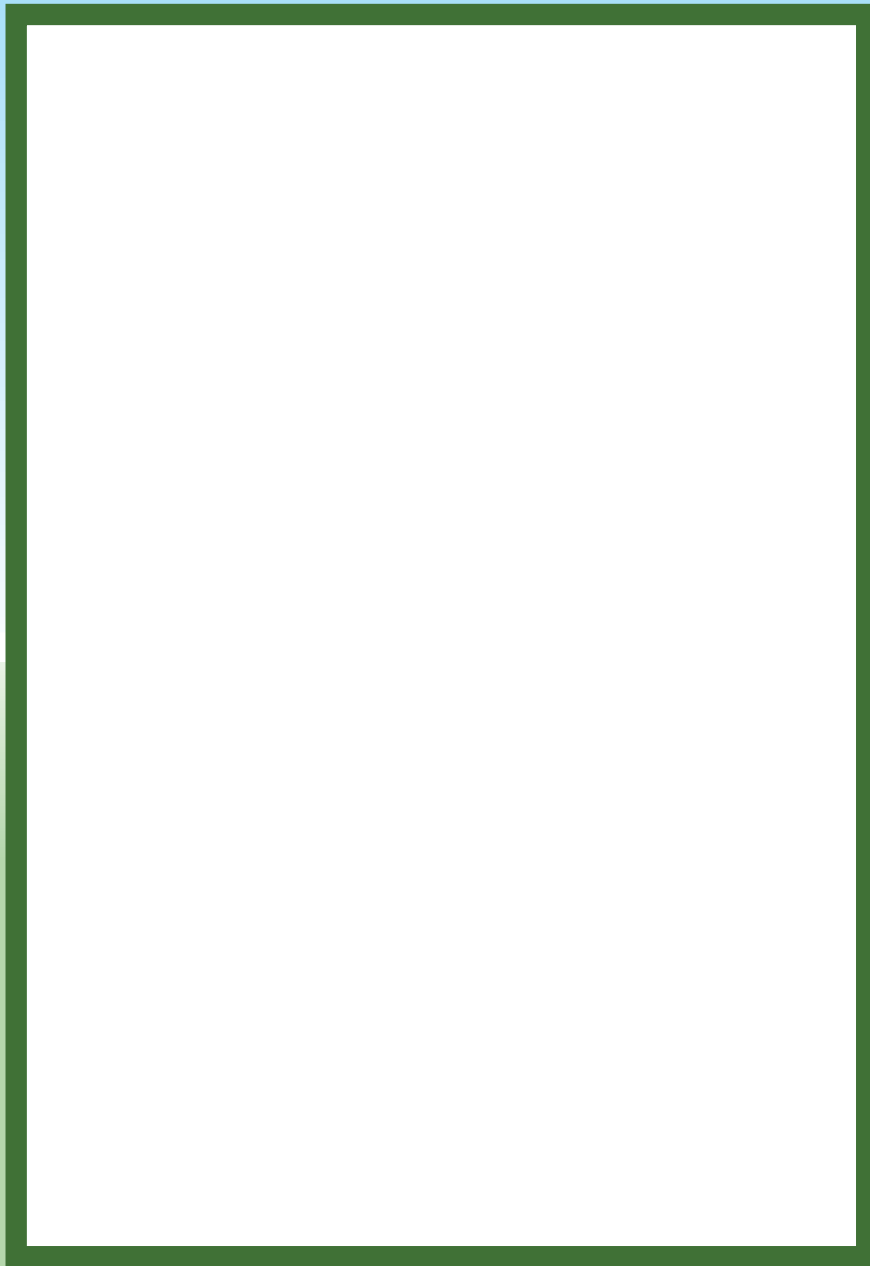

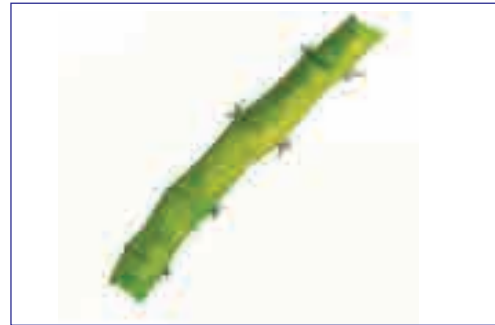

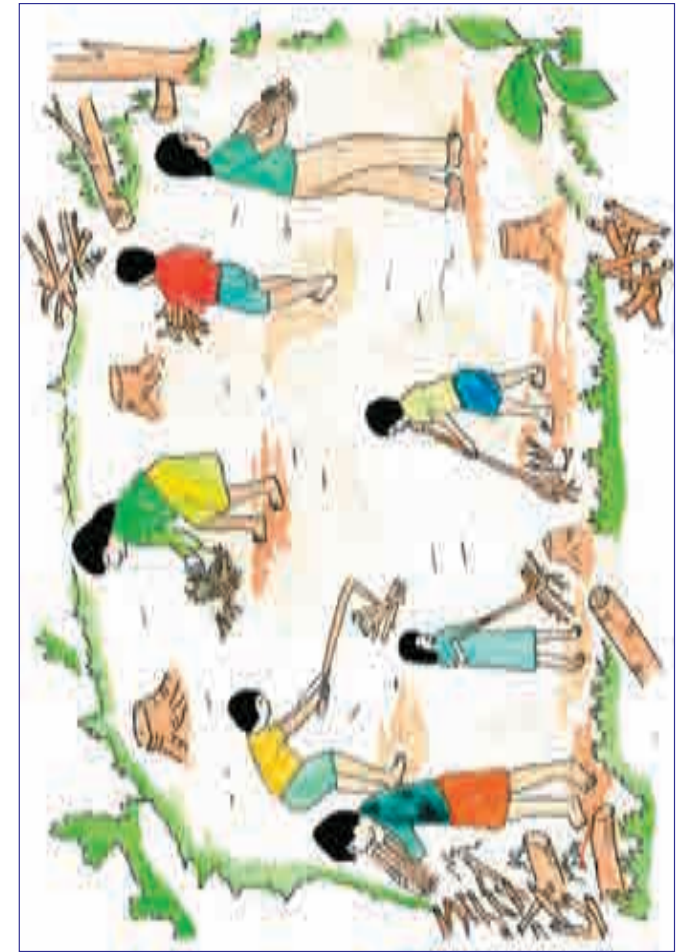

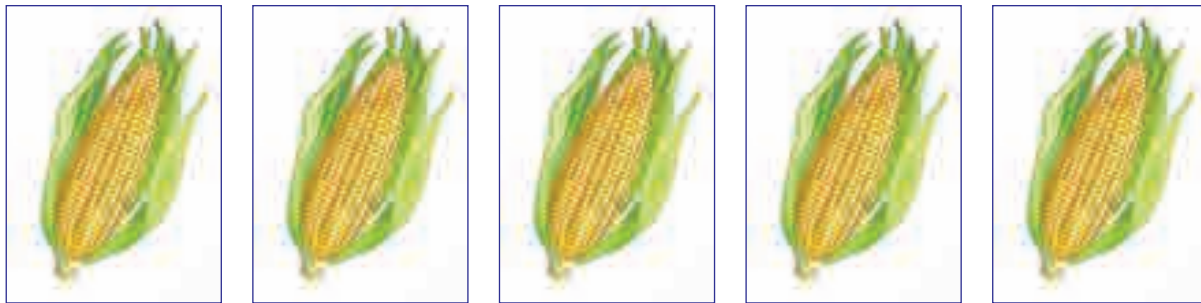

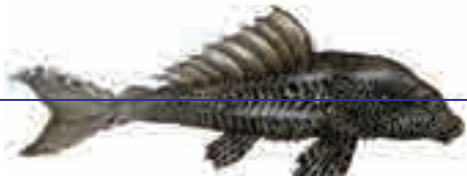

kanka



tunke



kamit

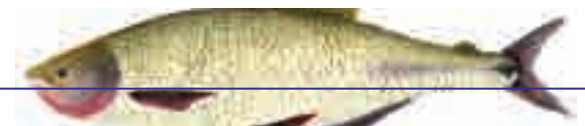

kusea



putu



pani

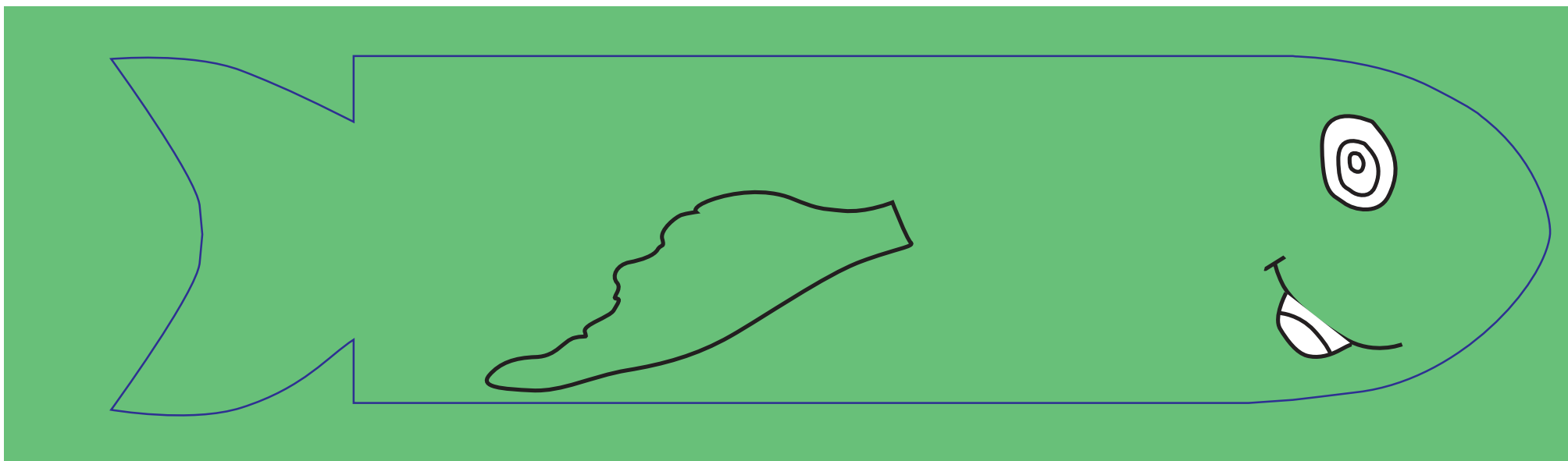
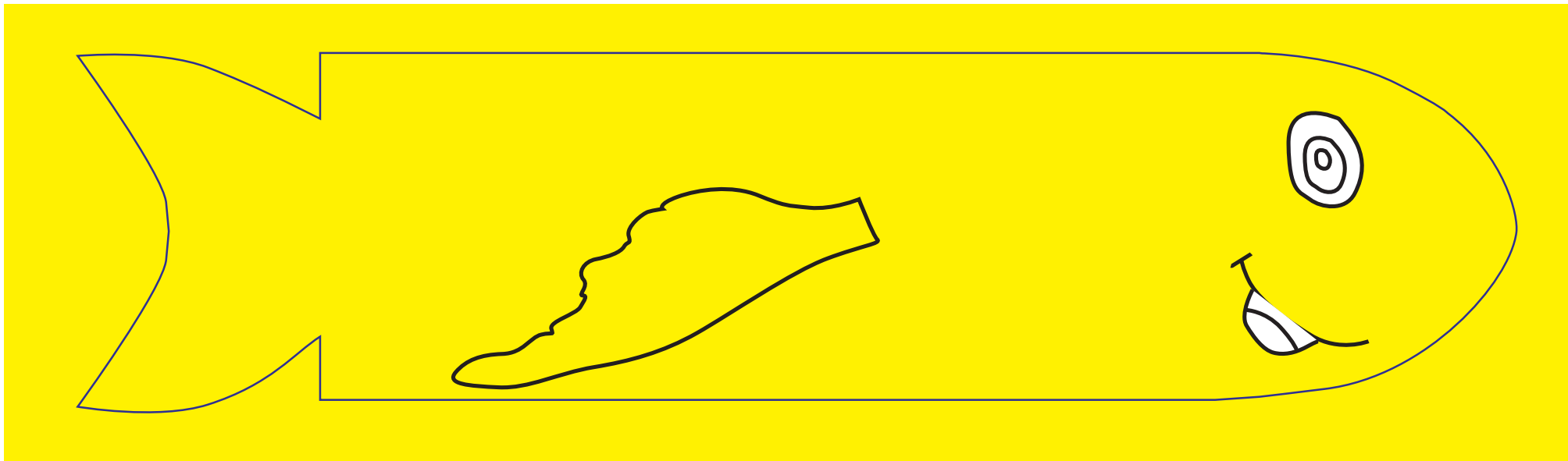

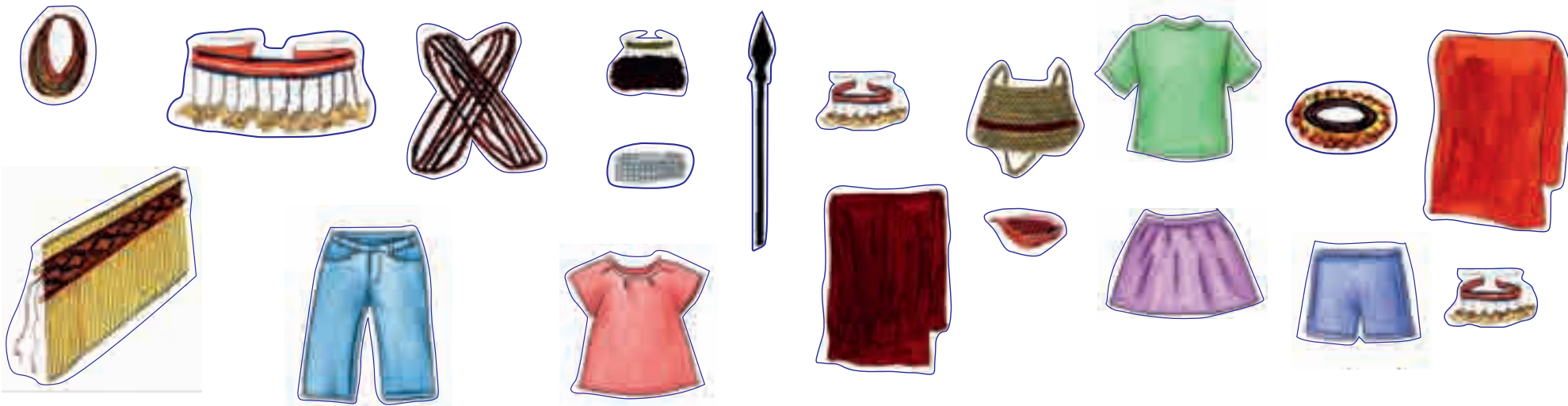

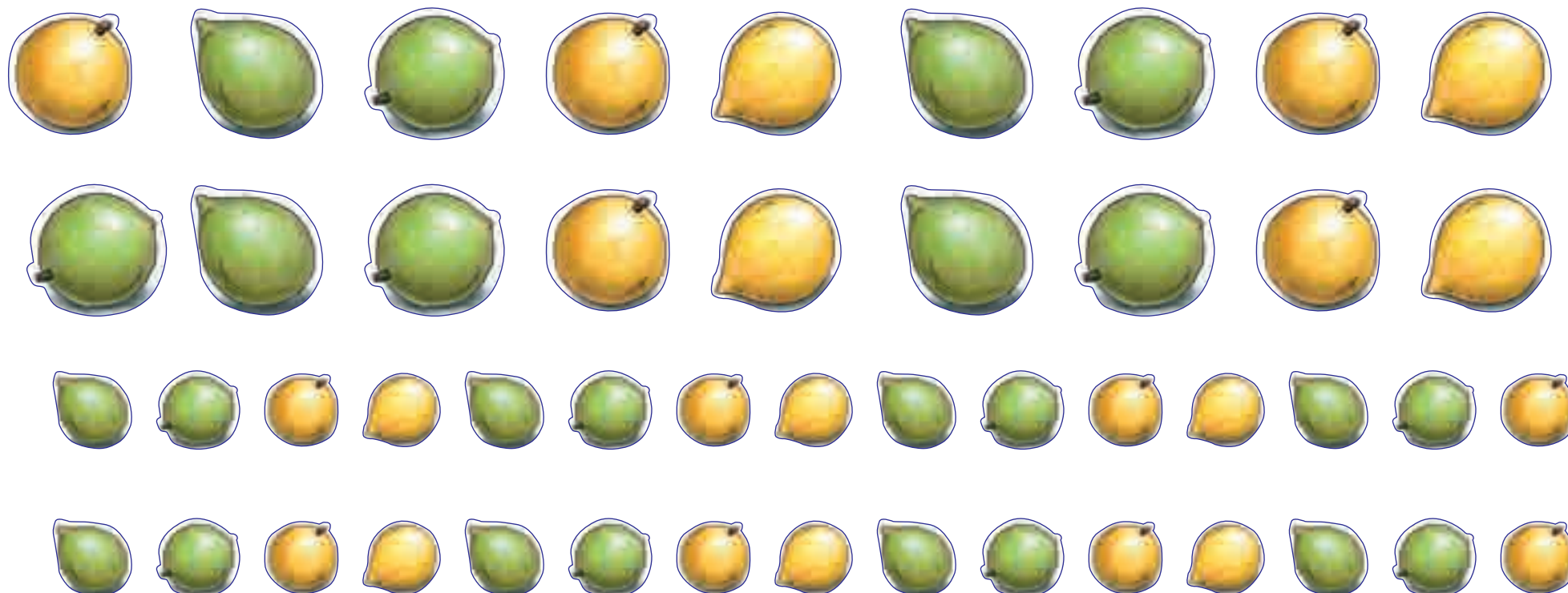
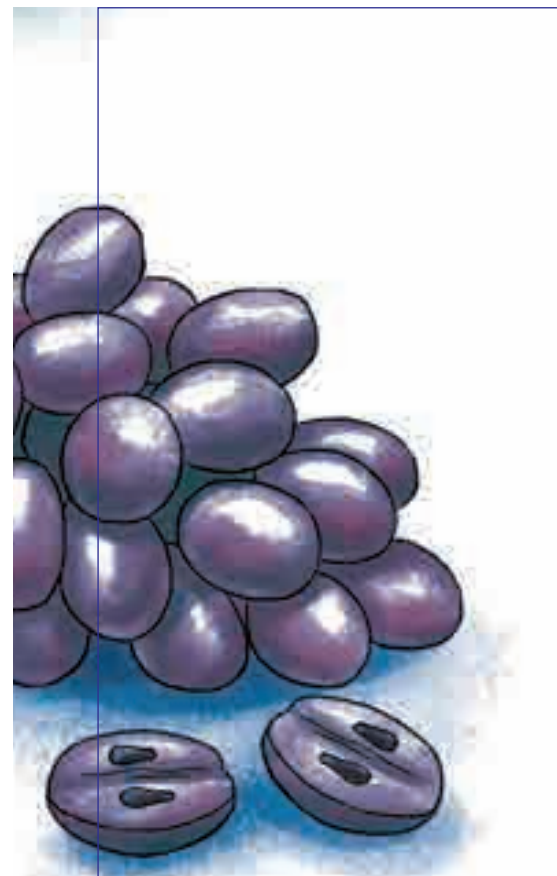
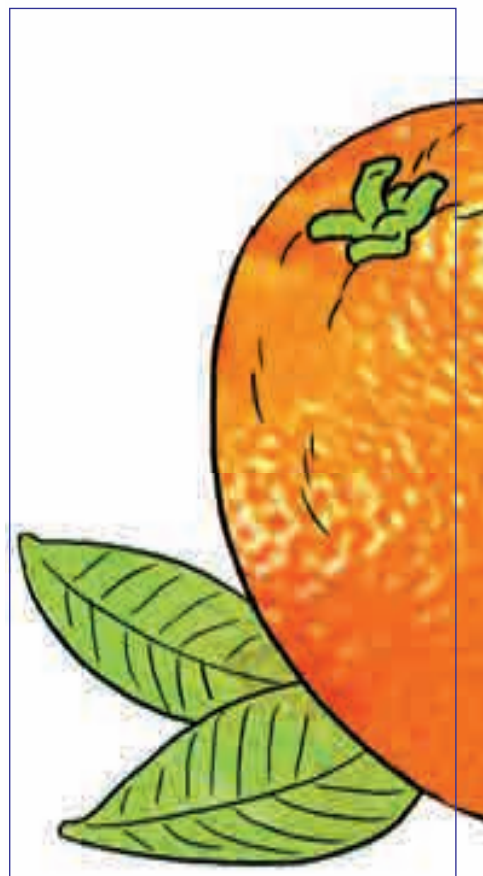





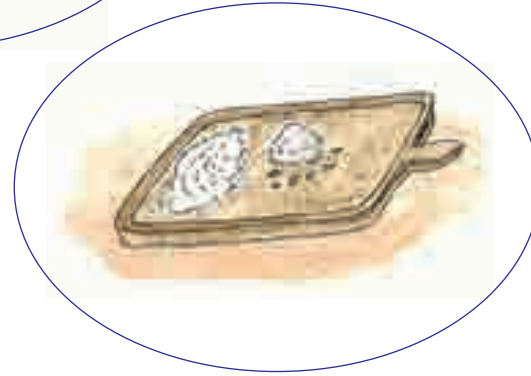



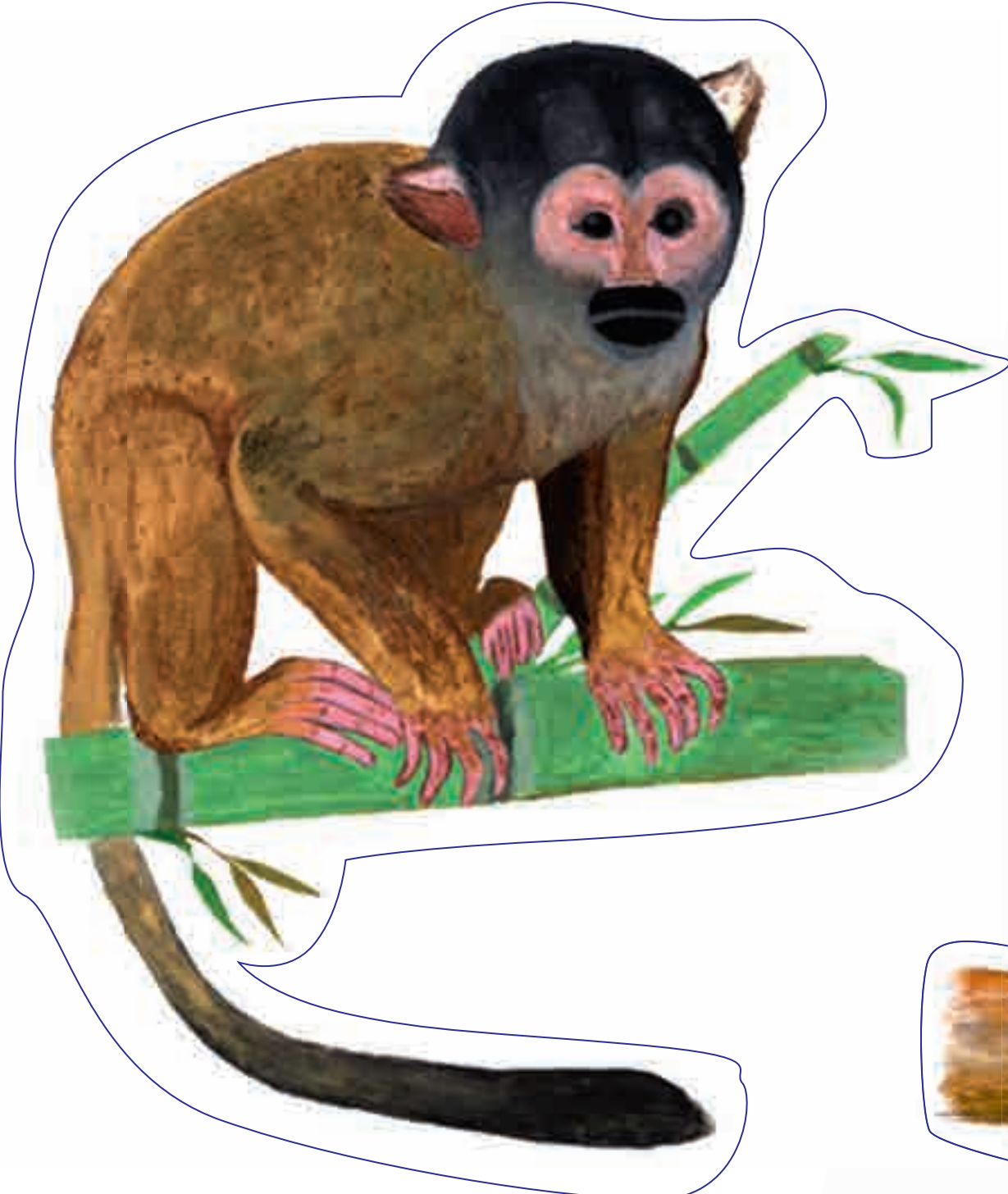



A large brown rectangular area containing a grid of 15 blue-outlined shapes for labeling. The shapes are arranged in three columns and five rows. The first and third columns contain irregular, wavy shapes, while the second column contains simple rounded rectangles.

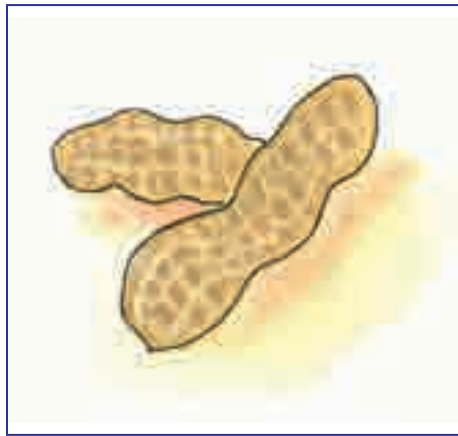
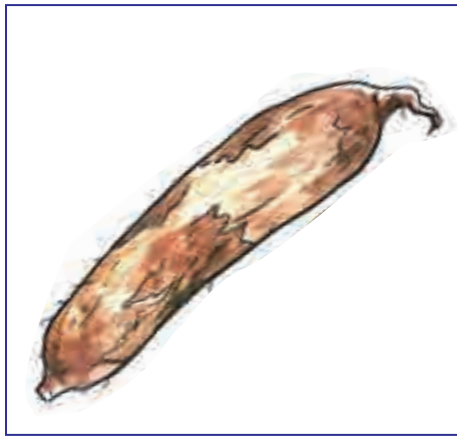
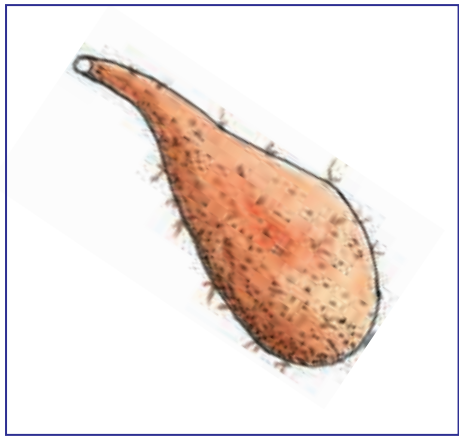
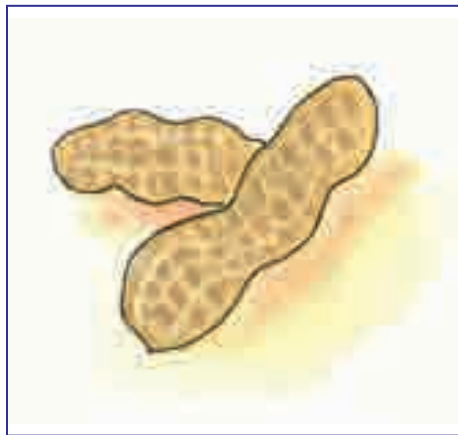
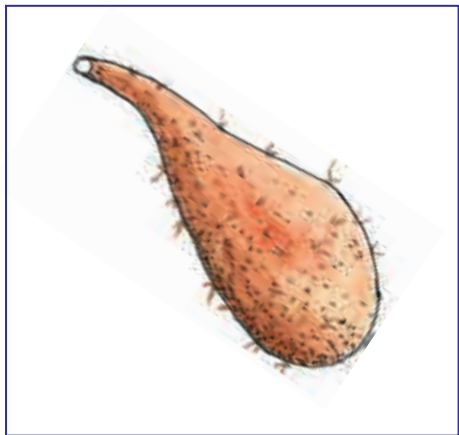

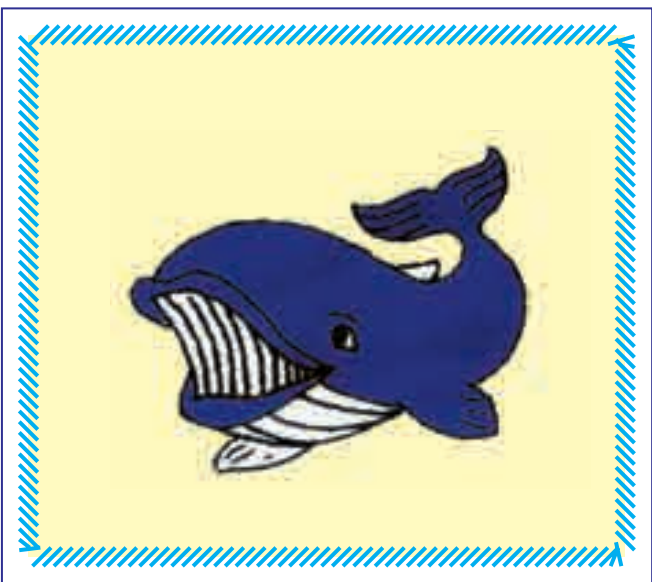
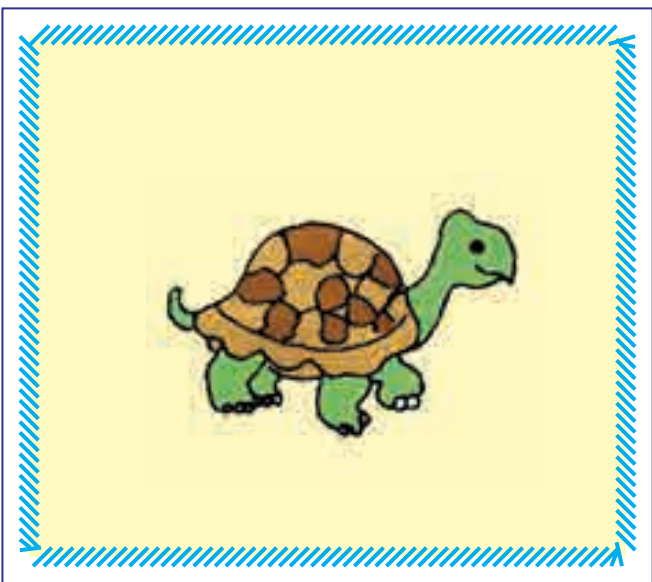
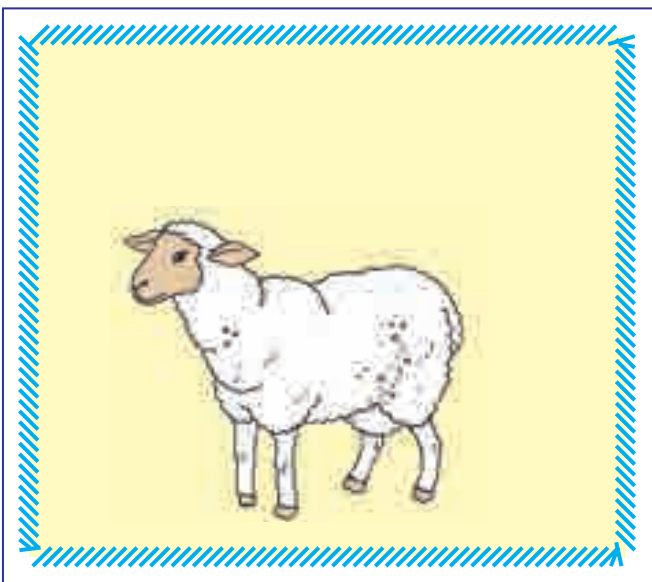
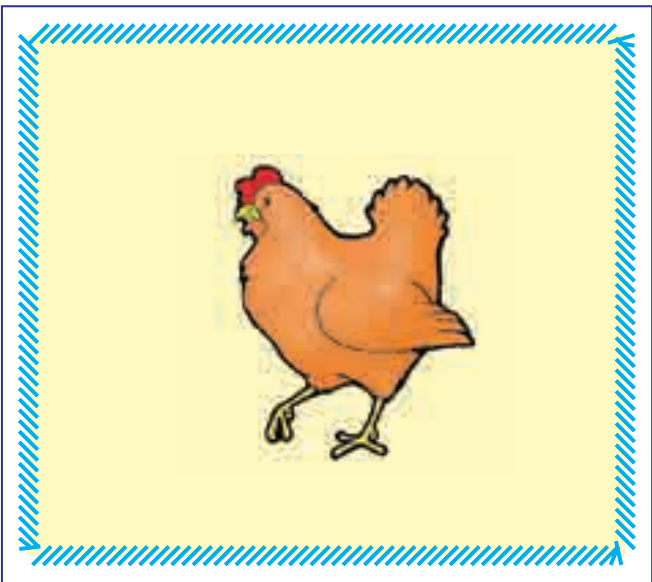
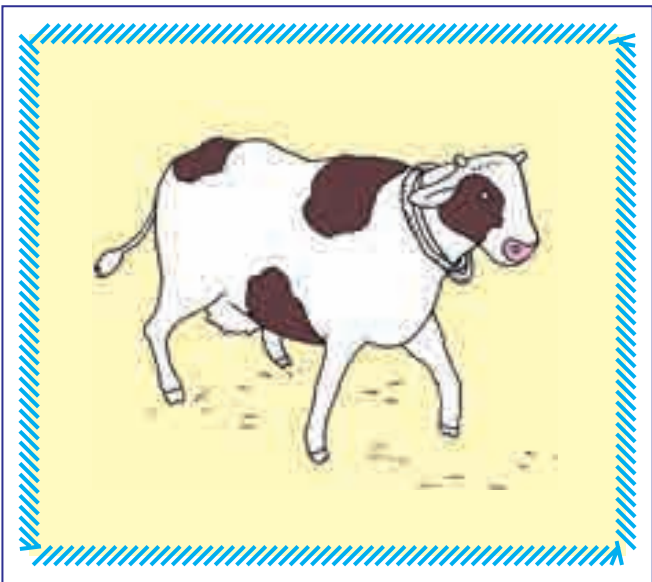
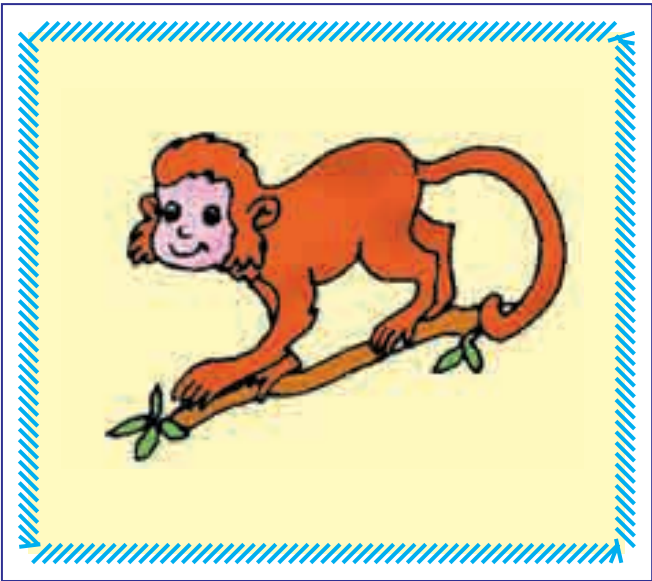
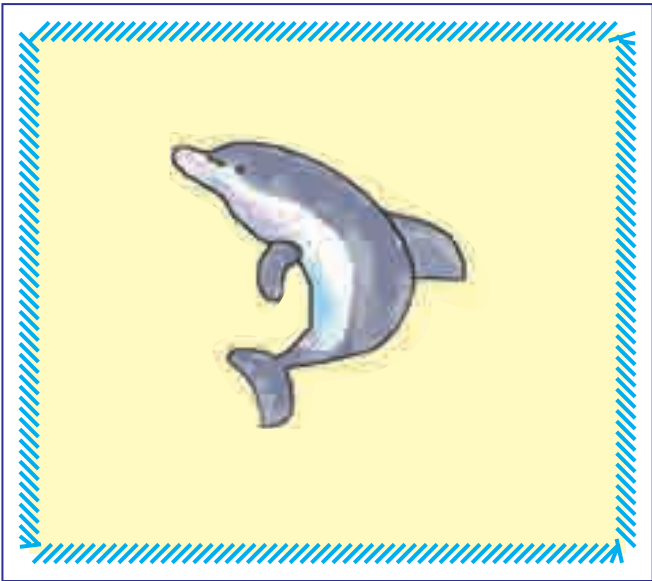

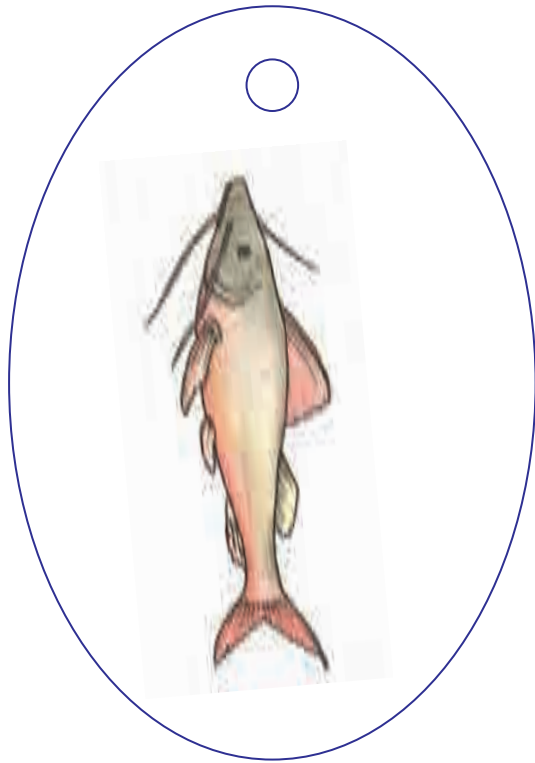
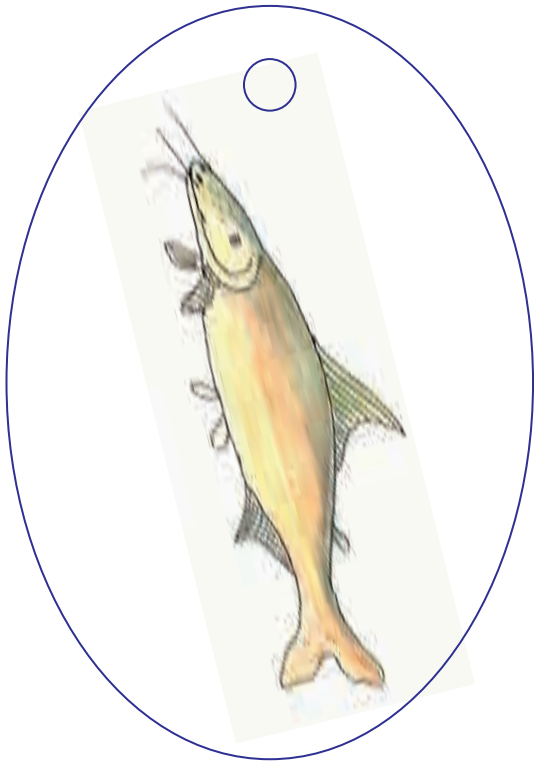
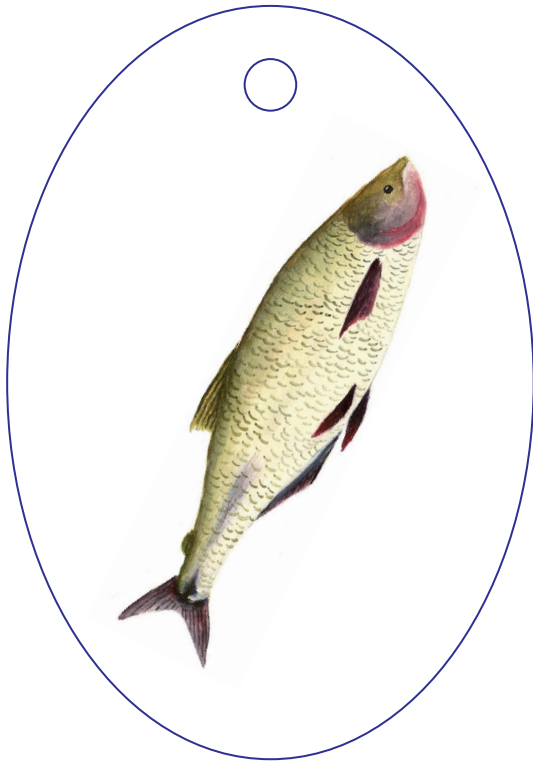
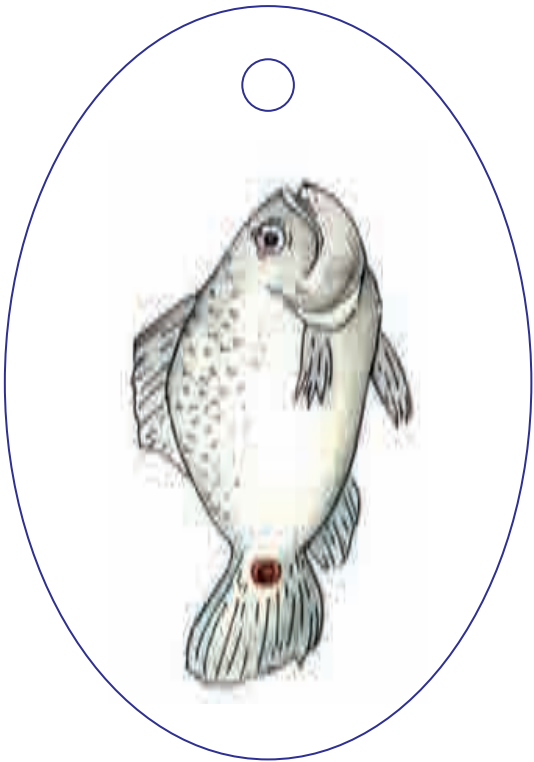
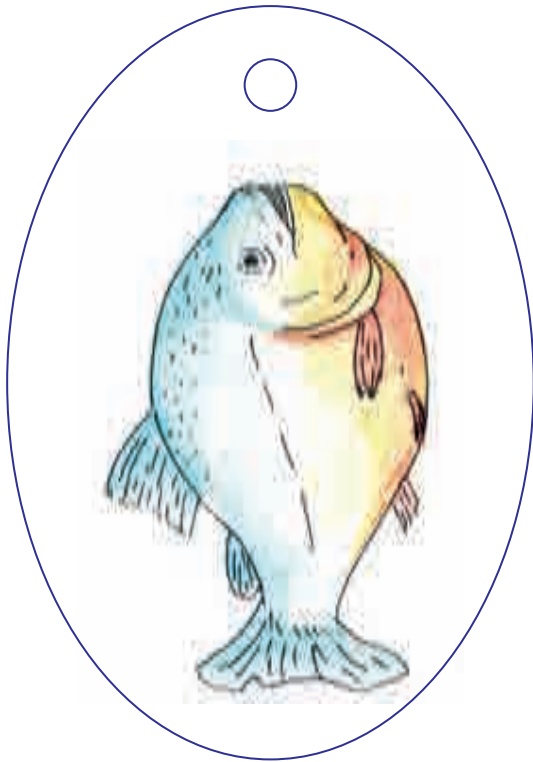



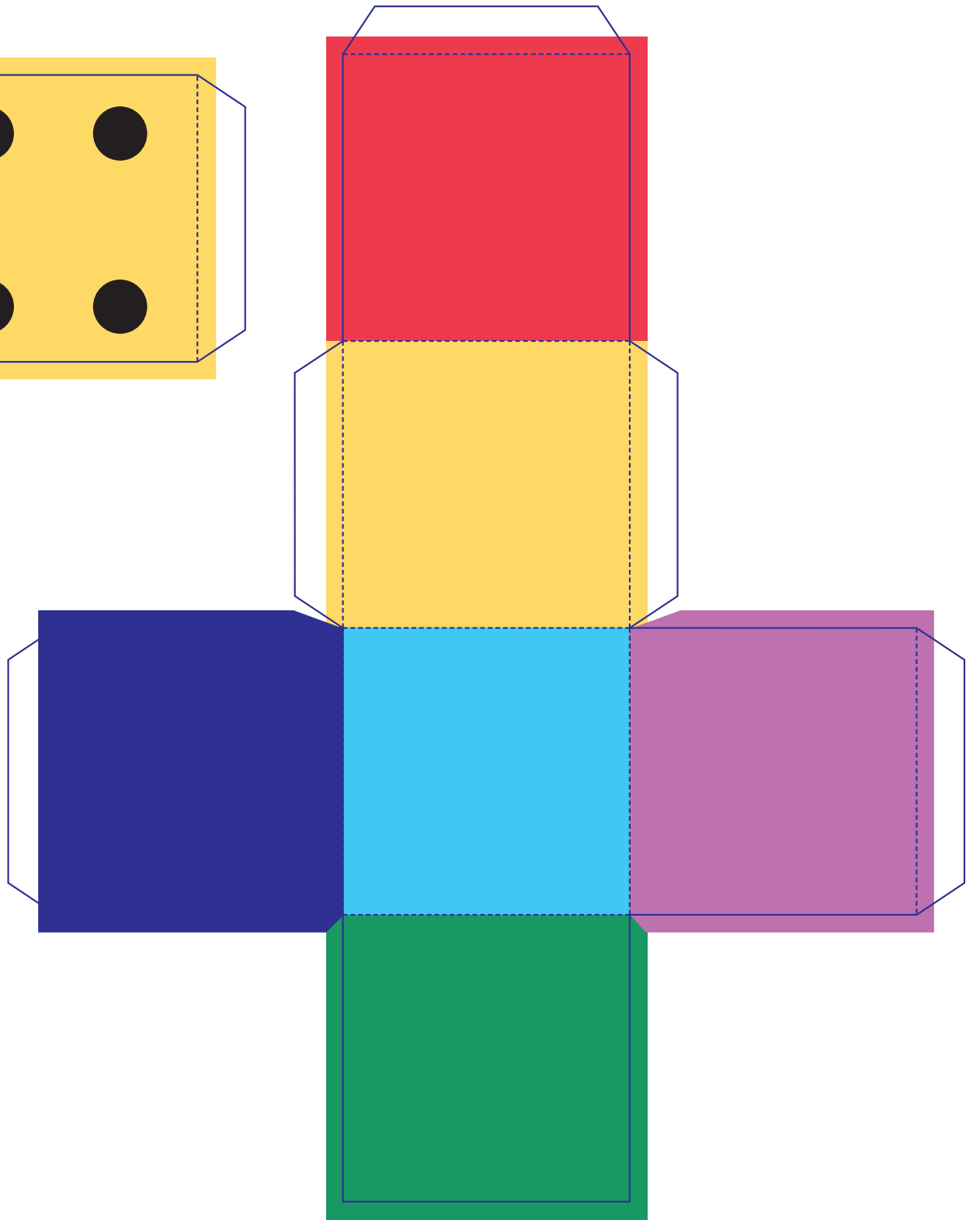
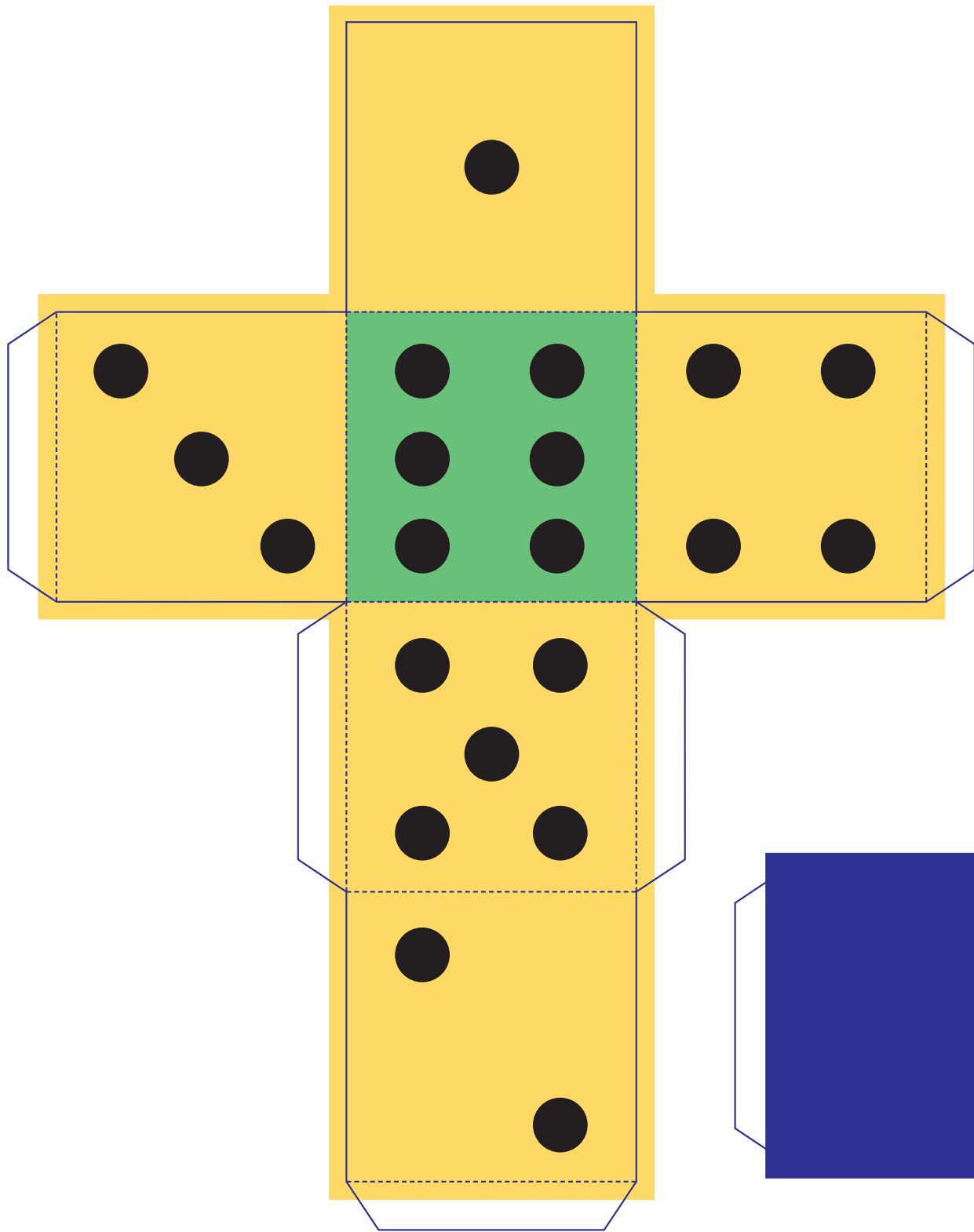



**NAJANAMI
KUNTIN WEGANTU
DAKUMJAMU**



Anugkata juwi

Kashai

Ikam pujuwai, tsawaik
kaninai waajin, kashi
wekainai, yuwai
bataen, pampan,
maman, wakampen
atus.

Anugkata juwi

Yugkipak

Ikamia kuchi yupijam
tutayai, ujeg shuwinai,
duwapeg shiig
pegkejai najantayai
dawenun wegamatai.

Anugkata juwi

Bashu

Ikam bashuk pujuwai
jigkai nugka kakekaun
yuwai, bashuk
patamnai numi kanawe
kampugma ibaunum
yaki.

Anugkata juwi

Chinim

Chinimpik
chijichin
nugkajai
pachimag tenten
pasugmauwai.

Anugkata juwi

Gaviota

Jusha nayantsanum
pujuwai yuwai
namakan yamaik shiig
kuwashat yujakag
yuwinawai aents yutai
ampija utsamun.

Anugkata juwi

Vicuña

Pujuwai muja sejai
nugka tsetseknum,
suweg esagmai,
iyashig uje wajasui
ujushjai betek.

Anugkata juwi

Llama

Batsamnai tsetseknum,
shiig dawa yuwai
dupa aidaun, numi
daeken. Waitkamak
usukkagtinai nuwigtush
tukumkagtinai.

Anugkata juwi

Pelicano

Nayantsa
ajuntaijin
batsamnai
yuwai namak
aidaun.

Wasugkamku unuimagmi

