

# Aymara yatichirija

Arsuña qillqaña yatiqañajataki

1 i



Aymara

Fichas de trabajo de Comunicación  
(lengua originaria L2) - lengua Aimara 1



PERÚ

Ministerio  
de Educación

# La ciudadana y el ciudadano que queremos

Se **reconoce** como persona valiosa y se identifica con su cultura en diferentes contextos.

**Desarrolla** procesos autónomos de aprendizaje.

**Gestiona** proyectos de manera ética.

**Interpreta** la realidad y toma decisiones con conocimientos matemáticos.

**Propicia** la vida en democracia comprendiendo los procesos históricos y sociales.

**Indaga** y comprende el mundo natural y artificial utilizando conocimientos científicos en diálogo con saberes locales.

## Perfil de egreso

Se **comunica** en su lengua materna, en castellano como segunda lengua y en inglés como lengua extranjera.

**Aprovecha** responsablemente las tecnologías.

**Comprende** y aprecia la dimensión espiritual y religiosa.

**Aprecia** manifestaciones artístico-culturales y crea proyectos de arte.

**Practica** una vida activa y saludable.

---

**Currículo**  
N a c i o n a l

1<sup>i</sup>

# Aymara yatichirija

Arsuña qillqaña yatiqañajataki

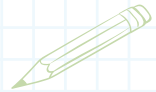

Sutija:

-----

Jichha maraxa: ----- t'aqankthwa

Yatiña utajana jakhuwipa:

-----

Aylluja/markaja:

-----

Yatichirijana sutipa:

-----



Ministerio de Educación

Dirección General de Educación Básica Alternativa, Intercultural Bilingüe  
y de Servicios Educativos en el Ámbito Rural

Dirección de Educación Intercultural Bilingüe

**Aymara yatichirija-Arsuña qillqaña yatiquañajataki**  
**Fichas de trabajo de Comunicación (lengua originaria L2) - lengua Aimara 1°**

Perú Suyuna Yatichaña Chiquañchiri  
193 jakhuni uta, Comercio sutini,  
San Borja markallana thakipa  
Lima Perú  
Jawsaña jakhuwipa: 615-5800  
www.gob.pe/minedu

2021 marana mirayatawa  
Mirayatawa: 7,049 pankanaka  
Impreso en Octubre 2021

**Luriri**  
Rosa Ccopa Ccama

**Uñakipaña yanapiri**  
Edgar Vargas Cayo

**Qillqata uñjaña yanapiri**  
Edgar Vargas Cayo

**Suyunakatha uñakipanirinaka**  
Norma Amanda Huacan Flores (Moquegua)  
Carmen Choquehuanca Roque (Tacna)

**Chiqaparu luraña yanapiri**  
Jaime Barrientos Quispe

**Rixsuri**  
Lucas Pinazo Duran  
Archivo DIGEIBIRA

**Pankaptayiri**  
César Adolfo Yeckle Castro

**Mirayawi uñjaña yanapiri**  
Leoncio Sejje Mamani

Impreso en EDITORIAL ROEL S.A.C.  
Pj. Miguel Valcarcel Nro. 361, Urbanización San Francisco, Ate - Lima  
RUC 20122879331 sutinina luratawa.

Perú Jach'a Suyuna Pankanaka Imaña Utaru Yatiyata  
BNP: N° 2021-09366

Akiri pankankiri qillqatanapaxa janiwa khitisa luririnaka jamasapatha mirayañapati.  
Perú suyuna mirayata / Impreso en el Perú / Printed in Peru



## Uñancht'ayata

Suma munata yatiqiri wawa: Aka aymara yatiqaña pankaxa jumatakiwa. Jupasti yatiña utamana aski yatiqañama yanapt'antamxa.

Yatichirinakawa jumana suma yatiqasa yatiqasa nayraru sartañamataki suma munasiña chuymampi wakichanipxtha. Ukaxa yatichirimampi, awki taykamampi, achachilanakamampi ukhamarusa mayniri wilamasinakamampi yanapt'ayasisa suma yatiqañamatakiwa. Yaqhipa lurawinakaxa yatiqiri masinakamampi lurañatakiwa, ukhamata jumanakpura yanapt'asiñsa yatiqapxañamatakiwa.

Pankankiri lurawinakasti, markasana yatiwinaksa lurawinakapsa aski suma yatxatañamatakiwa, ukhamaraki, aymara aru arsuwimsa, qillqawimsa ch'amañchasiñamataki, jakawisana Pachamamarusa, uywirinakasarusa yäqañasatakiwa. Ukhamaraki ayllusansa, markasansa, yatiña utasansa, utjawisansa jaqi masinakasampi suma sarnaqaña yanapt'arakistanixa.

Aski k'uchi amuyuniwa akiri pankankirinakampixa aruskipaña yatiqataxa, suma jiskht'asiña, jayst'asiña, anatt'asiña, warurt'assiña, uñakipt'asiña, tupayaña ukhamawa, sapa mayni t'aqanakana maymaya yatiqawinaka ch'amancharakita. Aka yatiqaña pankaxa jumana masimjamawa; juparu suma uñjatawa.

¡Suma chuymampi qallantapxañani! ¡Khusäskaniwa!

Perú markasana yatiña irpirinaka.

# Pankankirina uñanchayiripa

1 T'AQA

## Wila masinakasampi aruskipapxañäni



Yatiqa	
1. Aruntasiña yatiqapxañäni	8
2. Aruntasiña yatiqapxañäni	11
3. Wila masinakasampi uñt'asipxañäni	14
4. Wila masinakasampi uñt'asipxañäni	17
5. Masinakasana wila masinakapa uñt'apxañäni	20
6. Masinakasana wila masinakapa uñt'apxañäni	23
7. Yatiqatasa uñacht'ayapxañäni	26

2 T'AQA

## Yapu achunakatha yatxatapxañäni



Yatiqa	
8. Manq'añxata aruskipapxañäni	30
9. Manq'añxata aruskipapxañäni	33
10. Manq'a achunakata yatxatapxañäni	36
11. Manq'a achunakata yatxatapxañäni	39
12. Manq'anaka alapxañäni	42
13. Manq'anaka phayata alxapxañäni	45
14. Yatiqatasa uñacht'ayapxañäni	48

3 T'AQA

## Janchisa uñt'asipxañäni



Yatiqa	
15. Janchinakasata arsupxañäni	52
16. Janchinakasata arsupxañäni	55
17. Manq'anakatha arsupxañäni	58
18. Jani usuntañataki isthapisipxañäni	61
19. Anawa usuntatayna	64
20. Qullayasiri saririna usuntatapata aruskipapxañäni	67
21. Yatiqatasa uñacht'ayapxañäni	70

4 T'AQA

## Yatiqatasatha aruskipapxañäni



Yatiqa	
22. Yatiña utana kunaymana lurañanaka	74
23. Yatiqaña utasana lurawinakapa aruskipapxañäni	77
24. Yatiqawi yänakatha aruskipapxañäni	80
25. Yatiqañataki yänakatha aruskipapxañäni	83
26. Yatiqiri masinakasampi yanapt'asipxañäni	86
27. Yatiña uta samichapxäni	89
28. Yatiqatasa uñacht'ayapxañänixa	92

## Marka qhatu uñjiri sarapxañäni



Yatiqa	
29. Qhaturu achunaka, apapxañäni alxañataki	96
30. Isinaka alasipxañäni	99
31. Manq'añanaka alasinipxañäni phayasiñataki	102
32. Manq'a qhatu manq'iri sarapxañäni	105
33. Qhatuna masinakampi jakisipxañäni	108
34. Jayatha jutiri jaqinaka qullanaka alxiri	111
35. Yatiqatasanaka uñacht'ayapxañäni	114

## Kunaymana uywanaka uñt'apxañäni



Yatiqa	
36. Uta uywanaka uñt'apxañäni	118
37. Wilmaxa utapankiri uywanaka sumachi	121
38. Uywanaka miriri uñjapxañäni	124
39. Uywa qhatu sarapxañäni	127
40. Kunaynama kasta kasta uywanaka	130
41. Uywanaka lakiwasina sallqa uywanaka uñt'apxañäni	133
42. Yatiqatasanaka uñacht'ayapxañäni	136

## Satañampitha, mallkiñampitha aruskipapxañäni



Yatiqa	
43. Jathanaka yapuchañataki uñt'apxañäni	140
44. Phawaña achunakampi phawapxañäni	143
45. Ch'uqinaka kasta kasta satapxañäni	146
46. Ch'uxña alinaka mallkiña yatxatapxañäni	149
47. Ch'uxña muxsa puqutanaka mallkipxañäni	152
48. Quqanaka mallkipxañäni	155
49. Yatiqatasanaka uñacht'ayapxañäni	158

## Markasana Jakawipatha Yatxatapxañäni



Yatiqa	
50. Ayllusana utjawi tuqita yatxatañäni	162
51. Markana utjawi tuqita yatxatañäni	165
52. Julikuxa ayllupana sarnaqawipa yatiyi	168
53. Sunilaxa markana sarnaqawipa yatiyi	171
54. Aylluna thuquwinakapa uñt'apxañäni	174
55. Candelaria mamana phunchhawinakapa yatxatapxañäni	177
56. Yatiqatasanaka uñacht'ayapxañäni	180





1

T'AQA

# Wila masinakasampi aruskipapxañäni



¿Kunjamsa wilamasinakasampi aruskipasipkthana?  
¿Wakisisphati jupanakampi aruskipañäni? ¿Kunathsa?



# 1

## Aruntasiña yatiqapxañäni

YATIQA



¿Kunsa yatiqapxañänixa?

Wilamasinakasampi aruntasipxañäni.

**Suma arumpi aruntasipxañäni**



1. Maya warurt'a ist'apxañäni, kikipa warurt'añataki.



**Kamisaraki wawawanaka**

(Turiru: wirsu)



Kamisaraki quli mama (yatichiri)  
Kamisaraki wawawanaka (taqini) (kuti)

Walikiskthati imilla wawa (yatichiri)  
Walikiskthwa yatichiri (imillanakaki) (kuti)

Walikiskthati yuqalla wawa (yatichiri)  
Walikiskthwa yatichiri (yuqallanakaki) (kuti)



**Akhama arunakampi arsuña yatiqañäni.**

Kamisaraki, walikiskthati, walikiwa,  
walikiskthwa.



## 2. Jiwasapura aruntasipxañäni.

1 Walikiskthati kullaka.

2 Walikiskthwa jilata.

3 Nayasa walikiskarkthwa kullaka.

4 ¿Jumasti walikiskthati?

## Jichhaxa sutisatha aruntasipxañäni.

1 ¿Walikiskthati Ana?

2 Walikiskthwa Arturo.

3 Naya walikiskthwa Ana.

4 ¿Juma walikisktati Arturo?



## 3. Arunaka thaqt' asisa jakisiyañäni.

Sunila

Javier

Waliskisktati

Walikkiskthwa

Juma walikisktati

Naya walikiskthwa

Julia



Akhama arunakampi arsuña yatiqañäni.  
waliskisktati, walikiskthwa, juma walikisktati,  
naya walikiskthwa.



#### 4. Yatichirinakampi aruntasipxañäni.

##### Yatichiri tatampi aruntasiña

1 Walikiskthati yatichiri tata.

4 Naya walikiskarakthwa yatichiri tata.



2 Walikiskthwa imilla wawa.

3 ¿Juma walikiskthati imilla wawa?.

##### Yatichiri mamampi aruntasiña.

1 Walikiskthati yatichiri mama.

4 Naya walikiskthwa yatichiri mama.



2 Walikiskthwa yuqalla wawa.

3 ¿Juma walikiskthati yuqalla wawa?



#### 5. Awkimpipi, taykampi utana aruntasipxañäni.

1 ¿Walikisktati imilla Wawa?

4 Nayaxa walikiskthwa imilla wawa.



7 ¿Jumasti walikisktati yuqalla wawa?

6 Walikiskthwa yuqalla wawa.

5 ¿Walikisktati tataya?

8 Naya walikiskthwa tataya.



2 Walikiskthwa mamaya.

3 ¿Juma walikisktati mamaya?

# 2

YATIQA

## Aruntasiña yatiqapxañäni



¿Kunsa yatiqapxañänixa?

Wilamasinakasampi aruntasiña yatiqapxañäni.

### Wawanaka wilamasinakasampi aruntasiñäni

1 Suma urüphana wilamasinaka.

2 Suma urüphana Ana.

3 Suma jayp'uphana Ana

4 Arumanthikama wilamasinaka.

5 Ana kullaka arumanthikama.

6 Jakisiñkama kullaka.

Janira arskasa



### 1. Maya warurt'a ist'apxañäni, kikiya warurt'añataki.



#### Wilamasisampi aruntasipxañäni



(Warurt'a satiri wirsu)

Wilamasisampi aruntasiñäni. (Kuti)

laralala lal la la la

Suma urükphana, suma jayp'ukphana. (Kuti)

laralala lal la la la

Arumanthikama wilamasinaka, (Kuti)

jakisiñkama wilamasinaka. (Kuti)

laralala lal la la la



Akhama arunakampi arsuña yatiqañäni.

Suma urüphana, suma jayp'uphana,  
arumanthikama, jakisiñkama



## 2. Yatichirinakampi aruntasiñanaka thaqapxañäni.

Yatichiri tatampi, mamampi aruntasipxañäni.

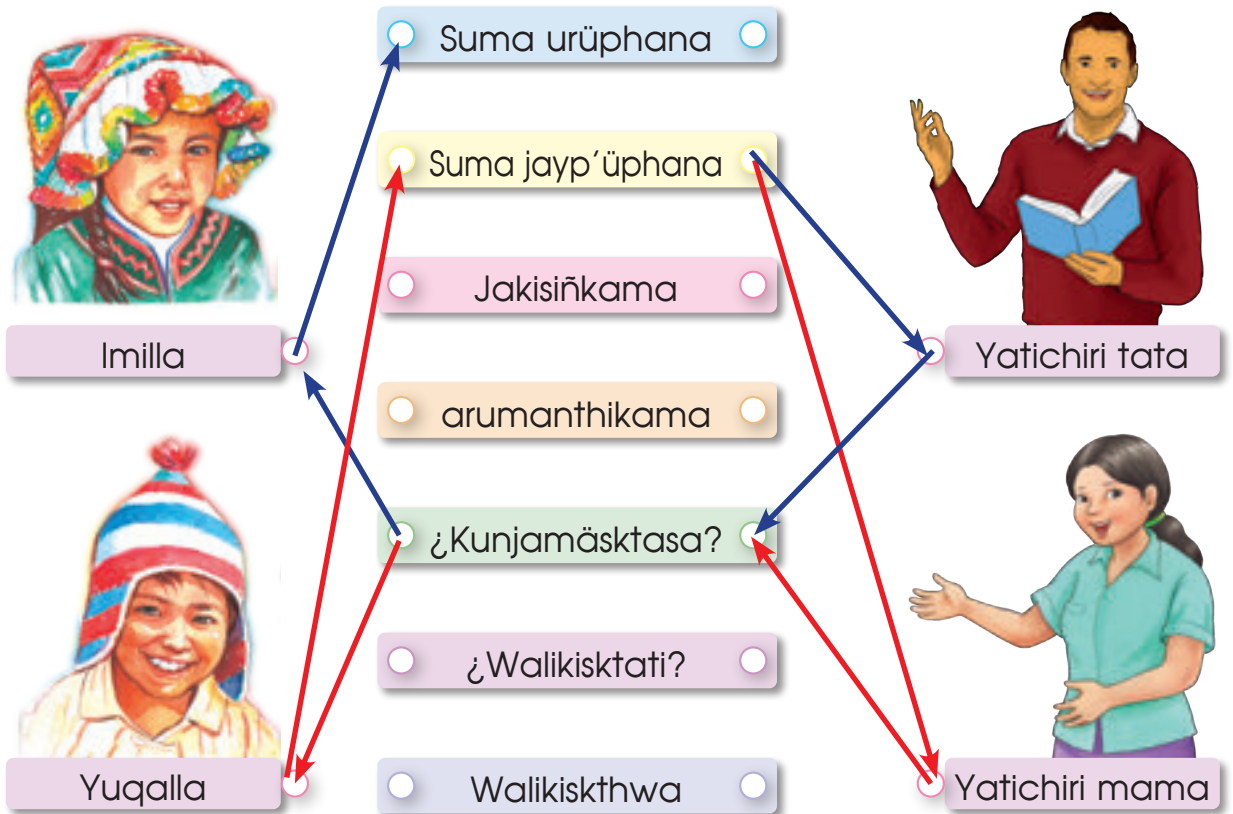

## 3. Jiwaspura aruntasipxañäni.

YATICHIRI	YATIQRIRI
Suma urüphana wawanaka.	Suma urüphana yatichiri. (taqinpacha)
Suma jayp'üphana yuqalla wawanaka.	Suma jayp'üphana yatichiri. (yuqallkamaki)
Jakisiñkama imilla wawanaka	arumanthikama yatichiri. (imillkamaki)

1 Suma urüphana kullaka.

4 Suma jayp'üphana kullaka.

5 Arumanthikama kullaka.



2 Suma urüphana jilata.

3 Suma jayp'üphana jilata.

6 Jakisiñkama jilata.





#### 4. Jiwasapura aruntasipxañäni.

1

Suma urüphana  
*Ana.*



2

Suma urüphana  
*Arturo.*



4

Nayasa walikiskthwa  
*Ana.*

3

¿Juma  
walikiskthati  
*Arturo?*



#### 5. Jichhaxa utasankirinakampi aruntasiñataki wakichasipxañäni.

Akiri arunakampi: tata,  
mama, awki, tayka,  
achachila, awicha.



Akiri arunakampi:  
urüphana, jayp'üphana,  
arumäphana.



Jamuqanakaru  
aruntasiña  
sutinakasampi  
amuyañañi.



Tata suma .....



..... suma .....



..... suma .....



Akiri arunaka arsuña yatiqapxtäna.  
Urüphana, jayp'üphana, arumäphana.

# Wila masinakasampi uñt'asipxañäni



¿Kunsa yatiqapxañänixa?

Jiwaskama uñt'asiña yatiqapxañäni.

## Uñt'asiñxata aruskipapxañäni

1 Naya Kurmi  
sutiniñhwa,  
¿jumasti?

3 Juma Juliku  
sutinitawa.



4 ¿Jumanakaxa  
walisiptati?



2 Waliki Kurmi,  
naya Juliku  
sutiniñhwa

5 Jupa Wilma  
sutiniwa.



1. Maya warurt'a ist'apxañani, ukatha kikipa warurt'apxañani.



## UÑT'ASIPXAÑÄNI

Awki awki - Wirsu

Suma wawanaka,  
uñt'asipxañäni.

Nayampi jumampi,  
Jupasa nayampi,  
uñt'asipxañäni.

Wawanaka uñt'asipxañani,  
Yatichiri uñt'asipxañäni.



Akhama arunakampi arsuña yatiqañäni.

Naya, juma, jupa





## 2. T'ixita muñkanakaru ist'apxañäni.

Walikiskthati jilata,  
**nayaxa Kurmi**  
sutiniithwa, éjuma  
khititasa?



Walikiskthwa  
kullaka, **naya Juliku**  
sutiniithwa, éjuma  
khititasa?



Waliki jilata,  
**naya Wilma**  
sutiniithwa



éJupana  
awkipa  
khitipachasa?



## 3. Maya muyuna taqinimpi uñt'asipxañäni

1

Naya **Endira**  
sutiniithwa, éjuma  
khititasa?

2

Naya **Ernesto**,  
juma **Endira**  
éjupa khitisa?

3

Naya **Mabel**,  
juma **Ernesto**  
éjupa khitisa?

4

Naya **Angel**,  
juma **Mabel**  
éjupa khitisa?

6

Naya **Sunila**  
Juma **Carlos**  
Tukuyapxtanwa.

5

Naya **Carlos**,  
juma **Angel**  
éjupa khitisa?



Akhama arunakampi arsuña  
yatiqapxthana.

Naya, juma, jupa



4. Jichhaxa kikipa muyuna ch'iqasankiri uñt'apxañäni.

1 Naya **Endira** sutinihwa, ¿juma khitiitasa?

2 Naya **Ernesto**, sutinihwa, jupa **Endira** sutiniwa, ¿juma khitiitasa?

3 Naya **Estefanía** sutinihwa, jupa **Ernesto** sutiniwa, ¿juma khitiitasa?

4 Naya **Miguel** sutinihwa, jupa **Estefanía** sutiniwa, ¿juma khitiitasa?

5 Naya **Carlos**, sutinihwa, .....

6 Naya **Sunila** sutinihwa, .....



5. Jichhaxa utasankirinaka uñt'ayañataki amuyapxañäni.



Utasana wilamasinakasaxa akirinakawa:  
Tata, mama, awki, tayka, achachila, awicha, tiyu, tiya.

<b>Awki</b>	<b>Tayka</b>	<b>Jilata</b>	<b>Kullaka</b>
Naya ..... sutinihwa, jupaxa <b>awkijawa</b> , ..... sutiniwa, ¿juma khitiitasa?	Naya ..... sutinihwa, jupa <b>taykajawa</b> , ..... sutiniwa, ¿juma khitiitasa?	Naya ..... sutinihwa, jupaxa <b>jilajawa</b> , ..... sutiniwa, ¿juma khitiitasa?	Naya ..... sutinihwa, jupa <b>kullakajawa</b> , ..... sutiniwa, ¿juma khitiitasa?

# 4

YATIQA

## Wila masinakasampi uñt'asipxañäni

### Marta kullaka wilamasinakapa uñt'ayi



¿Kunsa yatiqapxañänixa?

Wilamasinaka uñt'awasiña yatiqapxañäni.

### Uñt'asiña tuqita aruskipapxañäni

1 Aski urüphana mama, Naya **Ururi** sutinithwa.

2 Aski urüphana **Ururi**, naya **Marta** sutinithwa.

3 Walikiwa mama ¿wilamasinakama uñt'ayitasmati?

4 ijisa!

5 Jupa chachajawa **Firiku** sutiniwa.

6 Juparaki **María** phuchajaxa.

7 Jupa **Alicia** sutiniwa, jila phuchajawa



### 1. Maya katjawi ist'apxañäni.

**KATJAWI**

Walja wawanakani  
Paya chacha warmi  
utjasipxi mä utana

¿kuna pachasa?  
Uñt'apxsnati...



Akhama arunakampi arsuña yatiqañäni.  
Wilamasinakasa uñt'ayaña.



## 2. Marta kullakana wilamasinakapa uñt'apxañäni.



Jupaxa phuchapawa.



Juparaki jila yuqapa.



Jupaxa chachapawa.



Marta kullaka

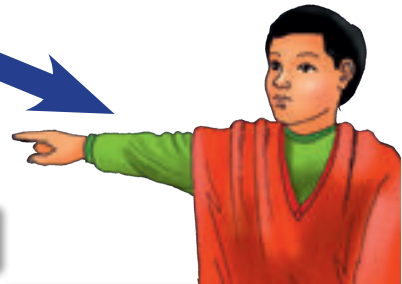

Juparaki jila phuchapa.



## 3. T'ixita muñikanakaru ist'apxañäni.

Jupaxa yuqajawa,  
**Kusi** sutiniwa.

Jupaxa phuchajawa,  
**Ururi** sutiniwa.

Jupaxa awkijawa,  
**Amaru**  
sutiniwa.



Jupaxa taykajawa  
**Alicia**  
sutiniwa.



T'ixita muñikanakampi, akhama arunaka  
arsuña yatiqañäni.

Yuqajawa, phuchajawa, awkijawa,  
taykajawa.



#### 4. Achachilampi aruskipapaxañäni.

1 Achachila, jupa jilajawa, **Kusi** sutiniwa.

2 Naya **Willka** achachiläthwa.

3 Jupa apasajawa.

4 **Ururi** sutiniwa.

5 Jupaxa achachilajawa, **Willka** sutiniwa.

6 **Kamisaraki** achachila, jupa kullakajawa, **Marta** sutiniwa.



#### 5. Juk'ampi arsutanaka ch'amañchaskakiñäni.

### Martana wilamasinakapa uñt'asa jakisiyapxañäni

¿Khitisa Martana sullka phuchapaxa?

¿Khitisa Martana jila phuchapaxa?

¿Khitisa Martana chachapaxa?

¿Khitisa Martana yuqapaxa?



Jupa **Wili** sutiniwa

Naya **Amaru** sutiniñhwa.

Naya **Alicia** sutiniñhwa.

Jupa **Marta** sutiniwa.

5  
YATIQA

# Masinakasana wila masinakapa uñt'apxañani

## Wila masisa uñt'ayañani



¿Kunsa yatiqapxañanixa?

Wilamasinakasampi uñt'asisa yatiqapxañani.

### Uñt'ayaña tuqita aruskipapxañani.

1 Awkijaxa *Pedro* sutiniwa, ¿jumansti?

4 Kimsa sullkanakanithwa; *Amaru, Willka, Ajayu* ukhama sutininaka.

2 Nayana awkijaxa *Oscar* sutiniwa.

3 Nayana awkijaxa *Lucas* sutiniwa, taykajaxa *Fermina* sutiniwa.



### 1. Maya warurt'a ist'apxañani, ukatha kikipa warurt'apxañani.

WILAMASI

Warurt'a



Wilamasi, wilamasi

Awkija, taykaja

Jach'a jilata

Jisk'a kullaka

Wawalla, wawalla. (kuti)



### Aymarata warurt'asa, jumana masinakama uñt'añani.

Awkija, taykaja, jilataja, kullakaja, ...



## 2. Yatichirimpi aruskipapxañäni.



Awichaja *Dionisia* sutiniwa, éjumansti?

Nayana taykajaxa Tunata sutiniwa.



Nayana payawa sullkajaxa.

éQhawqha sullkanakanitasa?



## 3. Awki taykampi aruskipapxañäni.

1 Jila tataja *Satuku* sutiniwa.

3 Jila mamajaxa *Aquilina* sutiniwa.

2 éKunasa jila mamamana sutipa?

4 éQhawqha wawanakanisa jila tatama?

5 Kimsa wawanakaniwa.

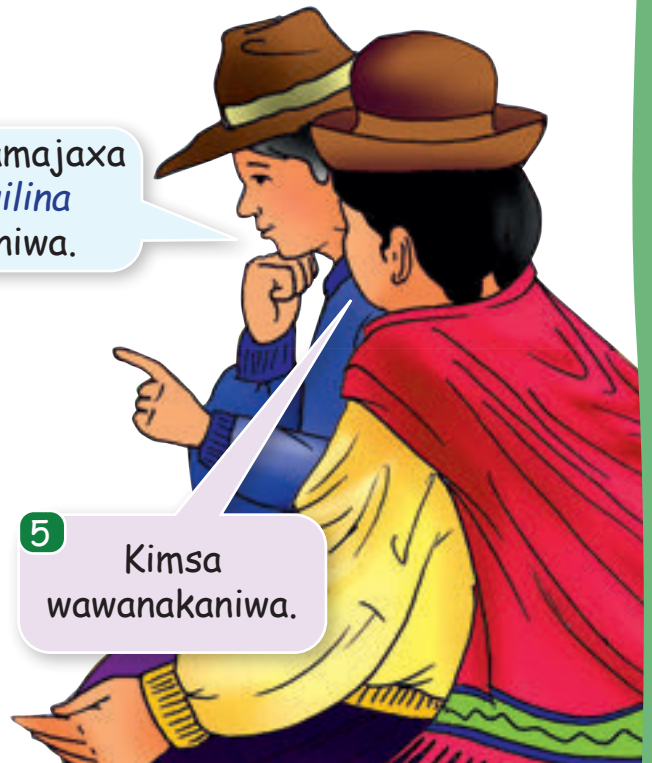



#### 4. Jamuqanakana uñxatasa jakisiyapxañäni.

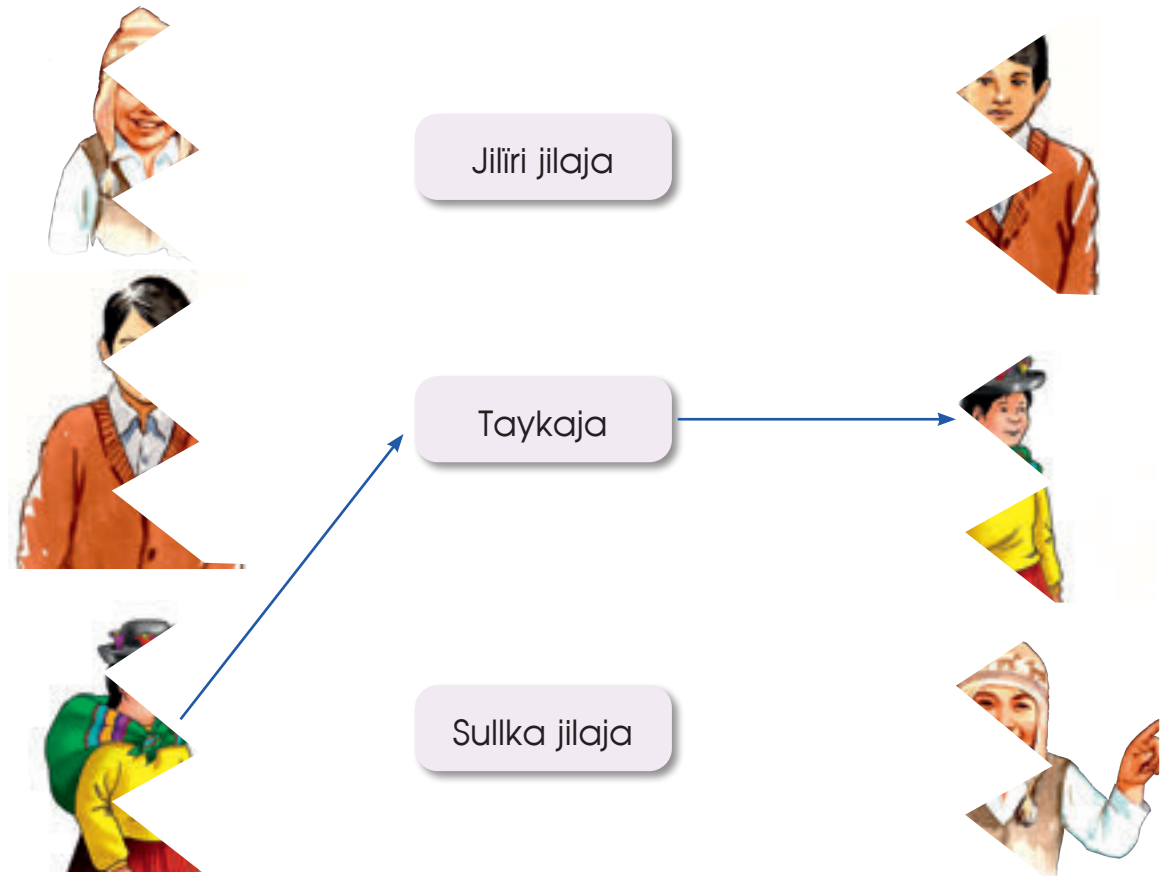

#### 5. Akiri arunaka aski amuyawasina irpthapipxañäni.

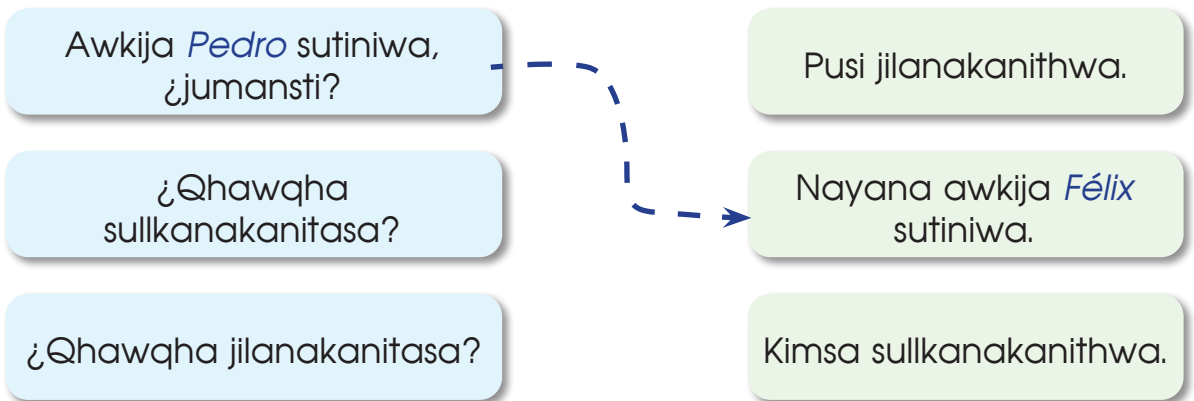

#### Aymara aruta k'atampi akiri arunaka ch'amañchaskakiñäni.

Nayana	Jumana	Jupana
Awkija	Awkima	Awkipa
Taykaja	Taykama	Taykapa
Jilaja	Jilama	Jilapa
Sullkaja	Sullkama	Sullkapa



# 6

YATIQA

## Masinakasana wila masinakapa uñt'apxañäni

### Mayninakana wilamasinakapa uñt'apxañäni



¿Kunsa yatiqapxañänixa?

Jiwaskama wila masinakasampi uñt'asipxañäni.

### Mayninakampi uñt'asiña tuqita aruskipapxañäni

1

Jupaxa **Willmana** awkipawa, **Awriku** sutiniwa. ¿Uka mayni khitisa?

2

Jupaxa **Marinana** jilapawa, **Inti** sutiniwa. ¿uka mayni khitisa?

3

Jupaxa **Marinana** taykapawa, **Martina** sutiniwa. ¿Uka mayni kullakasti?

4

Jupaxa **Marinana** kullakapawa, **Millka** sutiniwa.



### 1. Taqapachani akiri warurt'a ist'asa warurt'apxañäni.

#### Masijana wila masinakapa Wirsu - sarxaja



Jupaxa nayana masijawa  
Jumasa nayana masijätawa,  
Masijana awkipaxa Qinti sutinirakiwa,  
masijana taykapaxa Marta sutinirakiwa.

Jupaxa nayana masijawa  
Jumasa nayana masijätawa,  
Masijana jilapaxa Wili sutiniwa,  
masijana kullakapaxa Willma sutiniwa.



#### Akhama arunakampi arsuña yatiqañäni.

Jupana, nayana, jumasa, masijana.



## 2. Jiwaspura panini panini amuyapxañäni kunjamapachasa.

Ururina awkipaxa **Phirikuwa**, ¿taykapa khitisa?

**Mariyana** awkipaxa ¿kuna sutiniipachasa?



Juwansuna taykapaxa **Kunsichawa**, ¿jilapa kunjamapachasa?



**Julikuna** taykapaxa phiruwa, ¿taykapa khitisa?



## 3. Wilamasisana kankañanakapa uñt'apxañäni.

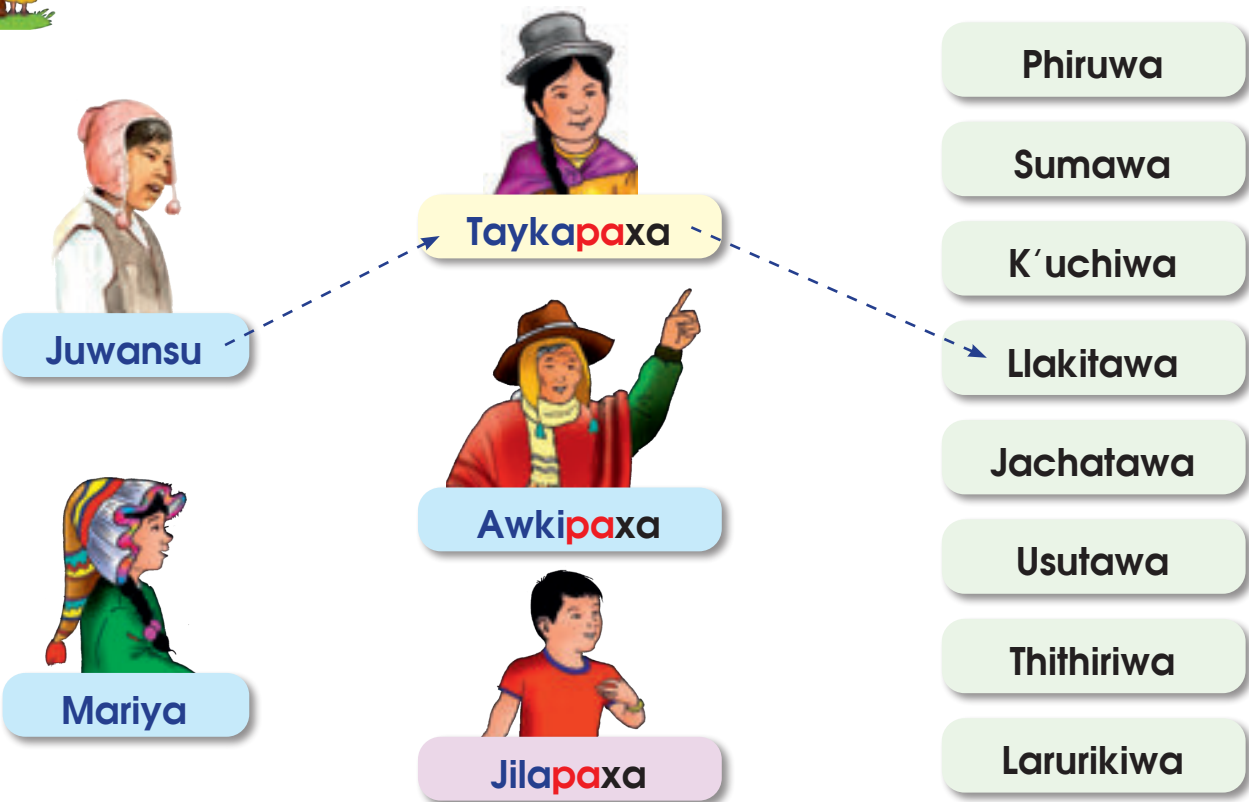



#### 4. Masinakasana kankañanakapa rixsuwasina uñt'apxañäni.

Achachilapa

Taykapa

Awkapa

Jilapa

Awichapa



Nayaxa  
kankañakapa  
rixsujaxa

Kullakapa



#### 5. Masijana wilamasipana kankañanakapa phuqachapxañäni.



# 7

## YATIQA

# Yatiqatasa uñacht'ayapxañäni



### ¿Kunsa yatiqapxañänixa?

Yatiqatasa sapa mayni uñt'apxañäni, ukata akhama  sich'impi sich'intapxañäni.

Kunanaksa yatiqatatxa uka uñakipaja	Janirawa yatiqkti 	Yatiqawtha 
1. Suma arumpi aruntasipxañäni.		
2. Ana wilamasipampiwa aruntasi.		
3. Jiwaskama uñt'asipxañäni.		
4. Marta kullaka masinakararuwa uñt'ayi.		
5. Wilamasinakasa uñt'ayañäni.		
6. Mayninakana wilamasinakapa uñt'añäni.		

### ¿Kunsa lurapxañänixa?

Wilamasisana quqapa lurapxañäni yänakata jiwaskama uñt'asiñataki.



## Wilamasina quqapa



### 1. ¿Kuna yänakasa wakisi wilamasi quqa lurañataki?

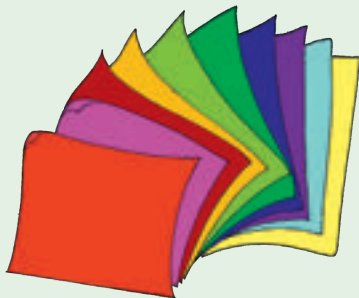

Samichata laphinaka



Llip'iyaña

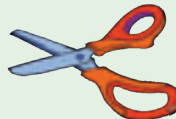

khuchuña



Wilamasisana jamuqanakapa



## 2. ¿Kunjamsa Wilamasina quqapa lurapxañäni?



**Jamuqa talliqaña.**



**Jamuqa khuchuña.**



**Muxsa puqutaru jamuqa  
llip'intayaña.**



**Muxsa puqutaru jamuqa  
llip'intayata.**



**Quqaru laphinakapa  
llip'irayaña.**



**Quqaru jamuqanaka  
llip'irayaña.**



**Wilamasisana quqapa tukuyata.**



3. Yatiqiri masinakasampi wilamasisana quqapa uñakipaxañani.

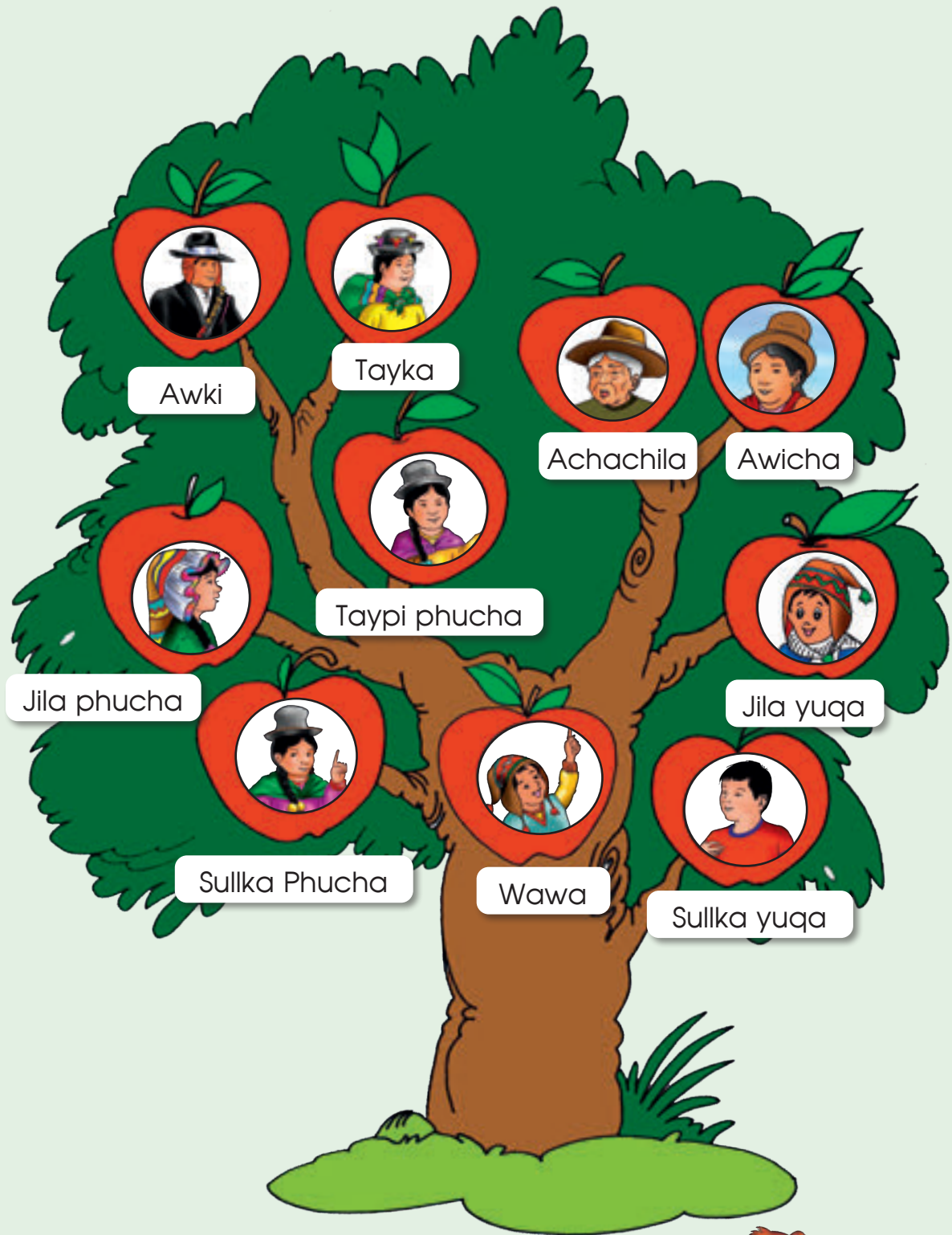

Jichhaxa utamana wilamasinakamaru  
luratama uñxatayma.



2

T'AQA

# Yapu achunakatha yatxatapxañäni



¿Kuna manq'aña achunaksa uñt'apxtana?  
¿Wakisisphati manq'aña achunakata arsuña?



# Manq'añxata aruskipapxañäni

## Manq'anaxatha arsupxañäni



¿Kunsa yatiqapxañänixa?

Manq'anakata jiskht'asisa aruskipasa yatiqapxañäni.

## Manq'aña wakichasiñata aruskipapxañäni



1. Maya warur'ta ist'apxañäni, kikipa warur'tañataki.



Suma ququsiñataki  
Wila jatha - wirsu



Kunsa manq'tha,  
kunsa manq'tha. (kuti)  
Nayaxa ququ manq'asisktha  
Ququ manq'asisktha  
Jilata, kullaka... (kuti)





## 2. Kuna manq'aña achunakasa ququ phayasiñatakixa.

J A  
C Q  
I  
T  
Y J



## 3. Ch'uqi alxiritha aruskipapxañani.

Mamaya akiri achunakampi: jiwra, ch'uqi, apilla ékuna manq'anaksa phayasipxsna?



Wawa jiwra achumpi k'ispiña, jiwra taxti phayañaxa.

Ch'uqi achumpi munta qhati, qhati phuti phayasipxsna.

Apilla achumpi apilla phuti, thayacha phayasipxsna.



4. Achunaka uñxatawasinasapanaka, waljanaka jakisiyapxañäni.

Jawasa

Ch'ujinaka

Apilla

Jawasanaka

Ch'uji

Apillanaka



5. Utamankirinakampi jamuqanaka uñxatawasina, uñt'apxañani sapanaka waljachirinaka ukata sich'intapxma.

Jamuqanaka	Sapa	Walja
	Ch'uji <input type="radio"/>	ch'ujinaka <input checked="" type="radio"/>
	Jiwra <input type="radio"/>	Jiwrana <input type="radio"/>
	Jawasa <input type="radio"/>	Jawasanaka <input type="radio"/>
	Isañu <input type="radio"/>	Isañunaka <input type="radio"/>
	Apilla <input type="radio"/>	Apillanaka <input type="radio"/>



**Akiri arunakampi arsuña yatiqañäni.**  
**Apilla, apillanaka, Ch'uji, ch'ujinaka.**

# 9

YATIQA

## Manq'añxata aruskipapxañäni

### Ququ phayañataki wakisiri achunaka



¿Kunsa yatiqapxañänixa?

Ququ phayañataki achunakatha aruskipapxañäni.

### Ququ phayaña tuqita aruskipapxañäni

2

¿Kunjamasä ququ phayasiñaxa?

1

Awicha, nayaxa ququ phayasiña muntha.



3

¿Kuna achunakampisa phayasnaxa?

4

¿Uñt'tanti uka achunaka?



### 1. Maya warurt'a ist'apxañäni, kikipa warurt'añataki.

**Phayasiri imilla**  
Satiri - wirsu

Phayiri, phayiri q'apa imillalla,  
Qhirimpi chikaki juma jakastaxa.  
La la lal lal lal  
Chuq'i phayatamasa wali sumakiwa,  
Thaxthi thaxthitamasa suma  
pululukama,  
Masinakasaru ch'ama ch'amañchiri.  
La la lal lal lal





2. Jichhaxa anat'asa aruskipaña thaki arkawasina achunakana sutinakapa ch'amampi arsuyapxañäni:

Akiri achunakampi ékuna ququnaksa phayt'asiriktha?

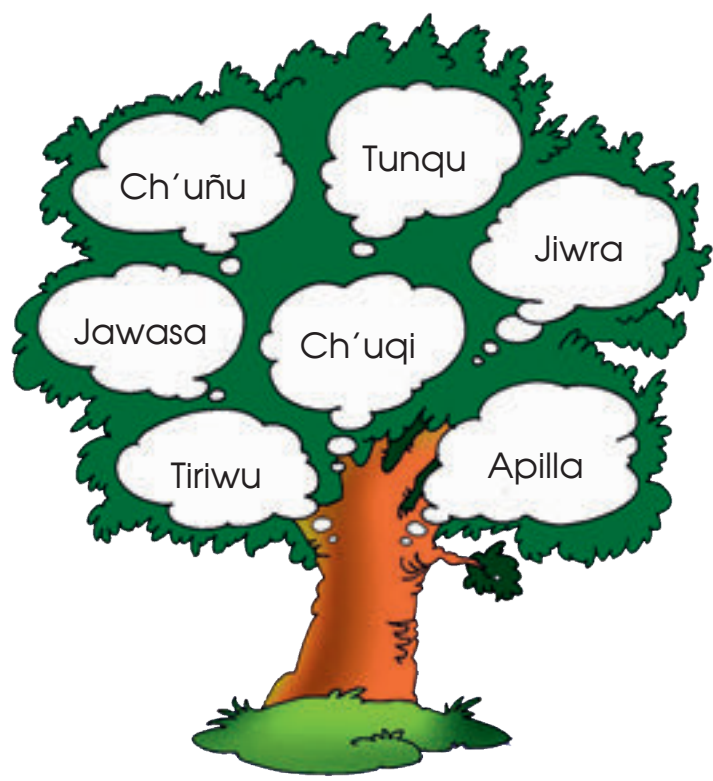

3. Akiri quqana achunakapata ¿kuna ququnaksa phayasnaxa? Wali jilañataki.



Jach'a jilañatakixa

- Jiwra juchha phayasnaxa.
- Ch'uqi phuthi phayasnaxa.
- Jawasa mut'i phayasnaxa.
- Apilla qathi phayasnaxa.
- Ch'uñu phuthi phayasnaxa.
- Tunqu mut'i phayasnaxa.
- Tiriwu jamp'i phayasnaxa.



4. Anat'asa sapa qillqa apañani aynachawjaru yatiñataki  
¿Kunasa jiwrata phayasixa?

K' i s p i ñ a    p h u t i w a    p h u t i s i ñ a

Jiwrata ¿kunsa phayasnaxa?



5. Masinakasampi Katjapxañani kuna ququnaksa markasa phayasixtana ukanaka.

Siwichi       Ch'uñu phuthi  
 K'ispiña phuthi       Jawasa mut'i       Juwani



Akhama arunakampi arsuña yatiqañani.

Manq'anakana sutipa: k'ispiña phuti, ch'uñu phuti, jawasa mut'i, thaxti ...

# Manq'a achunakata yatxatapxañäni

**Ququtaki wakisiri ch' uqinaka.**



**¿Kunsa yatiqapxañänixa?**

Ququ phayasiñataki wakisiri ch' uqinaka uñt' aña.

**Kunaymana ch' uqinakana phayasiñataki uñt' apxañäni**

1 Kunaymana ch' uqinakawa ququ phayasiñataki wakisi.

2 ¿Kuna chuq' isa ukaxa?

3 Ch' iyara imillawa.

4 ¿Kunaraki akasti?

5 Qumpiwa.

6 ¿Khayasti kunaraki?

7 Janq' u imillawa.

8 ¿Ukayristi?

9 Akaxa luk' i ch' uqiwa.



**1. Maya warurt' a ist' apxañäni, kikipa warurt' añataki.**



**KASTA CH' UQINAKA**

Allphachu awatiri - wirsu



Kasta ch' uqinaka uñt' apxañäni  
Utjarakiwa luk' inaka



Utjarakiwa sayanaka. ( kuti)

Kasta ch' uqinaka uñt' apxañäni  
Ch' iyara imilla, janq' u imilla



Kasta ch' uqinaka uñt' apxañäni  
Wank' u sullu, chikilla. ( kuti )

¡Jallallaphana pachamamasa! (2 Kuti)





## 2. Ququ wakichaña ch'uqinaka uñt'apxañäni.

					W										
C					A										
			J		N										
			L		K'										
				Q	U										
					S										
					U										
					L										
					U										
					L										
					U										
					C	H'	A	S	K	A					



## 3. Jumaxa, ¿kawkiri ch'uqinakampisa jilpacha ququ phayastaxa?

  
Nayaxa

  
Jumaxa

  
Jupaxa

Wayrumpi

Qumpimpi

Ch'iyara imillampi

Janq'u imillampi

Ch'askampi

Chikillampi

Luk'impipi

  
jilpacha phayasta.



**Arunakampi arsuña yatiqañäni.**  
Naya, juma, jupa, ...



4. Kawkch'a ch'uqinakasa wakisi ququ phayañataki uka samichapxañäni.



Jach'anaka

Murmunaka

T'unanaka

Muntanaka

Jisk'anaka



5. Masinakajaru ch'uqi phuthi phayañata yatiyaxa.

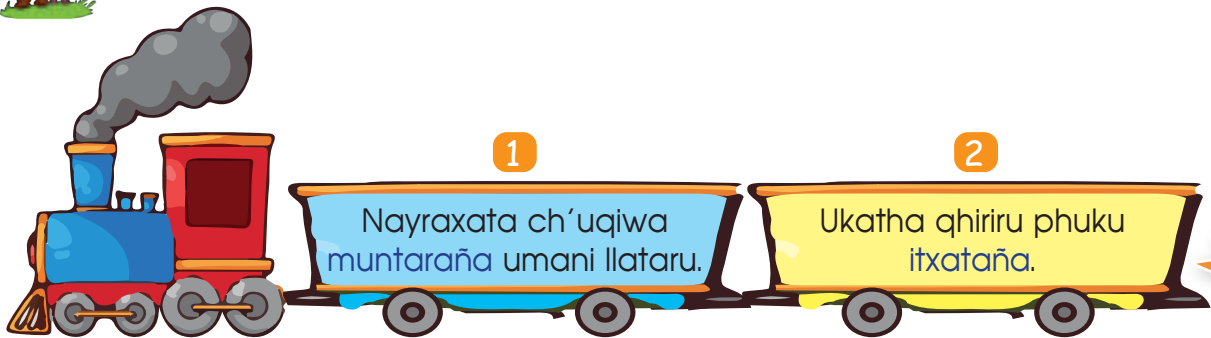

**Aymarata akhama arunakampi arsuña yatiqañäni.**

muntaraña, itxataña, phayasiña, wallaqiyaña.



# 11

YATIQA

## Manq'a achunakata yatxatapxañäni

### Phayasita taqini ququsipxañäni



¿Kunsa yatiqapxañänixa?

Arsusa yatxatapxañäni kuna ququ phayatasa munasitaspaxa taqi mayniruxa.

### Ququsiñata aruskipapxañäni

1 ¿Phayata ququ manq'aña munaptati?

2 Jisa, ququ manq'aña munapxthwa.

3 ¿Kuna ququnakasa jumaru munastäma?

4 Nayaruxa ch'uñu, kaya, jawasa, thaxthi. uka ququnakawa munasitu.

5 Ukhamaxa munatasaru ququsipxañäni.



### 1. Maya warur't'a ist'apxañäni, kikipa warur't'añataki.



#### Suma ququsiñataki

Wila jatha – wirsu

Kunsa manq'tha,  
kunsa manq'tha (kuti)  
Nayaxa,  
ququ manq'asisktha  
ququ manq'asisktha  
Jilata, kullaka. (kuti)



#### Akiri arunakampi arsuña yatiqañäni.

Ququ manq'asisktha, ququ phayasiscktha, ...



## 2. Kunaymana ququnaka uñt'apxañani:



Nayaxa manq'aña munthwa.

- Ch'uñu phuti
- Jawasa mut'i
- Tunqu mut'i
- K'ispiña phuti
- Kaya phuti



## 3. ¿Kuna ququnaksa ayluma phayasipxtasti? Uka uñt'apxañani.

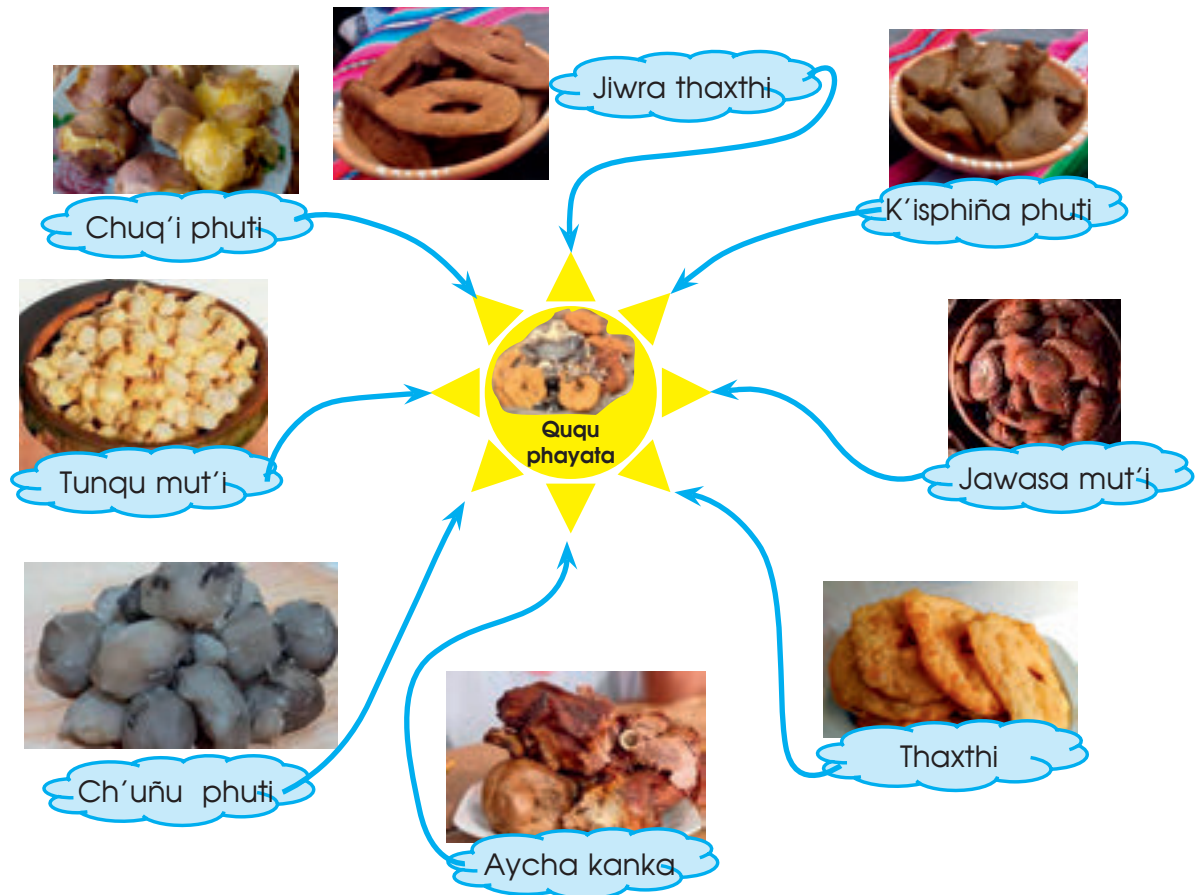



#### 4. Masinakasampi wasitata aruskipapxañani.

Nayaruxa k'ispiñawa munasitu.



Jumaruxa jawasa phutiwa munastama.



Juparuxa thaxthiwa munasi.



#### 5. Utamana yatiqata arunakampi aruskipapxanta.

Nayaruxa



k'ispiñawa



munasitu

Jumaruxa



jawasa phutiwa



munastama

Juparuxa



Thaxthiwa



munasi



**Akhama arunakampi arsuña yatiqañani.**

Nayaruxa, jumaruxa, juparuxa.

## Achunaka alakipasipxañäni



¿Kunsa yatiqapxañänixa?

Ch'uqinaka alakipaña tuqita yatxatapxañäni.

## Achunaka alakipasiñata aruskipapxañäni

2

Alasipxitaya,  
chaninakapasa  
iraqatakiwa.

4

Päya sulisa chikataniwa  
kilu ch'uqixa.



3

¿Isañumasti?

1

Kullaka  
éqhawqhasa  
ch'uqimaxa?



1. Maya warurt'a ist'apxañäni, kikipa warurt'añataki.



## MANQ' AÑA ACHUNA CHANIPA

Balserito - wirsu

Wawanaka yatxatañani manq'aña.

Achuna chaninakapa

Qhawqhasa kilu ch'uqixa

Paya sulisawa,

Qhawqhasa kilu tunquxa,

Kimsa sulisawa

Aruwa jawasaxa ,

Pusi tunka sulisawa

Chaninakapa yatiñatakixa, alasiñawa  
rumanillampi. (kuti)



## 2. Jichhaxa achunaka alxaña tuqitha aruskipañani.

Suma ch'amañchiri  
jiskht'anaka



¿Qhawqhänsa kilu  
ch'uqixa?

¿Qhawqhänsa isaña  
chanipaxa?

Amuyasita  
kutt'ayatanaka



Paya sulisa  
chikataninwa.

Paya sulisawa  
chanipaxa.



## 3. Luk'anamampi yanapt'asisna katjma alxaña achuna chaninakapa.



S/. Paya sulisa  
chikatani



S/. Kimsa sulisa



S/. Pusi tunka  
sulisa

¿Qhawqhasa kilu  
ch'uqixa?

¿Qhawqhasa kilu  
tunquxa?

¿Qhawqhasa aruwa  
jawasaxa?

Kimsa sulisawa  
chanipaxa.

Pusi tunka sulisawa  
chanipaxa.

Paya sulisa chikatanitawa  
chanipaxa.



**Akiri arunaka arsuña yatiqañani.**

Manq'aña achunakana ¿Qhawqhasa  
chanipa?



4. Luk'anamampi yanapt'asiwasina katjma alxaña achunanakana chanipa.

		S/. Pusi tunka sulisa
<b>¿Kawkiri achuna chanipasa juk'axa?</b>		
Ch'uqi	Tunqu	Jawasa



5. Luk'anamampi yanapt'asiwasina sarayma kunjamasa tupunakampi achunakana chaninakapa yatxatsnaxa.

**Rumana**

¿Qhawqhasa aruwa jawasasti?

Pusi tunka sulisawa chanipaxa.

**Walansa**

¿Qhawqhasa kilu tunquxa?

Kimsa sulisawa chanipaxa

¿Qhawqhasa kilu ch'uqixa?

Paya sulisa chikatanitawa chanipaxa.



**Yatiñatakixa alxaña achunaka rumanampi, walansampi waytixa, chaninakapa uñt'añataki.**  
**Tupuñanakampiwa liwrati, kilucha, aruwacha, achunaka waytapxixa.**

# Manq'anaka phayata alxapxañäni

## Wilma kullakaxa manq'a phayata alxi



¿Kunsa yatiqapxañänixa?

Wilma kullakana phayaña tuqita arsutapa amuyañäni.

## Phayaña tuqita aruskipapxañäni



2 ¿Qhawqharaki alapasti?

1 Kullaka, manq'a alasita, suma phayatawa.

3 Iraqatakiwa

4 ¿Kuna manq'a phayatanakasa utjtama?

5 Utjiwa: tunqu allpi, chayru, chawlla wallaqi, ulluku wayk'a.



## 1. Maya katjawi ist'apxañäni, ukatha kutt'ayapxañäni.



**Katjawi**  
Quri ñik'uta qullqi  
laka ch'akalla  
Llullu kankallampi  
muxsa manq'allaki.  
**¿Kunapachasa?**



## Akiri arunaka arsuña yatiqañäni.

Manq'a phayata alxita, ¿qhawqhasa alapaxa?



## 2. Wakichasipxañani **nayra**, **jichha**, **qhipa pacha** manq'a phayata alxañataki.

**Nayra pacha**



Phayañatakixa wakichañawa kunaymana yänaka



Chuxña alinakawa alañäxa.

**Jichha pacha**



Phayañaniwa kunaymana kasta manq'anaka.



Jiwra jawch'a, t'impu phayapxaraktha.

**Qhipa pacha**

Rikuwana taypiruwa alxiri apapxixa.



Suma manq'anaka alxapxani.





### 3. Jamuqanaka uñxatawasina aruskipapxañäni.



### 4. Arunaka suma amuyasa jakisiyapxañäni.



Taykaxa

nayra uru manq'a

jichha uru manq'a

qhipa uru manq'a

alxi

alasina

phayi

manq'asina

apani

apäna



**Akiri arunaka arsuña yatichistu.**



Nayra pacha, Jichha pacha, Qhipa pacha.

# Yatiqatasa uñacht'ayapxañäni



## ¿Kunjamsa yatiqatasa uñacht'ayapxañänixa?

Yatiqatasa sapa mayni amtapxañäni, ukata akhama  sich'impi sich'intapxañäni.

Kunanaksa yatiqatatxa uka uñakipaja	Janirawa yatiqkti 	Yatiqawtha 
1. Manq'añxatha arsupxañäni.		
2. Kuna achunakasa wakisi ququ phayasiñataki.		
3. Kunjama ch'uqinakasa wakisi ququtaki.		
4. Munatasa phayata ququsipxañäni.		
5. Achunaka alakipasipxañäni.		
6. Wilma kullakaxa manq'a phayata alxi.		

## ¿Kunsa lurapxañänixa? K'ispiña phutiña yatiqapxañäni



### K'ispiña phutiña

#### 1. ¿Kuna yänakasa wakisi k'ispiña lurañataki?



Jiwra aqallpu



jayu



Q'atawi



uma



phuku



Khiri pullu



## 2. ¿Kunjamsa k'ispiña lurapxañäni?

1. Nayraqataxa jayumpi, q'atawimpi umampi aqallpuru warxataña.



2. Ukxaruxa amparampiwa aqallpu ñatsuña.



3. Ukhama ñatsuwasina amaparampi q'apsuña.



4. Ukatwa qhiri pulluru ñiq'i phukuru phutsuña.



5. Ukhamawa qhatiyawasina k'ispiña ququsiña.



### 3. ¿Kunjamsa uka luratasa uñacht'ayañänixa?

1. Nayraqataxa sawuta isi luririnakjamawa amuyapxañäni.



2. Panini paniniwa luratasatha aruskipapxañäni.

1

Nayraqataxa  
jayumpi, q'atawimpi  
umampi aqallpuru  
**warxataña.**



2

Ukxaruxa  
amparampiwa  
aqallpu  
**ñatsuña.**



3

Ukhama  
ñatsuwasina  
amaparampi  
**q'apsuña.**

4

Ukatwa qhiri  
pulluru ñiq'i  
phukuru  
**phutsuña.**



5

Ukhama  
k'ispiña aski  
**qhatiyaña.**



6

Qhiparuxa  
qhatiyawasina  
k'ispiña  
**ququsiña.**



3

T'AQA

# Janchisa uñt'asipxañäni

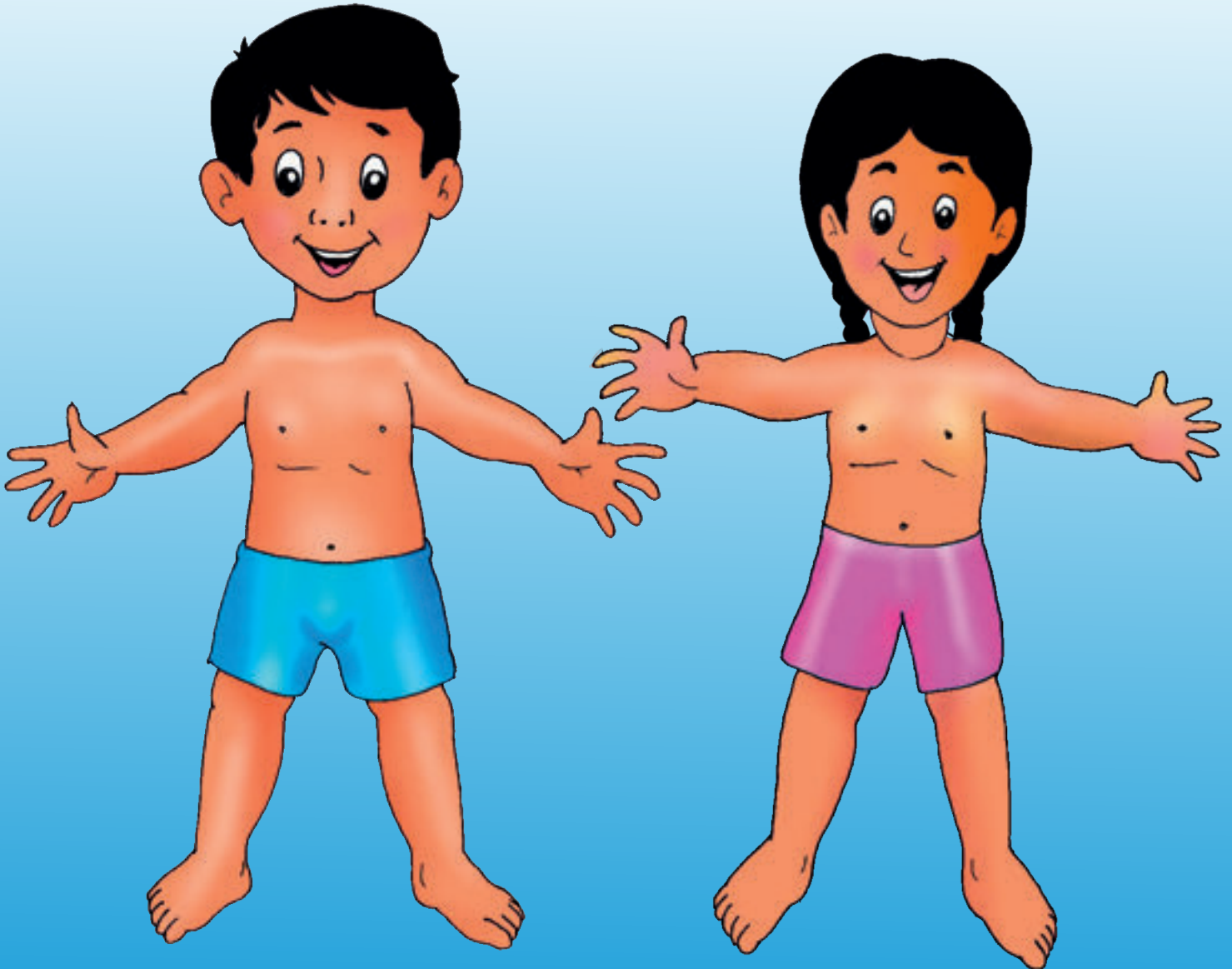

¿Kunjamaskisa k'umara kankañana janchisaxa?  
¿Kuna manq'anakasa k'umara jakasiñataki wakisispha?



## Janchisa uñt' asipxañäni



¿Kunsa yatiqapxañänixa?

Janchinakasana tarsunakapa uñt' apxañani.

## Janchisa uñt' añata aruskipapxañäni

1 ¿Kunatakisa jinchu wakisixa?

2 Jinchu ist'añatakiwa.

3 ¿Qhawqha jinchunitansa?

4 Paya jinchunitanwa.

5 ¿Kunatakisa nayra wakisixi?

6 Nayra uñjañatakiwa wakisixa.

7 ¿Qhawqha nayranitansa?

8 Paya nayranitanwa.



## 1. Maya warurt'a ist' apxañäni, kikipa warurt' añataki.



## JANCHISA UÑT' APXAÑÄNI

P'iqi kallachi qunquri kayu  
qunquri kayu. (Kuti)

Nayra jinchu laka nasa. (Kuti)

P'iqi kallachi qunquri  
kayu qunquri kayu. (Kuti)  
Nayra jinchu laka nasa. (Kuti)





## 2. Jichhaxa yatiqiri masinakampi aruskipapxañäni askipacha ist'asa.

1 ¿Qhawqha amparanitansa?

2 Paya amparanitanwa.

3 ¿Kunatakisa ampara wakisi?

4 Ampara qillqañataki wakisixa.

5 ¿Qhawqha luk'ananiitansa amparanxa?

6 Amparanxa tunka luk'ananiitanwa.



## 3. Yatichirimpi janchisatha aruskipapxañäni.

1 Yatichiri ¿qhawqha kayuniitansa?

2 Wawanaka, paya kayuniitanwa.

3 ¿Kunatakisa kayu wakisi?

4 Kayu sarnaqañatakiwa wakisixa.



**Aymarata akhama arunakampi arsuña yatiqañäni.**

Janchisana chiqanakapa: ampara, kayu, p'iqi, ...



#### 4. Jiskht'awinaka aski amuyawasina phuqachapxañäni.

¿Qhawqha nayraniitansa?



*Paya nayranitanwa.*

¿Kunatakisa **nayra** wakisi?



¿Qhawqha kayuniitansa?



¿Kunatakisa **kayu** wakisi?



#### 5. Jichhaxa arunaka amuyawasina chiqaparu uñichayañäni.

Nasa

Laka

Luk'ana

Jinchu

Nayra

Wintu

Qunquri

Kayu

Ampara



**Akiri arunakampi arsuña yatiqañäni.**

Janchisana chiqanakapa (**kayu, wintu, jinchu, laka, nasa, luk'ana, nayra, qunquri, ampara**)



# Janchinakasata arsupxañäni



¿Kunsa yatiqapxañänixa?

Janchisa suma jakañataki q'umachasiñäni.

## Janchisa q'umachasiñata aruskipapxañäni



## Jichhaxa aruskipawinaka askipacha ist'apxañäni.



Nayaxa janchijpacha jaristhxa.



Nayaxa ampara jawunampi jarisisktha.



Nayaxa laka jarisisktha.



## 1. Maya warurt'a ist'apxañäni, kikipa warurt'añataki.



### Jarisiñäni wawa masinaka

Ana imilla wawa masi.  
Lakama jaristati,  
Arturo yuqalla wawa masi  
Amparama jaristati.  
(kuti)





## 2. Yatiqiri masinakasampi aruskipapxañäni:

1 ¿Kuna pachasa laka jaristha?

2 Nayaxa, sapüruwa jaristha.

3 ¿Kunatakisa janchi jaristaxa?

4 Janchisa k'umara jakasiñatakiwa jarisiñaxa.

5 Nayaxa sapa kuti manq'awasina laka jaristha.



Laka jarisiña yänaka uñ' añäni:



## 3. Awicharu jiskht' asiñäni laka jarisiñatha.

1 Wawanaka laka jarisipxantawa.

2 Awicha ¿kunatakisa jarisiñaxa?

4 Lakaxa saruntaspawa jani jarita, ukhamarusa t'ijisiriwa.

3 ¿Kamachaspasa jani jaritaxa?

6 Sapa kuti manq'asiwasina jarisiñaxa.

5 ¿Kuna pachasa jarisiña?



**Uka arunakampi arsuña yatiqañäni.**

Laka, ampara, kayu, p'iqi jarisiñasawa.



#### 4. Jichha janchi jump'ina tuqitha yatxatañani.



Jump'ĩnataki  
kunanakasa  
luraña wakisixa.



Tatajaxa

Jali



Kullakajaxa

Jump'ĩnataki

Sarnaqi



Masijaxa

Anati



#### 5. Utamana wilamasinakamampi laka, janchi jarisiñata aruskipapxätha.

Janchiti jump'i

ukjaxa

kunaymana

usunakawa mistusi

ukatha alwa

qhara t'ijuña

wali sarnaqaña

ukhamarusa

kunaymana

anatañanaka phuqaña.

# Manq'anakatha arsupxañäni



¿Kunsa yatiqapxañänixa?

K'umarañataki manq'anaka uñt'apxañäni.

## Manq'anakatha aruskipapxañäni

2

Naya jiwra allpi  
manq'astha,  
ch'amaniñataki.

3

Awicha, jupaxa  
uwija aycha  
manq'asixa  
jilañataki.

1

Jumanaka, ¿Kuna  
manq'anaksa  
k'umarañataki  
manq'apxtaxa?

4

Jiwasaxa, puqutanaka,  
chuxña manq'anaka  
phayasipxañasa,  
k'umara jakasiñataki.



## 1. Maya warurt'a ist'apxañäni, kikipa warurt'añataki.

### MANQ' ANAKATA Arsupxañäni Añuthaya wirsu

Nayaxa akhama wakisiri  
manq'a manq'astha,  
wali ch'ullqiñataki suma  
jakañataki;  
jiwra, juchha manq'añani  
aychanaka jach'a jilsuñataki  
manq'añani,  
chawllanaka ch'ullqiñataki  
manq'apxañäni.  
jallallaphanaya  
pachamamasaxa. (kuti)





## 2. Jichhaxa aruskipawinaka wakisiri manq'anaka uñt'apxañani.



## 3. Jichhaxa jiliri jaqinakana aruskipawinakapa ist'apxañani.



Akiri arunakampi arsuña yatiqañani.

Nayaxa, jumaxa, jupaxa, jiwaxa.



#### 4. Wakisiri manq' anakatha aruskipapaxañäni.

Wila parixa



Jiwasaru jilayañataki wakisi.

Nayaru aski ch'amaníñataki wakisi.



Qañiwa jak'uxa

Jiwra juchhaxa



Jumaru ch'akanakama thurunchañataki wakisi.



#### 5. Manq' anakata yatichirimpi aruskipapaxañäni.



**Nayaxa:** qañiwa allpi, jiwra allpi ch'amaníñataki manq'astha.

**Jupanakaxa:** Apilla qhati, isañu qhati k'umarañataki manq'asipxi.



**Jumaxa:** kututu taxti jach'a jilañataki manq'ätaxa.

#### Jichha manq' anaka uñ'asa wakisiriparu irpthapipxañäni.



Jiwra juchhaxa

ch'amaníñataki



Wila parixa

k'umarañataki



Qarachi wallaqixa

jilañataki



Qañiwa jak'uxa

ch'ikiñataki

# Jani usuntañataki isthapisipxañäni



¿Kunsa yatiqapxañänixa?

Suma thuru isinakampi isisiña jani usuntañataki.

## Jani usuntañataki isthapisinãata aruskipapxañäni



1. Maya warur' a ist' apxañäni, kikipa warur' añataki.



**Suma isini wawawanaka**

Wilma kullakaxa suma isiniwa  
Pullirani, mantunani,  
ukhama sumawa

Kusi jilataxa suma isiniwa,  
Ch'ulluni, chalani, ukhamawa.

Taqini suma isthapisipxañäni,  
Punchuni, ch'ulluni, ukhama.  
Taqini suma isthapisipxañäni,  
Janiwa kuna ususa katjchitaniti.



## 2. Jichhasti, jamuqanakana arsutanakapa amuyapxañäni.

1 Thayjituwa yatichiri tata.

3 ¿Janiti jumaru thayjtamxa?



2 Mantunampi thapintasma.

4 Nayaxa lankhu kasakanithwa



1 Ch'ulljasismaya yatichiri tata.

3 Kullakajawa ch'ullu p'itaskixa.



2 Ch'ullu alasiña muntha.

4 Nayataki maya ch'ullu p'itarapitphana.



## 3. Paninkama uka lurawinakatha arsuqipapxañäni.

1 ¿Nayaxa kuna isinakanithsa?.

4 Awayu, juwanilla, sumpiru, ....



2 Ch'ulluni, chalikuni, kamisani, ...

3 ¿Nayana isinakajasti?



**Akiri arunakampi arsuña yatiqañäni.**

Kunjama isinakanithansa: ch'ullu, chala, sumpiru, ...





#### 4. Jani usuntañataki istaphisipxañäni.



Chalaxa



Punchuxa



Ch'ulluxa



Chusixa

Khititaki

Kunatakisa

Chachataki

Ikiñana jisqhasiñatakiwa

Kunka jani thayjayasiñataki.

Warmitaki

Thayatha jark'iriwa.

Misa qalaru jant'akuñataki.

Phunchawina ist'asiñataki.

P'iqi junt'uchañapataki.



#### 5. Utana awkisampi, taykasampi chika isinaka uñ'apxañäni.



pullira

allmilla

ch'ullu

awayu

punchu

pantalu



**Akiri arunakampi arsuña yatiqañäni.**

Pullira, allmilla, ch'ullu, awayu, punchu, pantalu.



¿Kunsa yatiqapxañänixa?

Qullasiri saririna usuntatapatha aruskipaña.

**Jani usuntañataki aruskipapxañäni**

1

¿Ana kullakaruxa  
kuna ususa  
katpacha?

2

Ch'uxu usu  
katpacha.

3

¿Janiti **COVID**  
usukpacha?

6

Anaru qulluri  
sarañäni.

4

¿Anaru  
qullapxañaniti?

5

¿Kunjamsa  
qullapxsnaxa?



**1. Maya warur' a ist' apxañäni, kikipa warur' añataki.**



**QULLASIPXAÑÄNI**

Achuqallu - wirsu

Jani usuntañataki  
qullasipxañasawa. (Kuti)

Qura qullanakampi  
thaya qullanakampi  
junt'u qullanakampi  
K'umara jakañataki. (kuti)





## 2. Kuna usunakasa utji, ukanakatha aruskipapxañäni.



Phuti usu

Jurma usu

Ch'uxu usu

**COVID** usu



## 3. Wawanakaxa Anana usutapatha yatxatapxi.



**2** Anaxa usutawa jikxatasi.

**1** ¿Kunatsa Anaxa jani Yatiña Utaru jutixa?

**3** ¿Kuna ususa Anaru katutaxa?

**4** **COVID** usuwa katutaxa.

**6** ¿Kunjamsa qullapxsnaxa?

**5** ¿**COVID** usuti katutayna?



**Akiri arunakampi arsuña yatiqañäni.**

**COVID** usu, phuti usu, ch'uxu usu, jurma usu, ...



#### 4. Qulliri mamaxa qullanakana wakisiriphata yatichistani.

Phuti usu

Jurma usu

Ch'uxu usu

COVID usu



**Phuti** usu qullañatakixa ayrampu, linasa, tilu umañaxa.

**Jurma** usu qullañatakixa yukalitu llaqawa umañaxa.

**Ch'uxu** usutakixa wanquyru misk'iwa umañaxa.

**COVID** usu qullasiñataki yukalitu, kiyuna, ajusa, matiku umañaxa.



#### 5. Qullasiri mamampi qullanaka tuqita aruskipapxañäni.



Magaly

1 ¿Kuna qullasa wakisi ch'uxu usu qullañatakixa?

3 ¿Kuna qullasa wakisi jurma usu qullañataki?

4 ¿Kuna qullasa wakisi phuti usu qullañataki?

5 ¿Kuna qullasa wakisi **COVID** usu qullañataki?



Marcos

2 Wanquyru misk'i umañamawa. Yukalitu llaqa umañamawa.



Qulliri mama

6 **COVID** usu qullasiñataki yukalitu, kiyuna, ajusa, matiku, ukanakawa wakisixa.



**Akiri arunakampi arsuña yatiqañäni.**

Usunaka qullasiñxata jurma usu, phuti usu, COVID usu.

# Qullayasiri saririna usuntatapata aruskipapxañäni



¿Kunsa yatiqapxañänixa?

Qullaña utana qullasiña tuqita aruskipaña.

## Qullaña utana qullasiñata aruskipapxañäni



1. Maya warur' a aruskipapxañäni, kikipa warur' añataki.



### QULLAÑA UTA

Q'ajelo - naya chacha wirsu

Taqi jiwasanakawa uñjayasiri saraña  
Qullaña utaru sarañasawa  
Jani usuntañataki,  
Jani usuntañataki. (kuti)

Kunaymana usuta jark'asiñataki  
k'umara jakasiñataki,  
jani usuntañataki,  
jani usuntañataki. (kuti)



Akhama arunakampi arsuña yatiqañäni.

Kunaymana usuta jark'asiña, qullasiña.



## 2. Qulliri tatampi aruskipapxañani.



1 Qulliri tata,  
¿Kunathsa p'iqixa  
ususi?



2 ¿Kunampisa  
puraka k'ichi  
qullasiñaxa?



3 ¿Kunathsa  
**COVID** usu  
churasi?



4 Janchinakama  
aski uñakipañawa.  
Ukhamaruwa qulla  
churapxamama.



## 3. Juk'ampi ist'apxañani.



1 Purakawa  
k'ichitu, qullaña  
uta nayaxa  
saraña.



2 Nayampi qullaña  
uta sarañani

4 Llukuntasitawa  
qullana utaru  
saraña sapxiwa.

3 Khäya markankiwa  
qullaña utaxa.



5 Ukhamaskapuniwa  
**COVID** usuta  
jark'aqasiñataki.



#### 4. Akiri arunaka aski amuyawsina irpthapiñäni.

Anaxa usutawa

Awichampi  
aruskipaspha.

Kusixa waliptxiwa

Qullaña uta  
sarañaapawa.

Marinaxa k'uchiskiwa

Utaparu  
sarxañaapawa.

Willmaxa llakitawa

Phuqata  
luraskañaapawa.



#### 5. Jichaxa qullirjama utana jiwaxa yanasipxañäni.

1 Nayaxa qulliri  
tatäthwa,  
ékunamasa  
ustama?

2 Nayaxa jayapacha  
usutäthwa,  
chuymawa usutu.

3 Aka makinampi  
uñantamama,  
janiwa sinti  
usutäktati.

4 Qullt'akitaya,  
mirä suma  
qulliri tata.



#### Akhama arunakampi arsuña yatiquañäni.



Usuta**wa**, qullaña**wa**, k'uchiski**wa**, llakitawa**wa**, ...

# Yatiqatasa uñacht'ayapxañäni



## ¿Kunjamsa yatiqatasa uñacht'ayapxañänixa?

Yatiqatasa sapa mayni amtapxañäni, ukata akhama  sich'impi sich'intapxañäni.

Kunanaksa yatiqatatxa uka uñakipaja	Janirawa yatiqkti 	Yatiqawtha 
1. Janchinakasana tarsunakapa uñt'apxañäni.		
2. K'umarañataki manq'anaka uñt'apxañäni.		
3. Janchisa q'umachasiña suma jakañataki.		
4. Suma thuru isinakampi isisiña jani usuntañataki.		
5. Qullasiri saririna usuntatapatha aruskipaña.		
6. Qullaña utana qullasiña tuqita aruskipaña.		



## Kunsa uñt'apxañäni?

COVID usuta jark'aqasiñataki lluku lurapxañäni

### LLUKU- COVID 19



## 1. ¿Kuna yänakasa wakisi lluku lurañatakixa?

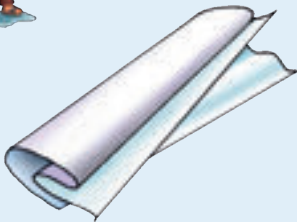

wayita



T'ipaña

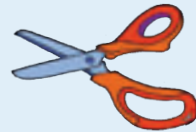

khuchuña

Ch'ankha



chiqachaña



k'ili qillqaña



Khuchkachir

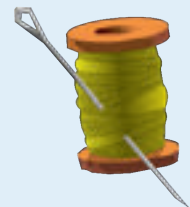

yawri





## 2. ¿Kunjamsa lluku lurapxañäni COVID usuta jark'aqasiñataki?

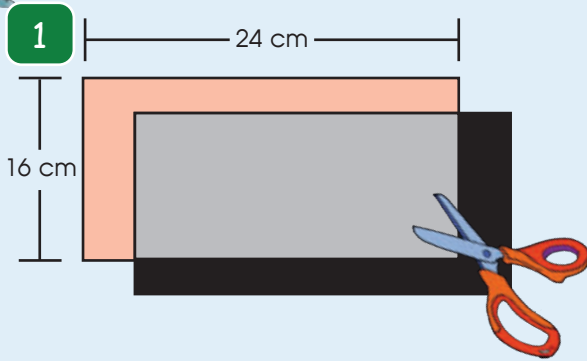

Wayita pä sayt'u wiskhalla khuchjañäni.

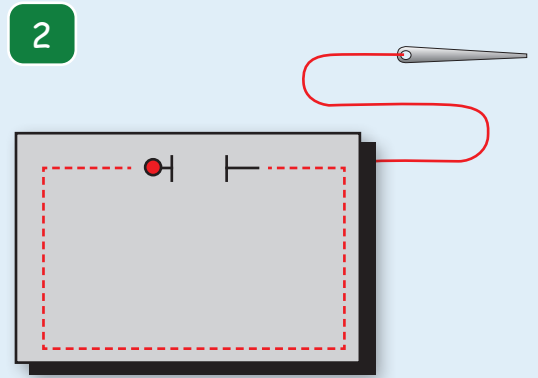

Wayitana qawayanakapa ch'ankampi ch'ukthapiñäni.

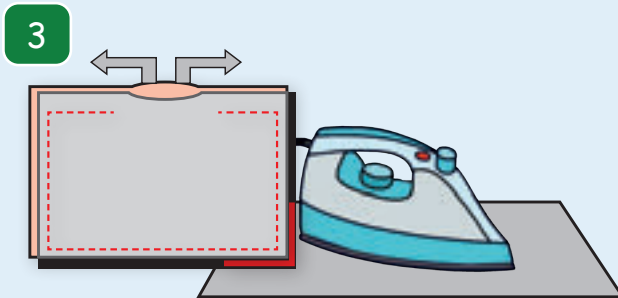

Khuchkachirimpi lluku ch'ukuta sip'unakapa chiqachañäni.

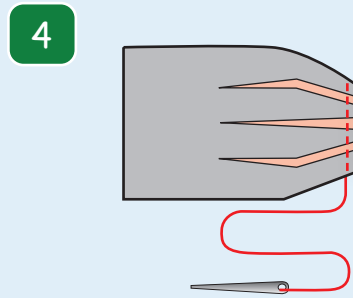

Llukuna qawayapana sip'unakapa ch'ukthapiñäni.

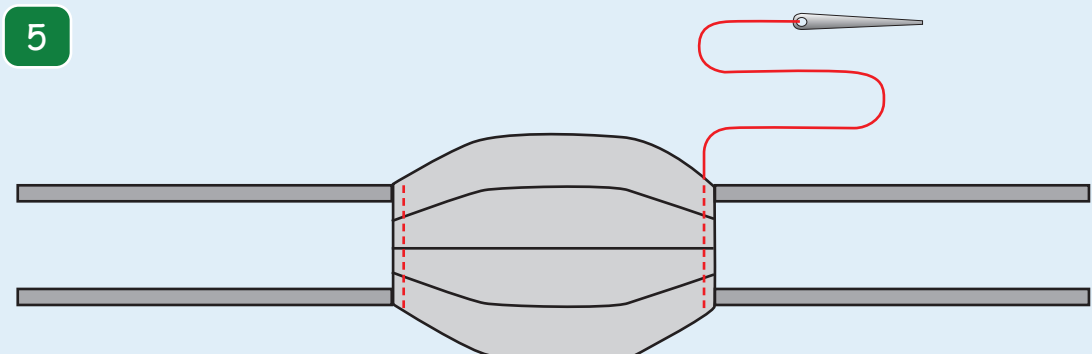

Llukuna qawayaparu ch'ukkatañäni ajuñapa jinchuru uchasiñataki.

### 3. ¿Kunjamsa uka luratasampi aruskipaxañani?

\* Nayraqataxa sawuta isi lurinakjamawa amuyapxañani.

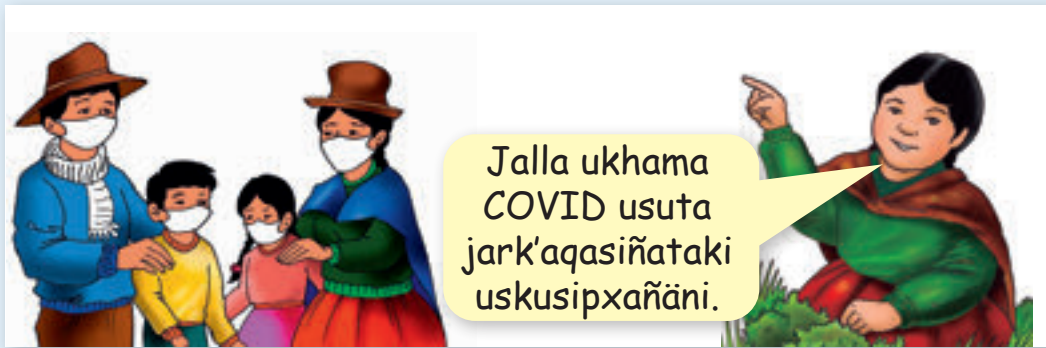

\* Panini paniniwa luratasatha aruskipapxañani.

1 Wayita paya sayt'u wiskhallaru khuchjaña.

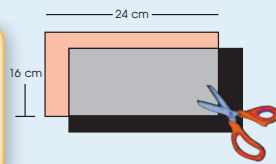

2 Wayitana qawayanakapa ch'ankampi ch'ukthapiña.

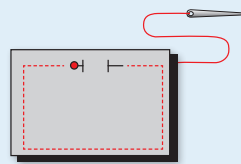

3 Khuchkachirimpi lluku ch'ukuta sip'unakapa chiqachaña.

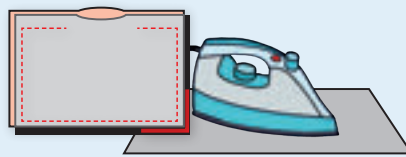

4 Llukuna qawayapana sip'unakapa ch'ukthapiña.

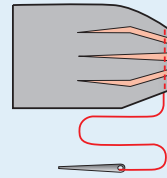

5 Llukumpi uchasa aruskipaña jani usumpi katuyasiñataki.

5 Llukuña qawayaparu ch'ukkataña ajuñapa jinchuru uchasiñataki.

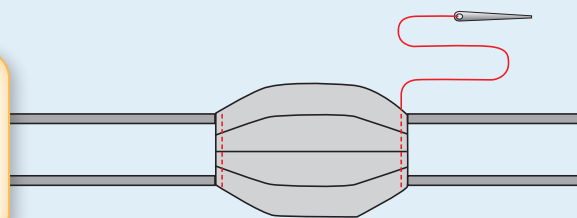

4

T'AQA

# Yatiqatasatha aruskipapxañäni



¿kunanaksa yatiña utana yatiqapxtanxa?  
¿Kunanakasa yatiña utana yatiqaña wakisiphaxa?

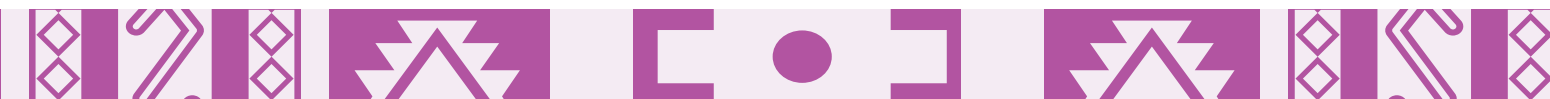

# Yatiña utana kunaymana lurañanaka



¿Kunsa yatiqapxañanixa?

Yatiña utana aymara arsuña yatiqapxañani.

Wawanaka aruskipapxma ¿kunsa yatiña utana lurapxäta?



1. Maya warurt'a ist'apxañani, ukatha ukhampacha warurt'apxañani.

## YATIÑA UTA LURAÑA

### Tinintinakana - Wirsupa



Kunsa yatiña utanxa  
jumanakaxa  
lurapxta. (kuti)

Näyaxa yatiqtxa  
mä jarawi ullaña (kuti)

Ukhamawa nayaxa  
jumaxa kunaraki luraskta. (kuti)



Akhama arunakampi arsuña yatiqañani.

Naya, juma, jupa, nayaxa, jumaxa, jupaxa.



## 2. Yatichirimpi warurt'a ist'awasina aruskipapxañäni.

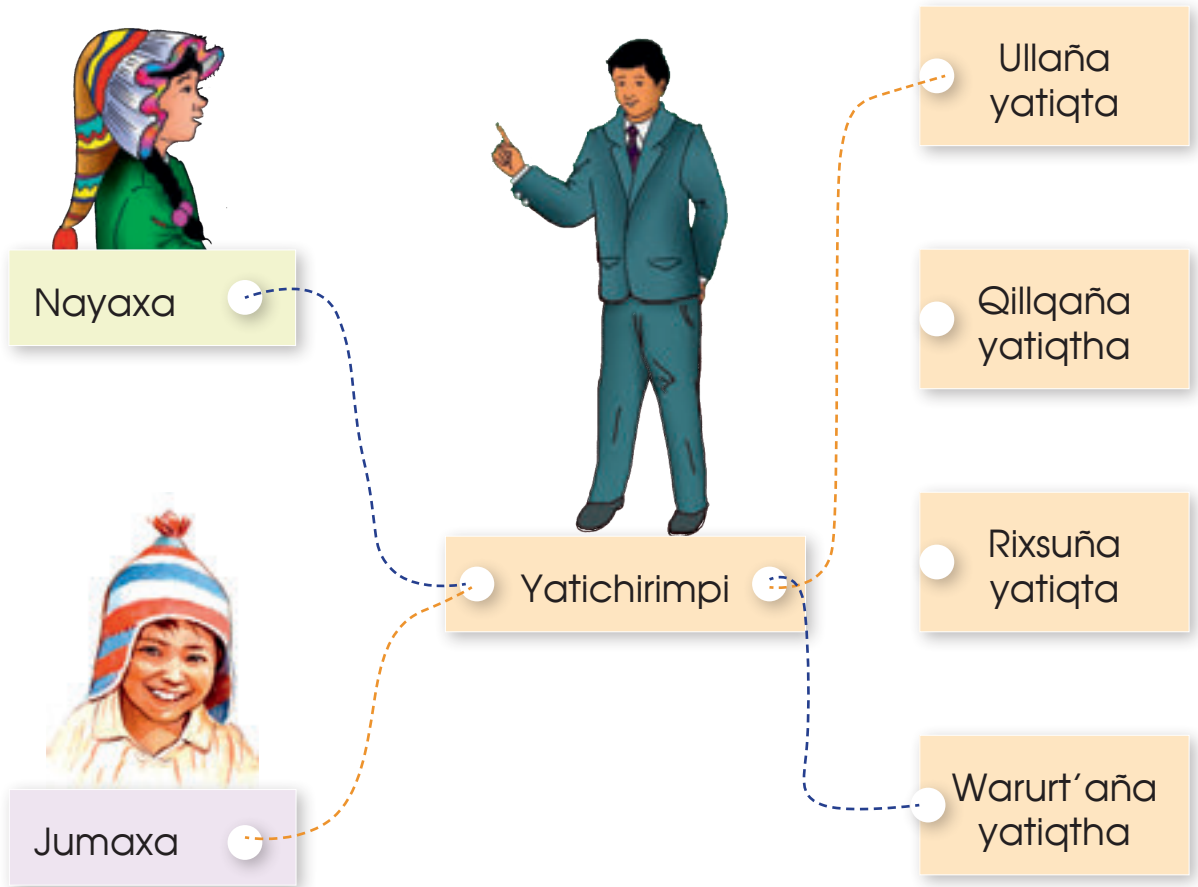

## 3. Jichhaxa aruskipapxañäni kunanaksa yatiqaña utana lurapxthana.

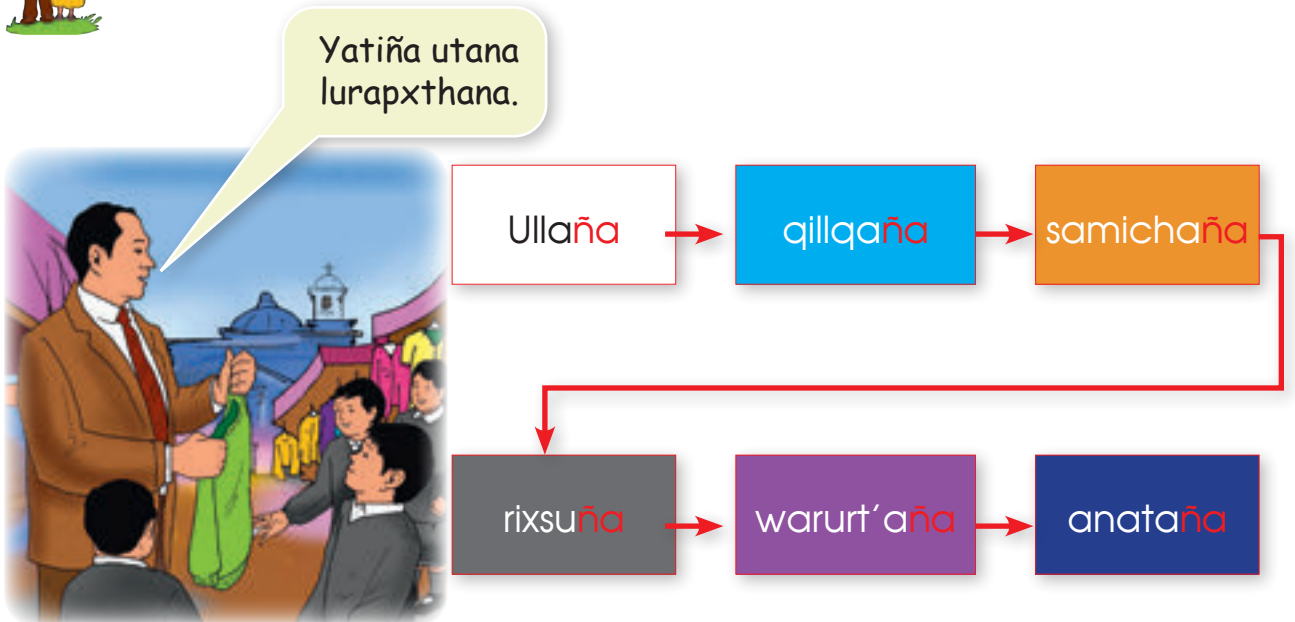



#### 4. Sapa jamuqa uñxatawäsina sutipampi jakisiyma.



Qillqaña



Ullaña



Phiskhuña



Samichaña



Rixiña



Anataña



#### 5. Utasana awkinakasampi, jilanakasampi yatiqaña utana lurañanaka tuqitha aruskipapxañäni.

1 ¿Kunanaksa wawanaka yatiqanipxtha?

5 Nayaxa ullaña.

2 Nanakaxa warurt'aña.

4 ¿Jumasti wawä?

3 Nanakaxa qillqaña.



#### Yatiqatasa jani armañataki.



Nayaxa

Jumaxa

Jupaxa

# Yatiqaña utasana lurawinakapa aruskipapxañäni



## ¿Kunsa yatiqapxañänixa?

Jiwaspurawa yatxatapxañäni mayt'asiña yatxatapxañäni.

## Wawanaka aruskipapxma ¿Kunjamsa yanapt'asipxsnaxa?



### 1. Arsutanaka aski ist'awasina aruskipapxañäni.

Jumanakkama mayt'asipxma  
 Jilata mayt'itha,  
 Iyawa jilata mayt'amamalla,  
 Nayaxa kunsa mayt'amama  
 Paysuma jilata, kullaka.





## 2. Yatiqiri masinakasampi mayt'asiñxata aruskipapxañäni.

### Jiskht'awinaka ullawasina wakisiripa jakipxañäni

¿Kunanaksa  
jiwaskama  
mayt'asipxsnaxa?



Phiskuña

Qillqañataki

Lapisa

Jamuqanaka  
samichañataki

Lapisa  
saminaka

Qillqatanaka  
phiskuqañataki.

Chiqachiri

Muxsa  
alasiñataki

Qullqi

Siqinaka  
rijinataki



## 3. Suma arunaka jiskht'awasina wakisiripa jakipxañäni.

¿Kunaksa  
jiwaskama  
mayt'asipxsnaxa?



Mirä suma

Wasitampi  
yatichitaya.

Jani ukhamamti

Chiqachirima  
mayt'ita.

Suma Jilata

Qullqi mayt'ita.

Suma Kullaka

Lapisama  
mayt'ita.













Yatichiri tata

Samichañama  
mayt'akitalla.





4. Jamuqanaka uñxatawasina, uñt'apxañani sapa ukhamaraki waljanaka, ukatha jakhupa samichañani.

Sapa	Waljanaka
 <b>Lapisa</b> ○ ○ ○ ○ ○	 <b>Lapisanaka</b> ○ ○ ○ ○ ○
 <b>panka</b> ○ ○ ○ ○ ○	 <b>pankanaka</b> ○ ○ ○ ○ ○
 <b>chiqachiri</b> ○ ○ ○ ○ ○	 <b>chiqachirinaka</b> ○ ○ ○ ○ ○
 <b>phiskhuña</b> ○ ○ ○ ○ ○	 <b>phiskhuñanaka</b> ○ ○ ○ ○ ○
 <b>samichaña</b> ○ ○ ○ ○ ○	 <b>samichañanaka</b> ○ ○ ○ ○ ○
 <b>Laphi</b> ○ ○ ○ ○ ○	 <b>Laphinaka</b> ○ ○ ○ ○ ○



5. Utasana jakhusa aruskipapxañani.

# Yatiqawi yänakatha aruskipapxañäni



¿Kunsa yatiqapxañänixa?

Yatiña utana kunaymana lurañanaka.



1. Maya warurt'a ist'apxañäni, ukatha ukhampacha warurt'apxañäni.

**YATIQIRI MASIJA.**

(Siku phusirinakaru uñtatawa)

Jaltanma, jaltanma k'ataki

Yatiqiri, yatichirisawa purintani. (kuti).

Jichha uruwa ullañani

Jichha uruwa qillqañani. (kuti).

Yatiqiri, masija, ch'amt'asisa

Jichha uruwa ullañani. (kuti).





## 2. Jichhaxa yatichirisampi markapata aruskipaxañäni.

### Yatichiriru jaysapxañäni

1 Yatichiri ¿Kawkitsa purintaxa?

2 Nayaxa markajatha purintha.

3 Yatichiri ¿kuna sutinisa markamaxa?

4 Markajaxa Juliaca satawa.

5 Yatichiri ¿kunjamasa markamaxa?

6 Wali jach'a markawa.



## 3. Qutuchasisinxaxa, yatichirina markapa tuqitha jiskht'apxañäni. Ukata maya ( X ) sich' intapxañäni.

¿Kunasa uka marka utjpacha?

utanaka	awtunaka
jichhunaka	
uywanaka	allphachunaka

¿Kuna uywanakasa utjpacha?

uwija	asnu
waka	
wallpa	qamaqi



¿Kuna sutinisa markapaxa?

Puno	Axura
Juliaca	
Lima	Juli

¿Kuna manq'anakasa utjpacha?

Chawlla wallaqi	phiri
puqutanaka	
T'awra	Isañu thaxthi



#### 4. Jiwaskama aruskipapxañäni, kunjama ist'atasa yatichirisaxa jutatayna.

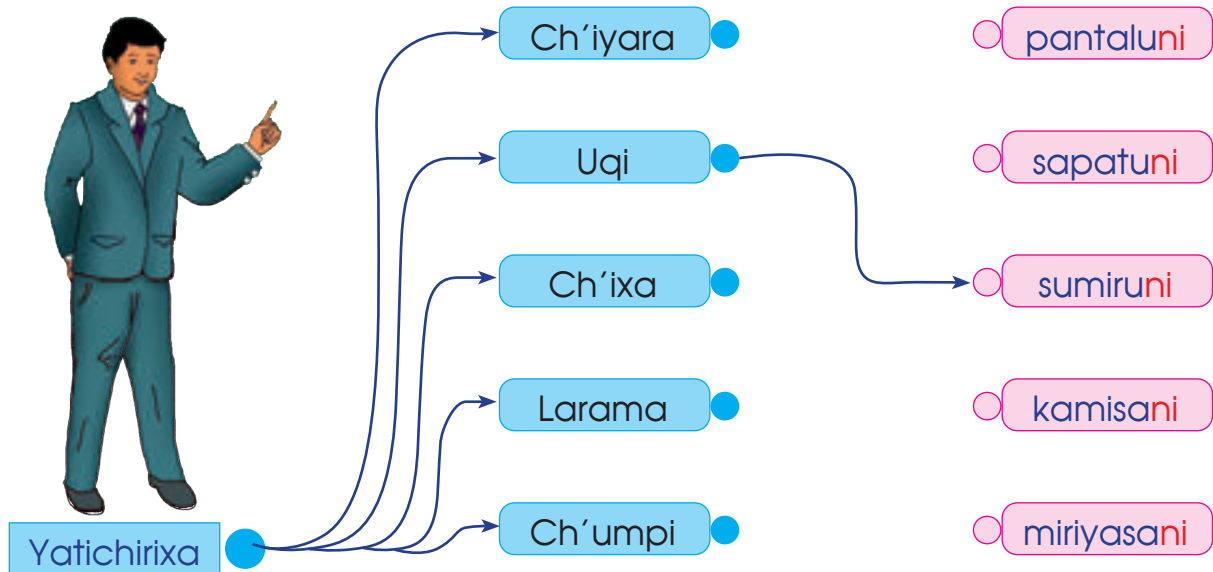

#### 5. Panicht'asisa utana, yatichirina isipa tuqitha aruskipapxañäni.

- ¿Kuna saminisa kamisapaxa?
- Kamisapaxa ch'umpiwa
- ¿Kuna saminisa sumirupaxa?
- Sumirupaxa uqiwa.
- ¿Kuna saminisa sapatupaxa?
- Sapatupaxa ch'irayawa.



**Akhama arunakampi arsuña yatiqapxañäni.**  
¿Kuna saminisa yatichirina isinakapaxa?

# Yatiqañataki yänakatha aruskipapxañäni



## ¿Kunsa yatiqapxañänixa?

Aymara arusata uñt'apxañäni yatiqaña yänaka.

1

Kunaymana yänaka apnaqaña yatiqapxañäni.

2

Jiwaskamasa sasiraksnawa.

4

Akaxa tawlita satawa.

3

Akaxa qillqañataki, ullañatakiwa.



## 1. Maya warur' a ist'apxañäni, ukatha ukhampacha warur'apxañäni.



**Yatiqañäni yänakampi**  
 (Satiri - wirsu)

Yatiqaña yänaka apnaqapxañäni  
 Ulläña, qillqaña yatiqapxañäni. (kuti)  
 Kumputaruranaka apnaqapxañäni  
 Suma tawlitanaka apnaqapxañäni. (kuti)  
 Kunaymana yänaka apnaqapxañäni  
 Wali k'uchisisa apnaqapxañäni.  
 La, la, la, la, la, la la. (kuti)



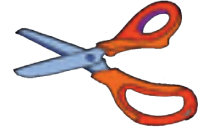

## 2. Jichhaxa yänakatha aruskipapxañäni.



## 3. Qutuchasiwsinxaxa, yänaka tuqitha aruskipapxañäni.

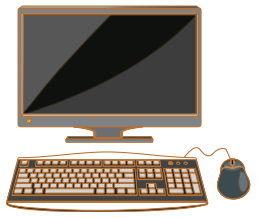

Kumputarura



Lip'iyaña



Tawlita

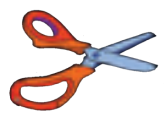

Khuchuña

Lip'iyañataki

khuchhuñataki

qillqañataki

wakisixa

ullañataki

jamuqañataki



#### 4. Yaqha masisampi aruskipañäni sutilantinakampi yänaka apnaqaña irpthapiñäni.

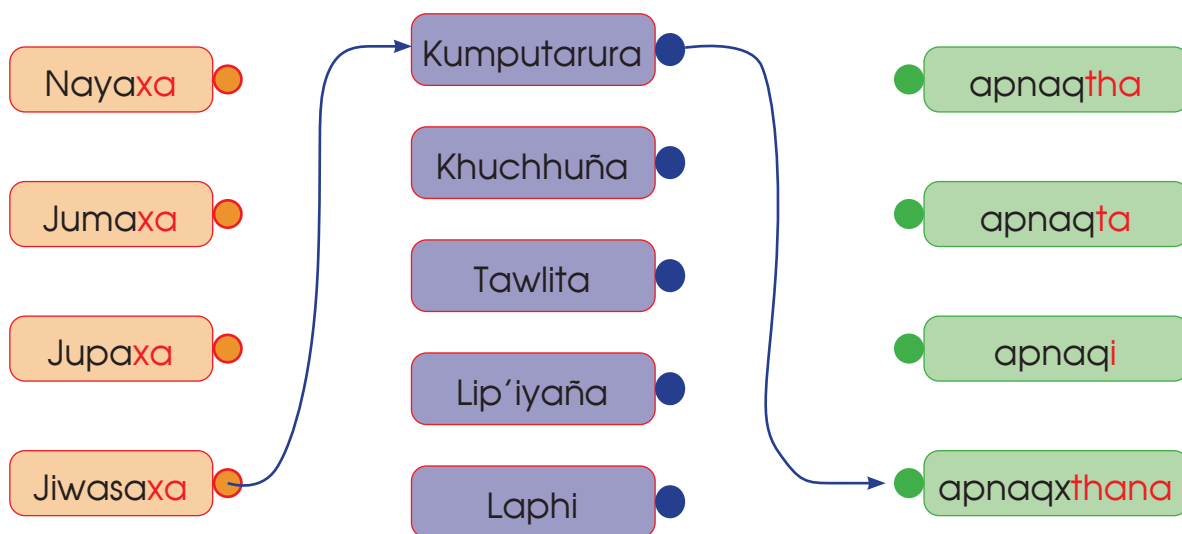

#### 5. Jichhaxa yänaka katjäsina wakisirinaka arsupxañäni.



# Yatiqiri masinakasampi yanapt'asipxañäni



¿Kunsa yatiqapxañänixa?

Aruskipasisa yänaka mayt'asiña ch'amañchasiñani.

**Wawanaka jumanakkama yanapt'asipxma.**



1 Akaxa jakhunaka phuqachañawa.

2 ¿Kunjamasa uka lurañaxa yaticht'ita?

3 Nayaxa luraña munarakthwa.

4 Taqini yatiqañataki yanapt'asipxañani.



1. Maya jarawi ist'apxañäni, ukatha ukhampacha jarawt'apxañäni.



## Yanapt'asipxañani

Taqinisa yanapt'asipxañäni,  
Ullana, qillqaña yanapt'asipxañäni.  
Wawa masijanajakampi  
Munata yatichirijampi  
Taqinisa yanapt'asipxañäni.  
Kumputarura tawlita apnaqañataki  
Jiwasa wali yatiqañataki.







## 2. Suma arunaka arsuña jakisiyasa yatiqapxañäni.

Mirä suma

Jilata yanapt'kirisa.

Jani ukhamamti

Jilata yanapt'italla.

Mirä quli

Jilata yanapt'asitha.

Paysuma

Jilata yanapt'asitalla.



## 3. Jichhaxa panini panini aruskipapxañäni.

1 Jumaxa ékunsaxa  
yaticht'itasmamaxa?

2 Nayaxa kumputarura  
apnaqaña  
yanapt'kirismamaxa.

4 Nayaxa, tawlita  
apnaqaña  
yatichiriksmamaxa.

3 Juma,  
ékunanaksa  
yaticht'itasma?

5 Ukhamaxa  
yanapt'asiñani.

6 Iyawa, taqinisa  
yanapt'asiñani  
jiwaspura.



**Lurañanaka akhama arunakampi yatiqañäni.**

Mirä suma, Jani ukhamanti, Paysuma.



#### 4. Qutuchasiñxa, yanapt'asiña tuqitha aruskipapxañäni.

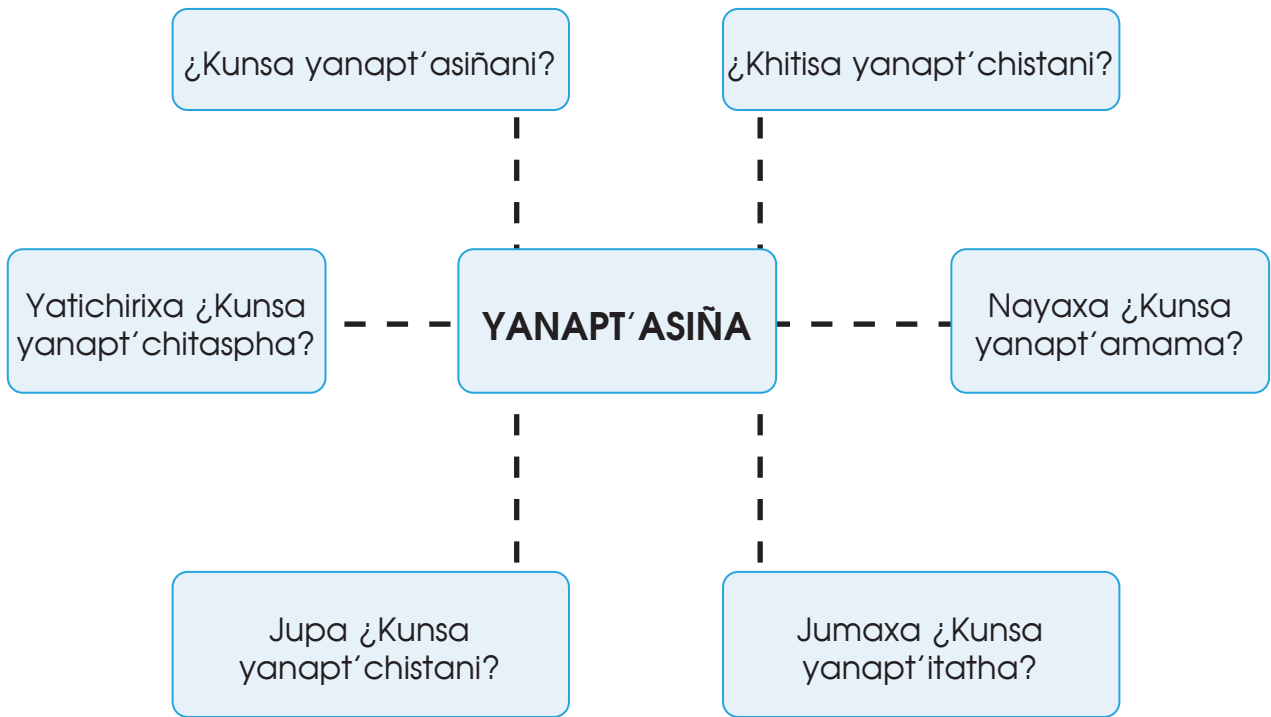

#### 5. Jiwaspura aruskipañani utana, kuna yanapt'asiñanaksa yatiqawapxtanxa.

Yatiqawapxtanwa

- kumputarura
- Tawlita
- panka
- laphiru
- jamuqanaka

- apnaqaña
- ullaña
- apnaqaña
- samichaña
- qillqaña



**Akhama arunakampi arsuña yatiqañäni.**

**Yänaka apnaqaña, mayt'asiña.**



### ¿Kunsa yatiqapxañänixa?

Yatiña utana kunaymana lurañanaka.



### 1. Maya jarawi ist'apxañäni, ukatha ukhampacha jarawt'apxañäni.



#### YATIQAÑA UTASA (Jarawi)

Jichha maraxa,  
Yatiña utaruxa,  
Suma yatichirinakawa purinipxi.  
Wali munasiña chuymankama.  
Yatiqaña utasaru jutapxañäni  
Ullaña qillqaña, yatiqapxañäni  
Anatasisa yatiqapxañäni  
Kunaymana saminaka samichaña  
Yatichirinakampi,  
Suma yatiqapxañäni.





2. Jichhaxa yatichirisampi saminaka uñt'apxañäni.



3. Qutuchasisinxä, yatiqiri masinakasampi kunjama saminisa yatiquaña utasa ukata aruskipapxañäni.

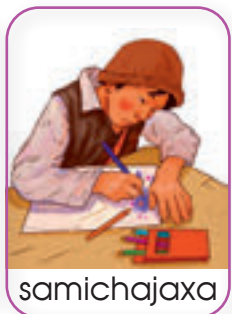
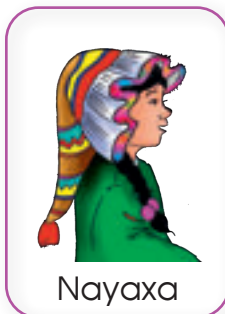



#### 4. Panini panini, saminaka tuqitha aruskipapxañäni.



**¿Khithisa yatiqaña utapa samichixa?**

 Yuqalla	 Imilla	 Yatichiri
--	---	--



#### 5. Panicht' asisa utana, saminaka tuqitha aruskipapxañäni.



- 1 ¿Kuna saminisa utamaxa?
- 2 Utajaxa sajuna samimpi samichatawa.
- 3 ¿Kuna saminaksa uñt'awtaxa?
- 4 Walja saminakwa uñt'awtxa.
- 5 ¿Kuna saminisa Yatiqaña utamaxa?
- 6 Yatiqaña utajaxa larama sajunampi, janq'umpi samichatawa.





**Akhama arunakampi arsuña yatiqañäni.**  
Ch'iyara, janq'u, larama, chupika, q'illu, ch'uxña,  
...

# Yatiqatasa uñacht'ayapxañänixa



## ¿Kunjamsa yatiqatasa uñacht'ayapxañänixa?

Yatiqatasa sapa mayni amtapxañäni, ukata akhama  sich'impi sich'intapxañäni.

Kunanaksa yatiqatatxa uka uñakipaja	Janirawa yatiqkti 	Yatiqawtha 
1. Janchinakasana tarsunakapa uñt'apxañäni.		
2. K'umarañataki manq'anaka uñt'apxañäni.		
2. Janchisa q'umachasiña suma jakañataki.		
3. Suma thuru isinakampi isisiña jani usuntañataki.		
4. Qullasiri saririna usuntatapatha aruskipaña.		
6. Qullaña utana qullasiña tuqita aruskipaña.		

## ¿Kunsa lurapxañänixa?

Tawlitatampi jamuqanaka apsuwasina mä warur'a qillqaña yatiqapxañäni.



### Tawlita Apañaqaña

1. ¿Kuna yänakasa wakisi mä warur'a qillqañataki?

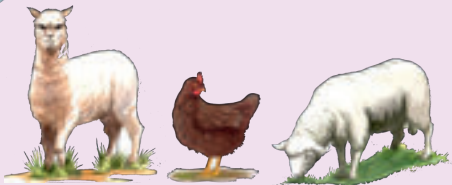

Uywanaka



Tawlita



Muxsa puqutanaka



## 2. Tawlita apnaqaña yatiqapxañäni.

Naya  
katjawxthwa  
jamuqsuñataki



## 3. Nayraqata tawlitampi jamuqanaka apsupxañani uywanakaru, muxsa achunakaru, yänaka warurt'anaka qillqañataki.

Nayaxa mä  
uywa jamuqapa  
apsujaxa.

Nayasti ékuna  
jamuqaraki  
apsujasti?



Nayaxa mä  
muxsa achuruwa  
jamuqapa apstha.

Nayaxa mä  
uywana jamuqapa  
apstha warurt'a  
qillqsuñataki.





#### 4. Uywaru jamuqatanakampi mä warut'a qillqsupxañäni.

### Uywanakaru

#### (Pampa kusi kusi - Wirsu)

Allpachuskiriktha juqunkaskirikthwa  
Munirija jutaspha t'ijtawxiriktha. (kuti)

Wisk'achaskiriktha jaqinkaskirikthwa  
Munirija jutaspha khuych'ukt'iriktha. (kuti)

Pampa kusi kusi kusiskarikisma  
jamuqama uñkatasa kusiskarakisma. (Kuti)



#### 5. Muxsa puquta jamuqatanakampi mä warut'a qillqsupxañäni.

### Achuna saminakapa

#### (Balscrito - Wirsu)

Pachamamasaxa uywasituwa  
Taqinisarurakiwa.

Quqanakaru, uywanakaru, jaqinakarawa.

Jichhasti muxsa achuna saminakapa  
uñt'apxañani Mansanana samipasti, chupikampi  
janq'umpiwa

Larankha samipasti larankha, churi q'illuwa  
Latanuna samipasti q'illu q'illurakiwa. (kuti)





5

T'AQA

# Marka qhatu uñjiri sarapxañäni

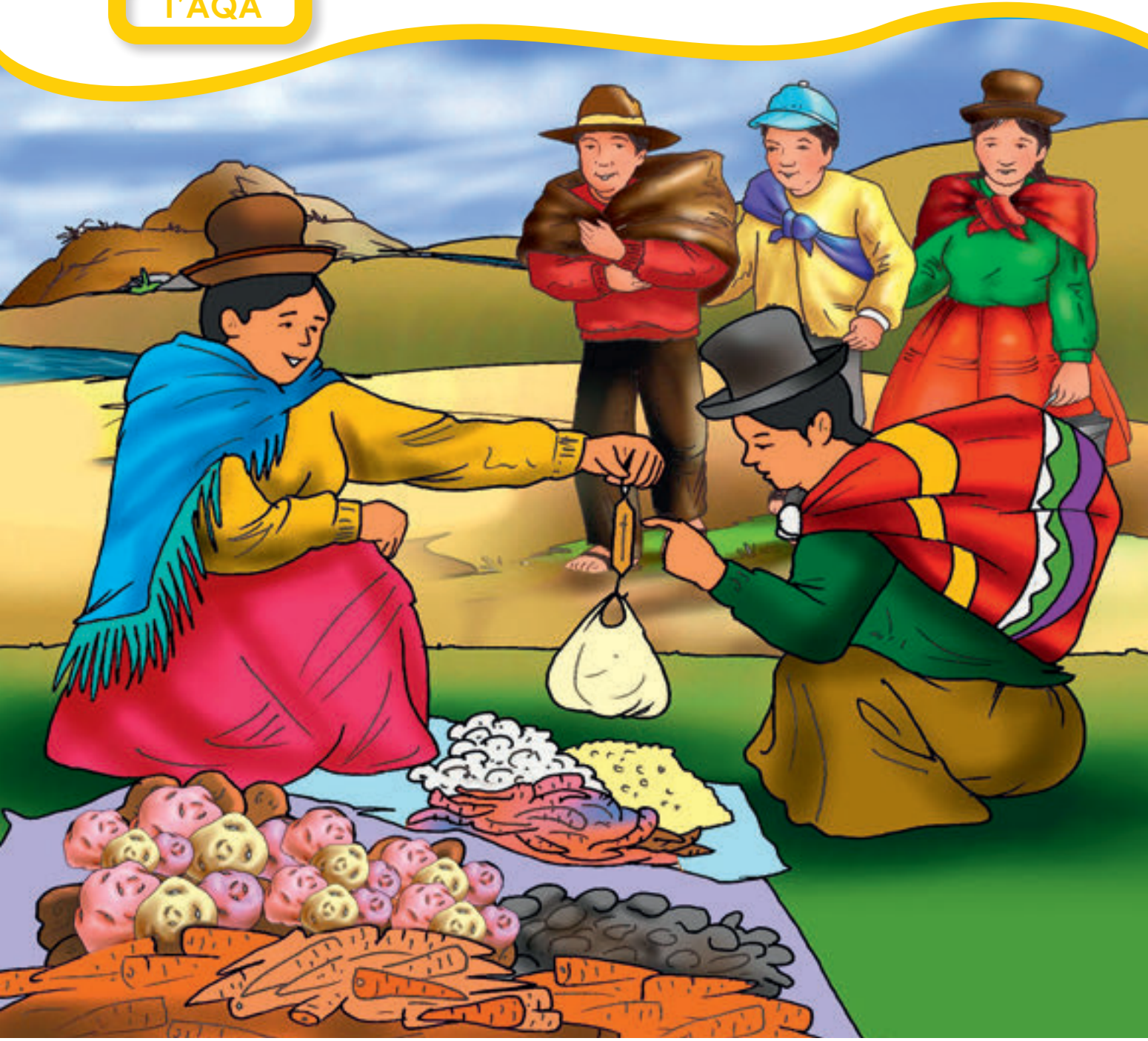

¿Kamsasa qhatuna aruskipasippachaxa?  
¿Wakisisphati alañana, alxañana aruskipañaxa?



# Qhaturu achunaka, apapxañäni alxañataki

Uñt' apxañäni kuna achunaksa alxaña apapxi.



¿Kunsa yatiqapxañäni?

Qhatuna achunaka alxaña alasiñataki yatiqapxañäni.

1 ¿Kuna achunaksa qhaturu alxañataki apaniptaxa?

4 ¿Kunanaksa apaniptaxa Alxawapxita?



3 Nayaxa apasintwa ch'uñu, tunta, ch'uqi, jiwra, yarana.

2 Nayaxa apasintwa kisu, ñuxñu, aycha, k'awna.



1. Maya warurt'a ist' apxañani, ukatha kikipa warurt' apxañäni.

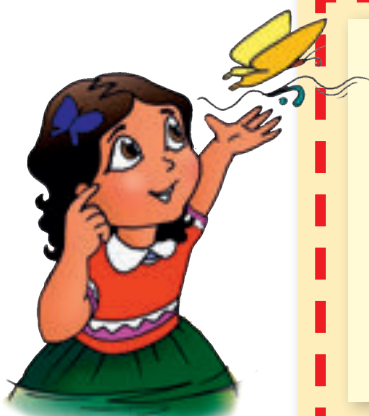

## Manqanaka alxaña

(Wilamasi: wirsu)

Alasita alasita kullaka  
Kunsa apanta kunsa apanta  
Alxita, alxita.

Nayaxa apantwa nayaxa apantwa,  
Manq'añanaka manq'añanaka,  
kullaka, jilata, kullaka, jilata.



Akhama arunakampi arsuña yatiqañäni.

Manq'añanaka alasita, alxita, ...



## 2. Manq' anakana sutinakapa thaqhapxañäni.

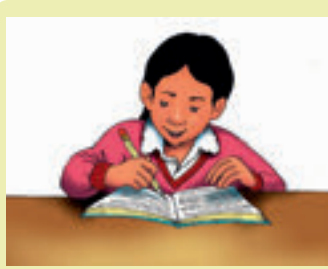

1. CH'UQI
2. K'AWNA
3. KISU
4. CH'UÑU
5. JIWRA
6. TUNTA
7. ÑUXÑU
8. AYCHA
9. YARANA
10. ALXAÑA

P	CH'	U	Q	I	W	R	J	X	S	A	K'
I	D	T	S	I	R	I	X	J	H	Y	A
X	S	A	N	W	A	K'	S	H	U	C	Y
Q	K	W	R	S	X	Q'	U	U	Y	Y	C
N	I	R	I	Y	S	A	I	R	A	H	H
M	S	C	H'	U	Ñ	U	X	I	R	A	A
R	U	S	K	A	W	Ñ	A	T	A	S	K
I	X	L	X	Ñ	W	Y	T	U	N	T	A
T	A	L	U	R	A	T	W	Y	A	Ñ	S
A	A	R	W	I	J	S	R	T	R	K	U
I	A	S	T	Y	U	I	W	Y	R	S	I
W	I	R	A	S	W	X	U	Ñ	X	U	Ñ



## 3. Arunaka thaqt'asisa jakisiyañäni wakisirimpi.

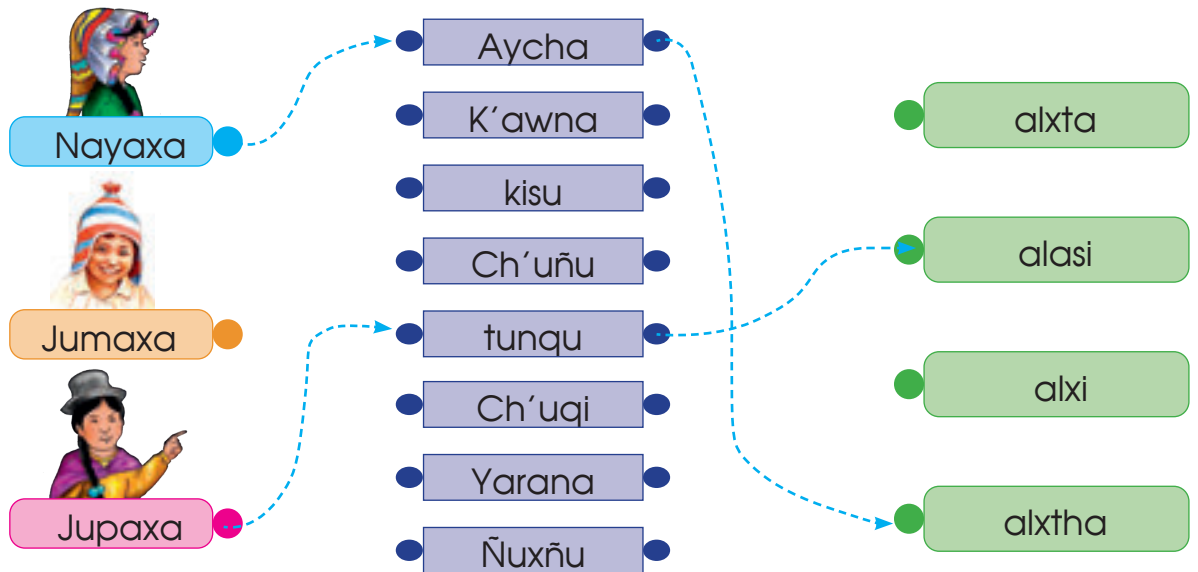

**Akiri arunaka thaqt'asa, akhama arunakampi arsuña yatiqapxañäni.**

**Alxta, alasi, alxi, alxtha.**

#### 4. Alxiri kullakanakampi aruskipapxañäni.

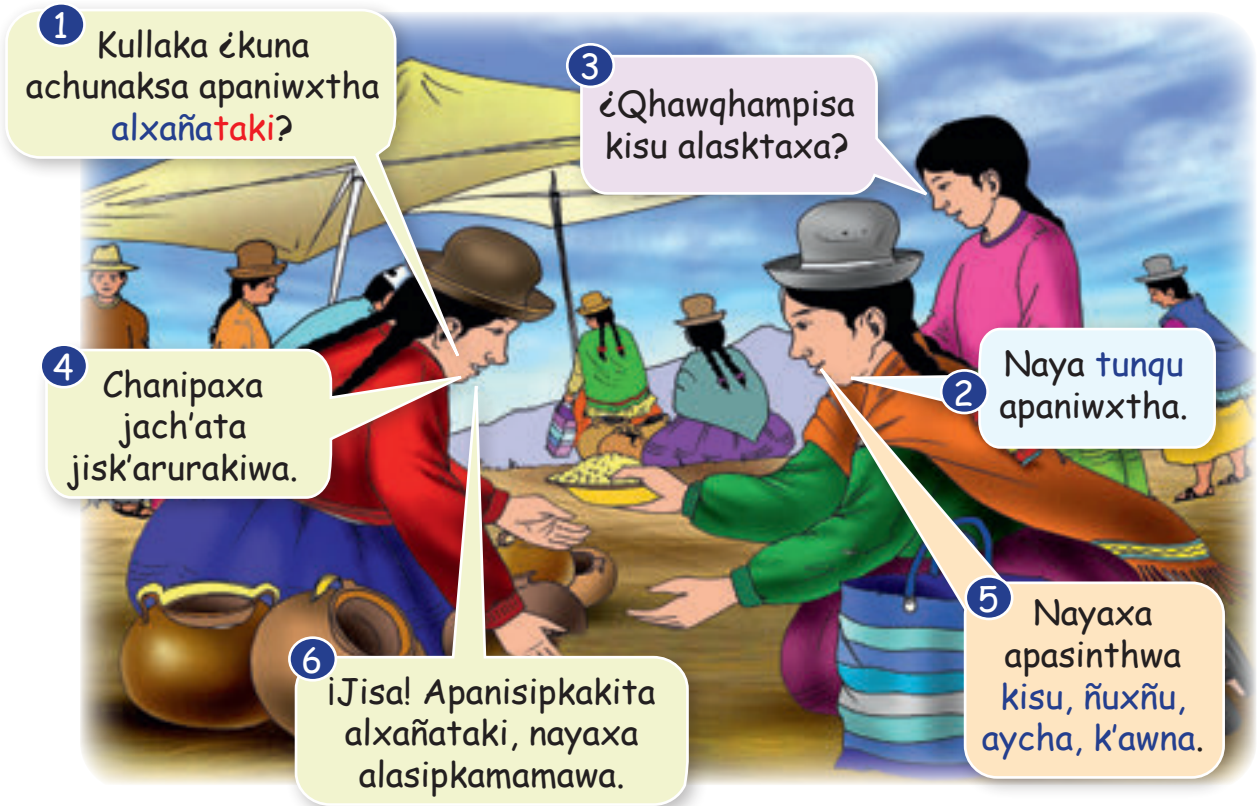

#### 5. Awkisampi, taykasampi utana alasiña, alxaña tuqita aruskipapxañäni.

¿Kuna manq'anaksa alataynaxa?

¿Kuna manq'anaksa apapxsnaxa alxañataki?



kisu

K'awna

Ch'uqi

Jawasa



**Akhama arunakampi arsuña yatigañäni.**  
Alxaña, alxañataki, alasiña, alasiñataki,...



¿Kunsa yatiqapxañanixa?

**Qhatuna isinaka alasiñatha aruskipapxañani.**

Isinaka alxaña tuqita uñt' apxañani



2 ¿Ukasti tunka phisqani sulisakiwa?

1 ¿Qhawqhasa uka isimaxa?

4 Iraqamamawa, apasmaya.

3 Jilarakisa, ¿janiti iraqitasma?



1. Maya warurt'a ist' apxañani, kikipa warust'añataki.



## Qhaturu sarapxañani

(turiru: wirsu)

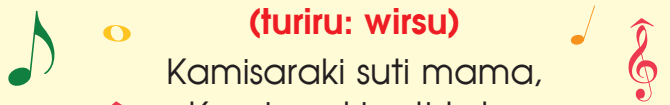
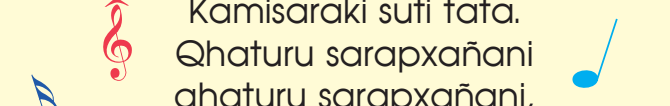
 Kamisarakí suti mama,  
 Kamisarakí suti tata.  

 Qhaturu sarapxañani  
 qhaturu sarapxañani,  
 kunaymana isinaka alasiniñataki  
 kunaymana isinaka alasiniñataki,  
 Alasiniñaniwa warmi isinaka,  
 Alasiniñaniwa chacha isinaka,  
 Alasiniñaniwa wawa isinaka  
 Saminakapawa k'achachapxchitani.



## 2. Qhatuna utjiri isinaka uñt'apxañäni.

1



2



3



4



5

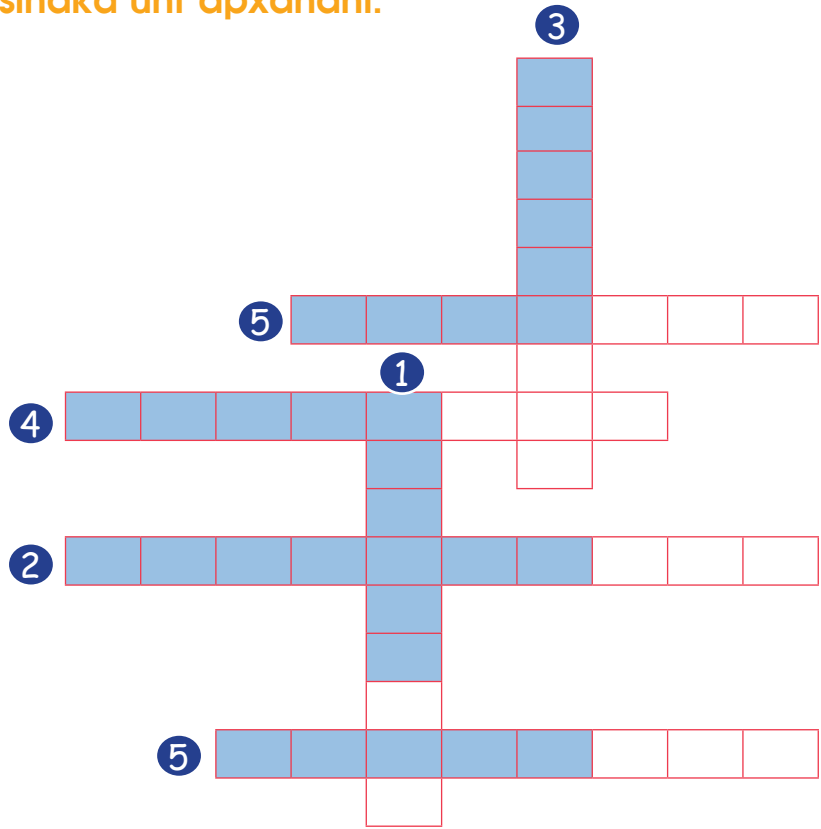

## 3. Jiwaspura aruskipañani, akiri chachaxa qhatutha akhama isinaka alasinitayna; jichhaxa samiparjama uñachayapxañäni.



Q'illu

Ch'umpi

Ch'iyara

Chupika

Larama

pantaluni

jiskhuni

sumiruni

Chumpani

Q'ipini



**Akhama arunakampi arsuña yatiqañäni.**  
Chacha isi, warmi isi, yuqalla isi, imilla isi, wawa isi.



#### 4. Ist'ata arunakampi jiwaspura arsupxañäni.

1 ¿Qhawqhampisa sumiruma alastha?

2 Sumiruja pä tunka sulisampiwa alastha.

4 Ch'ullujana chanipaxa tunka sulisawa.

3 ¿Qhawqhasa ch'ullumana chanipaxa?

5 ¿Qhawqhasa jumana awayumana chanipaxa?

6 Nayana awayujaxa pusi tunka sulisawa.



#### 5. Utana isina chaninakapa yatxatasa sich'intapxañäni.

S/. Pusi tunka sulisa



¿Kawkiri isina chanipasa ukjaspha?



Akhama arunakampi arsuña yatiqañäni.  
Isina saminakapa, isina chaninakapa.

# Manq'añanaka alasinipxañäni phayasiñataki



## ¿Kunsa yatiqapxañänixa?

Qhatuta rikarunaka alasinipxañäni phayasiñataki.

### Phayasiñataki rikarunaka uñt'apxañäni



### 1. Maya warurt'a ist'apxañäni, ukata kikipa warurt'apxañäni.



#### Alasiri sarañäni

Irpasitalla wayt'asitalla

Rikuwana uta tuqiru

Alxirinakasa suyasiniwa

Achunaka alxañataki.

Jina sarañäni jina sarañäni

Chuxña alinaka alasiri

Jina sarañäni jina sarañäni

Rikarunaka alasiri.



#### Akhama arunakampi arsuña yatiqañäni.

Rikarunaka, chuxña, achunaka, alxañataki, alasiri ...





## 2. Ch'uxña achunakana sutinakapa uñt'apxañäni.



pirijila



lichuja



ripullu



apiyu



siwulla



tumati



limuna



ajusa



kiyuna



## 3. Rikarunaka sutinakapa uñt'apxañäni.



arusa



phiriyusa



asiti



asukara



jak'u



jayu



**Akhama arunakampi arsuña yatiqañäni.**

Ch'uxña achunakana sutinakapa,  
rikarunakana sutinakapa.



#### 4. ¿Kuna rikarunaksa qhatuta alaniwapxtaxa?

1 Tata ¿kuna rikarunaksa alaniwapxtaxa?

2 Chuxña achunaka, rikarunaka, phayasiñataki alaniwapxtha.

3 ¿Arusampixa kunanaksa phayasipxsnaxa?

4 Aarusa kaltu, arusa k'aja phayasipxsnaxa.

5 ¿Ch'uxña achunakatxa kunsaxa lurapsnaxa?

6 Sarsanaka, manq'anaka sasunañatakiwa.



#### Utana manq'anaka phayasiñxata aruskipapxañäni ukata phuqachapxañäni.

tumatimpi      asitimpi

siwullampi      Arusampi

Sarsanaka, manq'anaka phayasiñataki

\_\_\_\_\_

\_\_\_\_\_

\_\_\_\_\_

\_\_\_\_\_

kaltu      k'aja      thaxtiña      sarsa



## ¿Kunsa yatiqapxañänixa?

Manq'a phayatanaka uñt'apxañäni yatiqañataki.

## Kunaymana manq'anaka uñt'apxañäni



2 Chawlla wallaqi, chawlla thaxti, juchha, p'isqi, uxu, juchhacha, warxata, t'imphu, ispi thixi, pijiriya thixi, khuchi chicharuna.

1 Kullaka ¿Kuna manq'anaksa phayt'aniwtaxa?

3 Jumaxa, ¿kunsa manq't'asita?

4 Wali sumawa yapt'amamawa.

5 Nayaxa chicharuna manq't'asija.



## 1. Maya warurt'a ist'apxañäni, kikipa warurt'añataki.



### Phayt'asiri kullaka

#### Balserito - Wirsu

Phayt'asiñani kullaka  
Phayt'asiñani jilata. ( kuti )

Jiwasanakana muxsa achunakasa  
Jiwasanakana ch'ullqinchiri  
achunakasa. ( kuti )

Chawlla thaxthi, khuchi kanka, warxata,  
juchhacha

manq'asipxañani suma q'uma  
jakasiñataki ( kuti ).



**Akhama arunakampi arsuña yatiqañäni.**

Phayasiñanaka, manq'asipxañäni.



2. Tataxa kuna manq'anaksa manq'i ukanaka arsupxañäni.

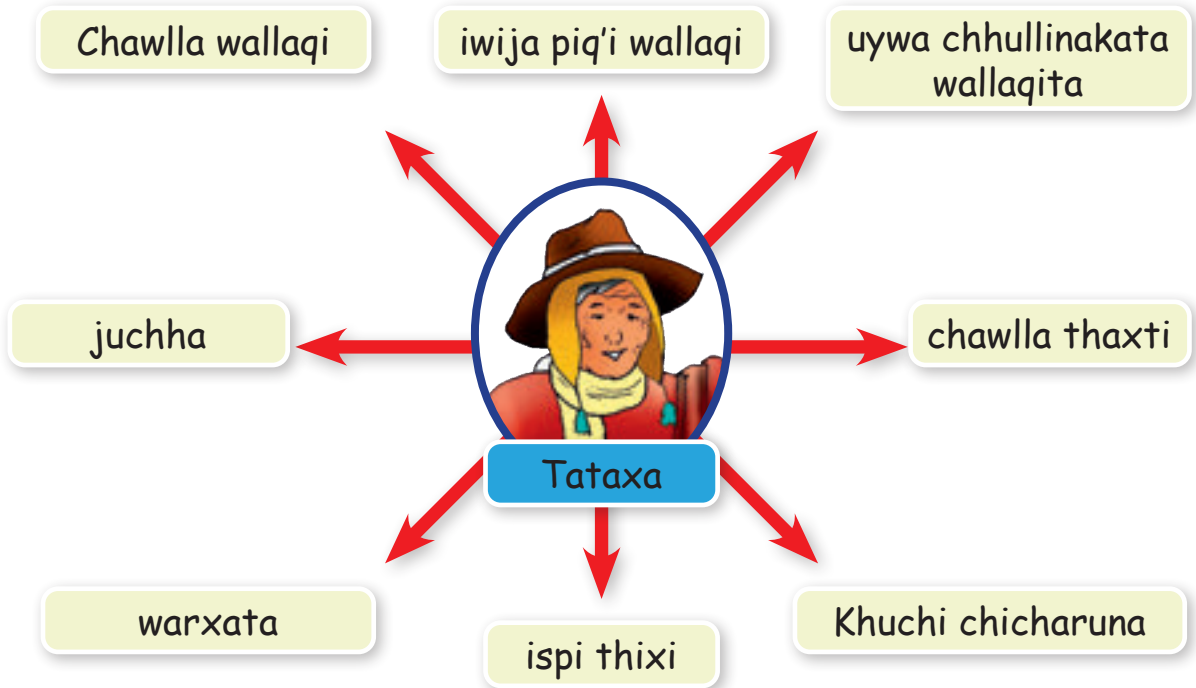

3. Amuyt'äsina jakisiyapxañäni arunaka anatayäsina ¿kuna manq'sa tataxa manq'i, alasi, phayasi uka arunakampi?

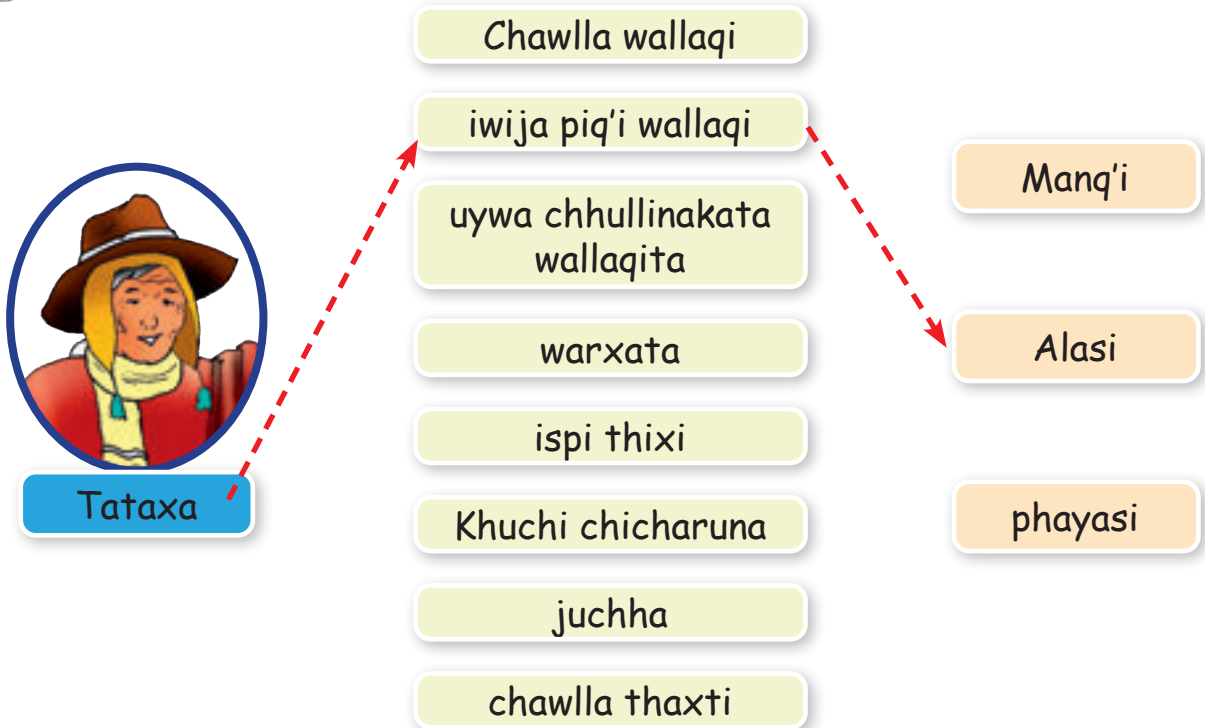

**Akhama arunakampi arsuña yatigañäni.**  
Manq'anakana sutipa, manq'i, alasi, phayasi.



4. Qutuchas'inxaxa, yatiqiri masinakasampi kuna manq'anaksa manq'apxi ukata aruskipapxañani.

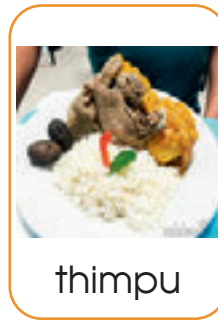
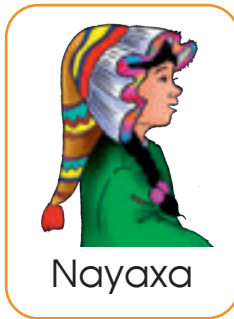

5. Arunaka suma amuyumpi jakisiyapxañani, utana awky taykaru jiskt'äsina kawkiñi manq'sa alasi, manq'i ukanaka.

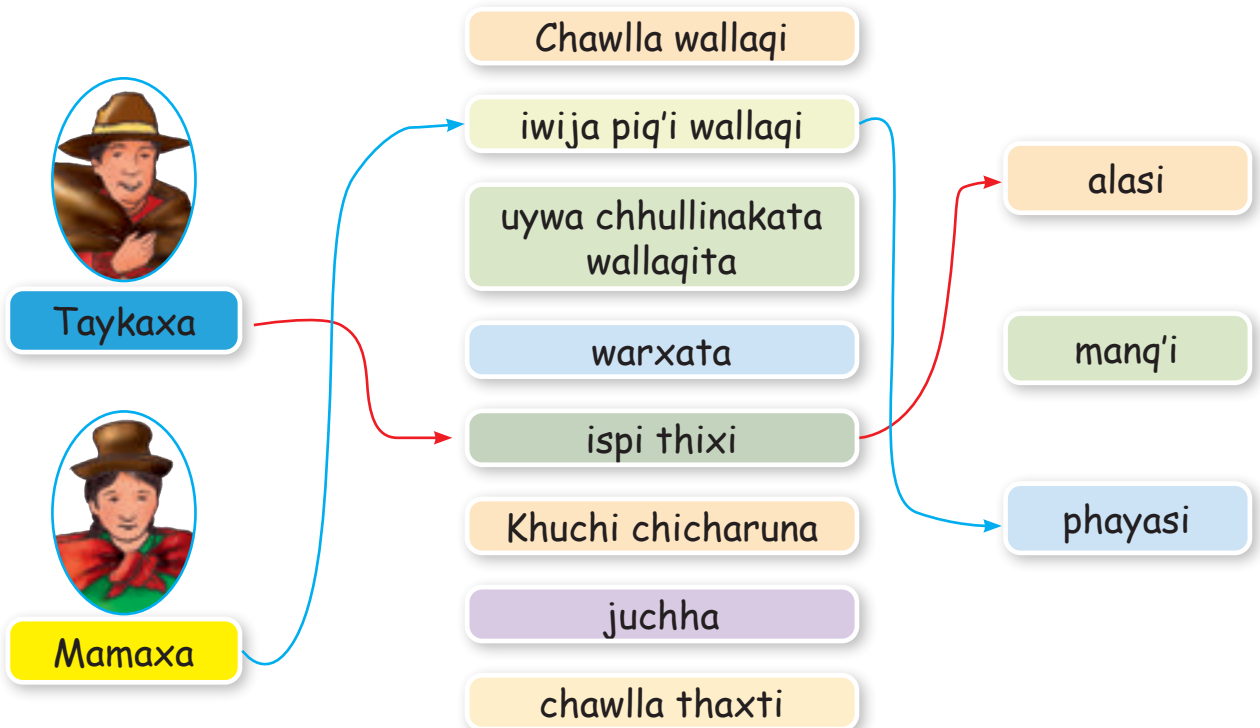

**Akhama arunakampi arsuña yatichsituwa.**  
Alasi, manq'i, phayasi.

# Qhatuna masinakampi jakisipxañäni



## ¿Kunsa yatiqapxañänixa?

Qhatuna masinakasampi jakisiwasina aruskipapxañäni.

### Alasipxañani rikarunaka phayasiñataki



### 1. Maya warurt'a ist'apxañäni, kikipa warurt'añataki.



#### Kawkitsha purinta

##### Achuqalla - wirsu

Tatanaka mamanaka kawkitsha purinta  
Tatanaka mamanaka kawkitsha purinta  
kuna alxañsa apantha, kuna alxirisa jutä  
kuna alxañsa apantha, kuna alxirisa jutä.

Aychanaka alxiriti,  
Kisunaka alxiricha,  
Muxsa puqutanaka alasiwayatha  
Janiwa armasiwätati.



**Akhama arunakampi arsuña yatiqañäni.**  
Masinakampi jakisiña, kawkitsha purinta, jakisiña.



## 2. Jichhaxa yatiqiri masinakampi aruskipapxañäni askipacha ist'apxañäni alaña alxaña tuqita.



## 3. Manq'anakana sutinakapa alxata, alanita thaqhapxañäni.

1. Kisu
2. Ñuxñu
3. Aycha
4. Chuq'i
5. Tunta
6. Jawasa
7. Latanusa
8. Larankha
9. Uwasa
10. Arusa
11. Asiti
12. Jayu
13. Jak'u
14. T'ant'a

T'	A	W	R	K	I	S	U	Y	K'	I	S
X	A	I	T'	R	Y	M	W	N	K	Y	J
J	Y	J	A	Y	U	R	A	P'	Q'	I	A
T	H	A	N	T	H	A	S	I	S	I	W
N	Y	K	A	M	X	S	A	Y	C	U	A
U	T	A	S	U	R	A	Y	C	H	A	S
X	T'	A	I	W	N	Y	M	T	U	U	A
Ñ	Y	Y	T	U	K'	A	J	R	Q'	I	S
U	W	J	I	X	R	A	R	T	I	R	U
K	K'	A	W	R	S	U	T'	A	N	T'	A
T	Y	U	A	S	U	N	A	T	A	L	W
X	H	J	K	L	L	Ñ	Ñ	U	X	J	I
R	Y	U	S	T	U	N	T	A	A	H	K



**Akhama arunakampi arsuña yatiqañäni.**  
Manq'anakana sutipa, alxata, alanita achunaka.



#### 4. Khitimpisa markana tataxa jakisini uka katjañani.



Tataxa



qhatuna



Mariya  
kullakampi



yatichirimpi



jakisiwa



Tataxa ékhitimpisa jakisi?



imillampi



yuqallampi



Mariya kullakampi



#### 5. Tataru utana jiskht'apxañani khitinakampisa qhatuna jakisitayna uka phuqachapxañani.

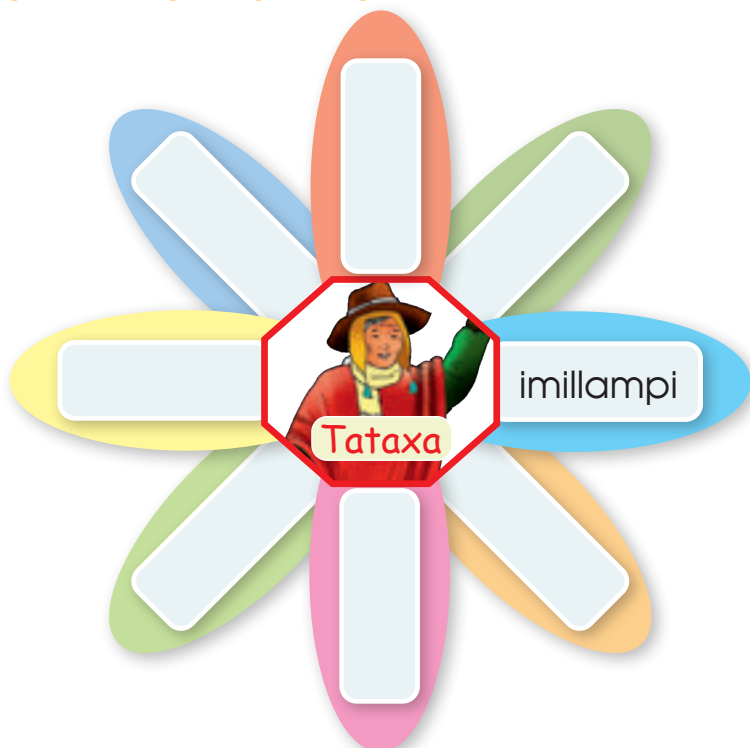



# Jayatha jutiri jaqinaka qullanaka alxiri



## ¿Kunsa yatiqapxañäni?

Qullanaka alxiri jaqinakampi qullasiñata aruskipapxañäni.



1 Tatanaka, mamanaka, waynanaka, tawaqunaka, jisk'a wawanaka jak'achasinipxma kunayma usunakatakiwa qullanaka apaniwxta.

2 ¿Kuna usunakatakisa qullanaka apantasti?

3 COVID usutaki, ch'aka usutaki, jikhani usutaki, jurma usutaki, junt'u usutaki, thaya usutaki apaniwxta.



## 1. Maya warurt'a is'apxañäni, kikipa warurt'añataki.



### Qura qullanaka Awki awki - wirsu

Qura qullanakawa wali qullaxa  
Qura qullanakawa wali qullaxa  
Junt'u qullanaka, thaya qullanaka wallaqiyapxañäni.  
Junt'u qullanaka, thaya qullanaka wallaqiyapxañäni.

Qullasipxaraksnawa k'aja usunaka  
Qullasipxaraksnawa ch'aka usunaka  
K'umaraki jakasipxañäni,  
Taqi jiwasanakaxa.



**Akhama arunakampi arsuña yatiqañäni.**  
Qura qullanaka, junt'u, thaya qullanaka



## 2. Jichhaxa qulliri jaya jaqimpi aruskipapxañani.



1 Tata, ¿kuna usu qullañatakisa apantaxa?

3 ¿Ch'aka usutaki kunasa walixa?

2 Naya akiri usunakatakiwa qullanaka apantxa: COVID usutaki, ch'aka usutaki, jikhani usutaki, jurma usutaki, junt'u usutaki, thaya usutaki.

4 Jawisiñataki, qura qullanaka apantxa.



## 3. Yaqha jaqina qullanakapa apanitapa chimptapipxañani.



Ch'aka usutaki

Isinaka isisiñataki

Chua'i phayasiñataki

anatañanaka anatañataki.

Jikhani usutaki

Jurma usutaki

Jun't'u usutaki.

Awayunaka awayusiñataki.

Uta utachasiñataki.

Qura qullanaka

Thaya usutaki

Uywanaka uywañataki.

COVID usutaki.



**Akhama arunakampi arsuña yatiquañani.**  
**Mirayachiri arunaka naka.**



#### 4. Awicharu jiskht'apxañäni jiwasana qullanakasatha.

2 Wawanaka jiwasana qura qullanakawa utji.

4 Utjiwa: yukalitu, wirawira, muña, chachakuma, yarita.

6 Uka qullanaka yaqha markanakatha apanipxixa.

7 Jiwasaxa qura qullanakampi qullasiñatanwa.

1 Awicha ékuna qullanakasa jiwasana utji?

3 éKunanakasa uka qura qullanakaxa?

5 éPastillanaka kikipati, jani ukhaxa yaqhacha?

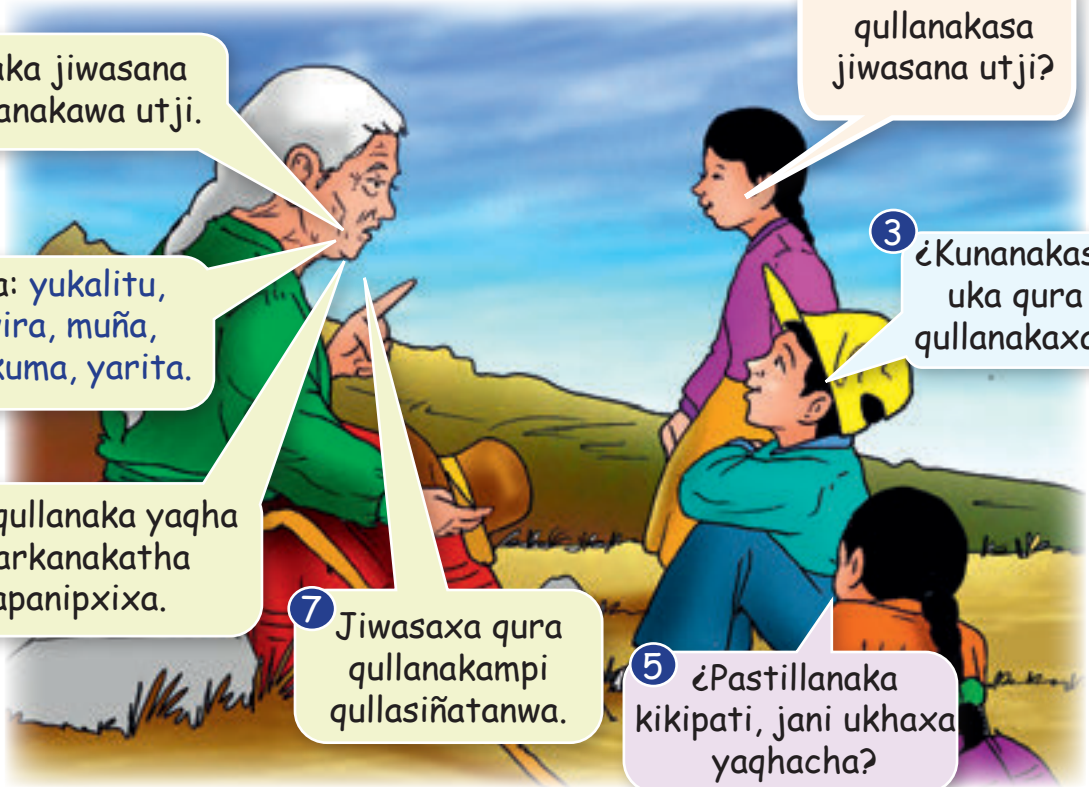

#### 5. Utana wilamasinakasampi aruskipasa k'atampi jaya jaqinakata yatxatapxañäni.



Qullanaka alakipirinaka, Markata markaru sarapxi jaqinakaru qullasiña yatichapxi.

éKunanaksa uka jaya jaqinakaxa lurapxpachä?



Tataxa



Masijaxa



Kullakajaxa

Siwa jaya jaqinakaxa

Qullanaka alxakipiri.

Markata markaru sarapxi.

Jaqinakaru yatichapxi.

# Yatiqatasanaka uñacht' ayapxañäni



## ¿Kunjamsa yatiqatasa uñacht' ayapxañäni xa?

Yatiqatasa sapa mayni amtapxañäni, ukata akhama  sich'impi sich'intapxañäni.

Kunanaksa yatiqatatxa uka uñakipaja	Janirawa yatiqkti	Yatiqawtha
1. Qhatuna achunaka alxaña alasiñataki yatiqañapxañäni.		
2. Qhatuna isinaka alasiñata aruskipapxañäni.		
3. Qhatuta rikarunaka alasinipxañäni phayasiñataki.		
4. Manq'a phayatanaka uñt' apxañäni yatiqañataki.		
5. Qhatuna masinakasampi jakisiwasina aruskipapxañäni.		
6. Qullanaka alxiri jaqinakampi qullasiñata aruskipapxañäni.		

## ¿Kunsa lurapxañänixa? Kisu atiña yatiqapxañäni qhaturu apañataki.



### Kisu Atiña

#### 1. ¿Kuna yänakasa wakisi kisu atiñataki?



ñuxñu



kuwaju



Jayu



Istira wak'a



## 2. Yatxatapxañäni ¿kunjamasa kisu luraña uka tuqita?

1



Wakata ñuxñu ch'awaqaña.

2



Ñuxñu tantachiriru apayaña.

3



Ñuxñu mä phukuru junt'uchasa  
kuwajumpi **warantaña**.

4



Niya kuwajumpi tikantipana  
**jirtaña**.

5



Jayumpi warantaña ukhama  
**atsuña**.

6

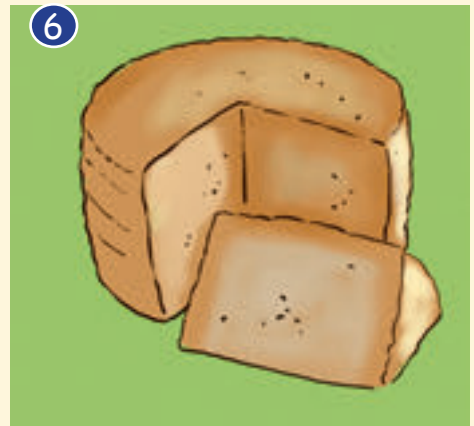

Istiraru, wak'aru atsuña ukata  
**ch'uarayaña**.



### 3. ¿Kunjamsa uka luratasa uñacht' ayañanixa?

1. Nayraqataxa kisu luririnakjamawa amuyapxañäni.



Taqiniwa maynita maynikama luratasa arsupxañäni.



2. Panini paniniwa luratasatha aruskipapxañäni.

1

Nayraqata wakata ñuxñu ch'awaqaña.



3

Ñuxñu mä phukuru junt'uchasa kuwajumpi warantaña.



2

Ukatxa ñuxñu apthapiruru apayaña.

4

Niya kuwajumpi tikantipana jirtaña.



5

Jayumpi warantaña ukhama atsuña.



6

Istiraru, wak'aru atsuña ukata ch'umarayaña.



6

T'AQA

# Kunaymana uywanaka uñt'apxañäni

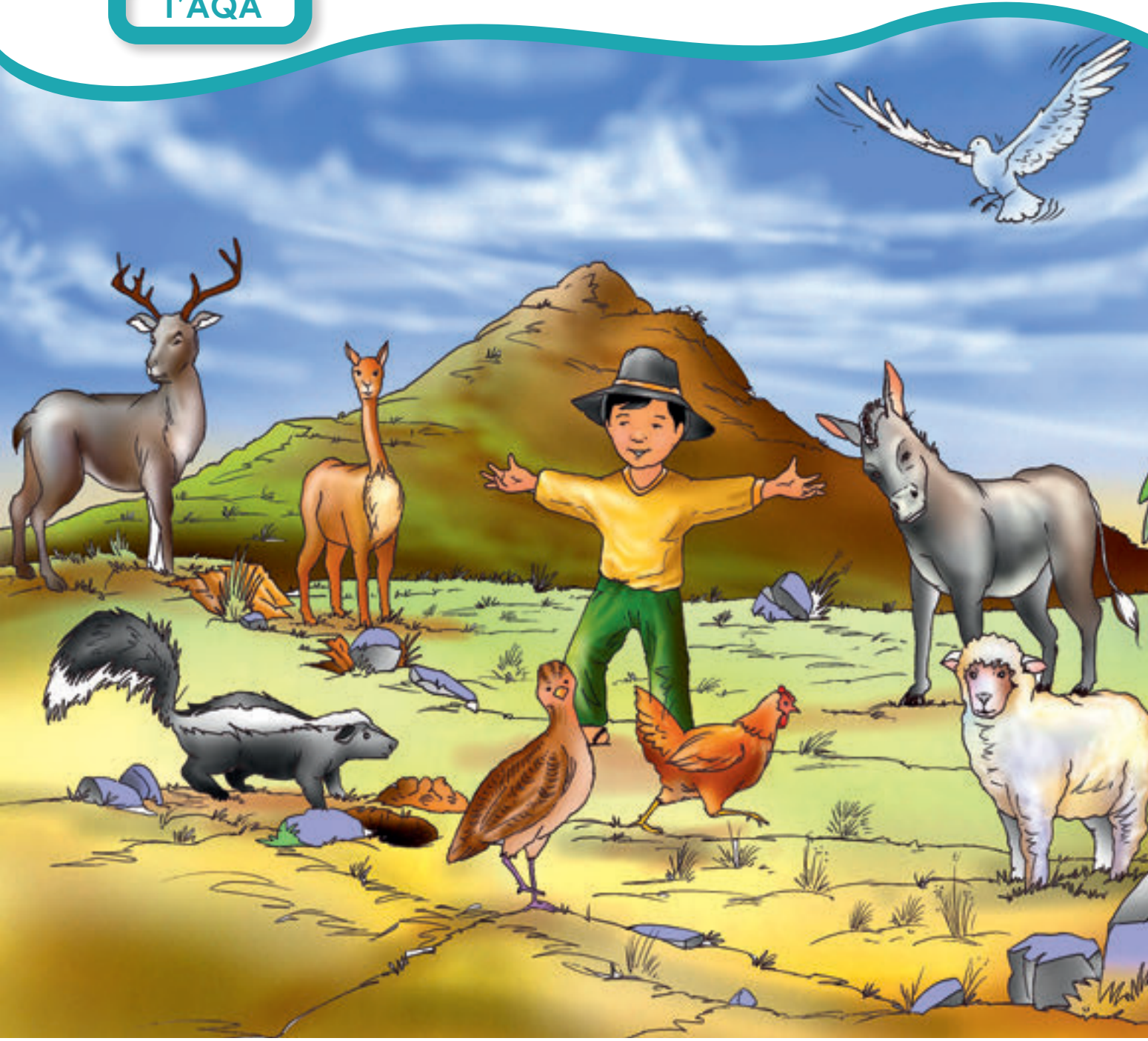

¿Kunsa uywanakatha yatisipkthanxa?  
¿kunanakasa uywanakatha yatxathañaspaxa?



# Uta uywanaka uñt'apxañani



¿Kunsa yatiqapxañanixa?

Utana utjiri uñt'ata uywanakata aruskipañani.

1 Jumaxa ékuna uywanaksa uywachastasti?

4 Nayaxa uywastwa allpachu, qhawra, kawallu, asnu, anu

2 Jilata, wakajaxa janiwa alxañakiti.

3 ¿Jumasti kunsa uywta?

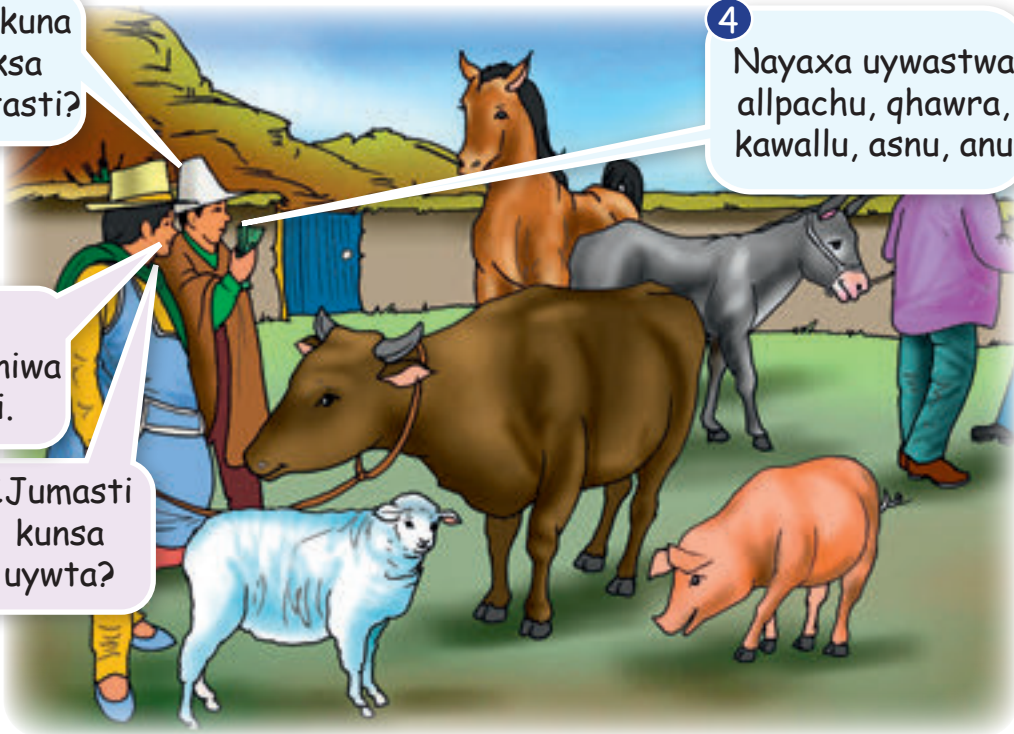

1. Maya warurt'a ist'apxañani, kikipa warurt'añataki.



**Uywanakasa Warurt'apa**

Sale el sol - Wirsu (Huayño)

Nayana janq'u uwijawa  
Jumana ch'umpi allphachuma  
Jupana jach'a wakapa  
Taqinanakana uywanakapa. (kuti)



**Akhama arunakampi arsuña yatiqañani.**

Mirayachiri arunaka **naka**





## 2. Kuna uywanaksa uywasipxtana uka uñ'apxañani.

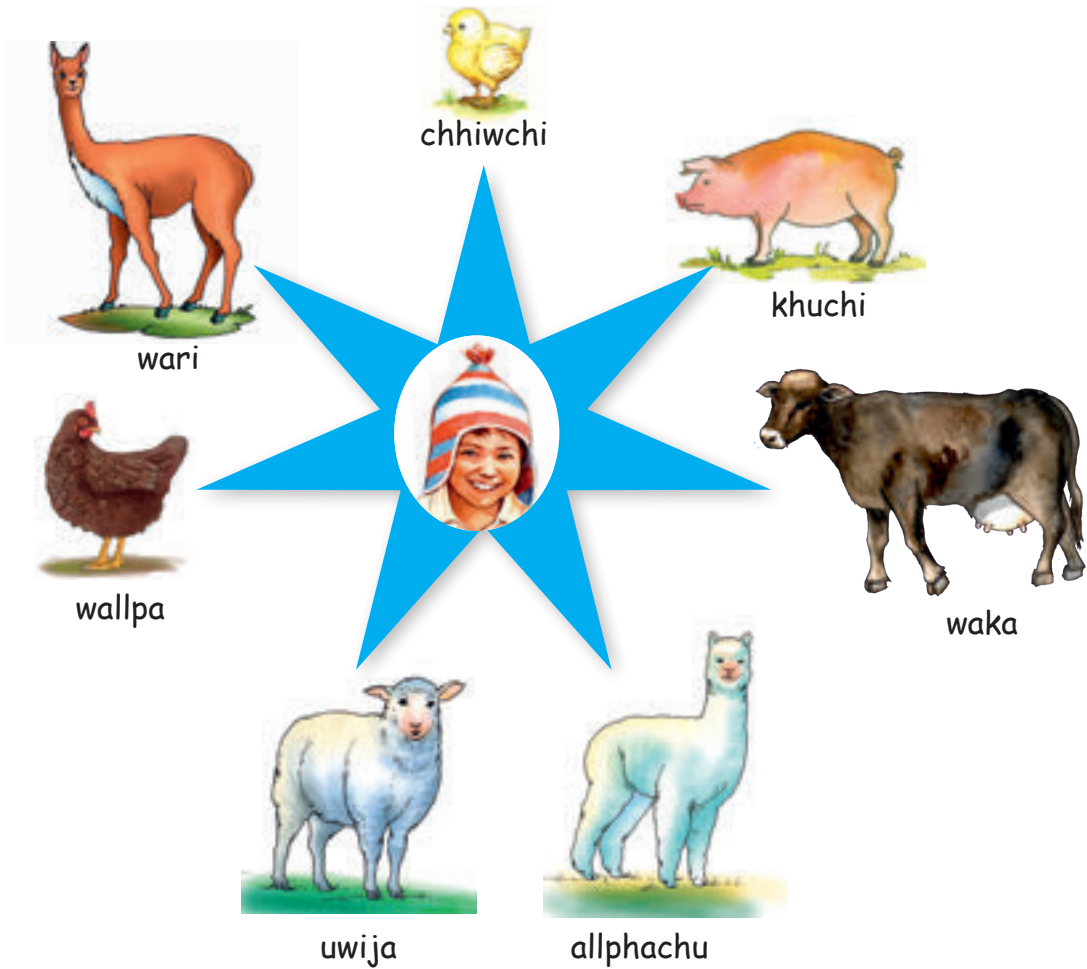

## 3. Yatiqiri masinakasampi uywanaka tuqita aruskipapxañani.

1 ¿Kuna uywanaksa uywachastasti?

4 Nayaxa uywachasthwa: waka, allpachu, qawra, phisi ukakiwa utjitu.



2 Nayaxa uywachasthwa waka, iwija, wallpa, wank'u, phisi ukanakwa.

3 Jumaxa ¿kuna uywanaksa uywachastha?



Akhama arunakampi arsuña yatiqañani.  
Uywanaksa, uywachastasti, uywachasthwa.



4. Akiri uywanakata ¿kawkirinakasa jiwasa tuqina utjixa?  
Ukanaka muyuntayma.



5. Mariyampi Julikumpixa utanakapana kawkiri uywanaksa  
uywasipxi uka jamuqäsina phuqachapxañäni.



				
Waka				



				
chhiwchhi				



Akhama arunakampi arsuña yatijañäni.  
Utana uywasiptana, uka uywana uñ'apxañäni, ...

# Wilmaxa utapankiri uywanaka sumachi



¿Kunsa yatiqapxañänixa?

Utana uywanaka uywachaña yatiqapxañäni.

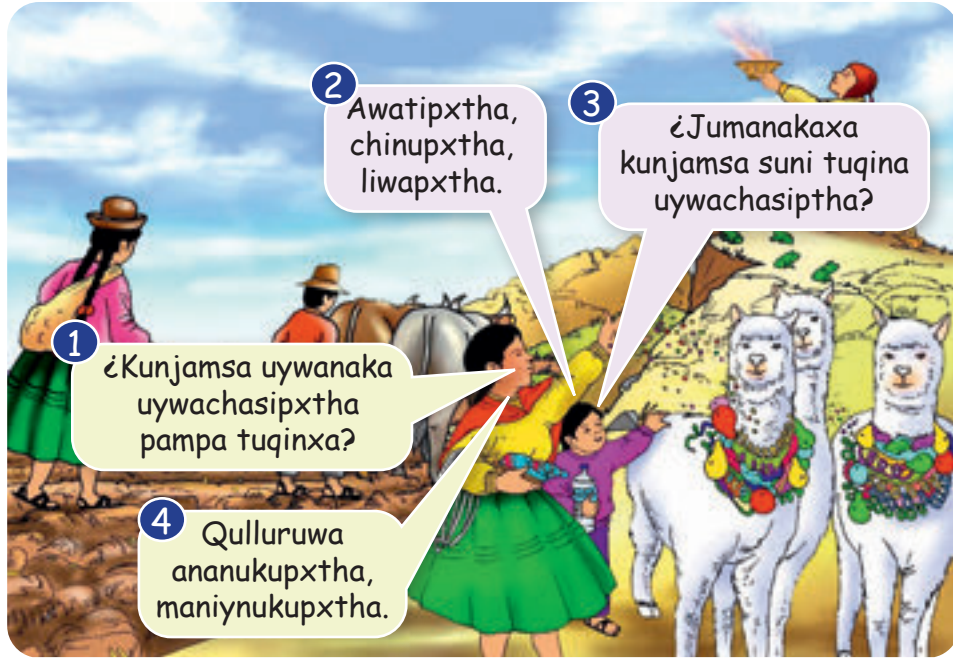

1. Maya jarawi ist'apxañäni, kikipa jawar'tañataki.



## Suma Allphachu (Jarawi)

Suma allpachutawa,  
Suni taypina jakasiri;  
jaqinakana wali munata, ukatwa nayaxa  
jumaru uywasma; qulluna, pampana  
jakasiri.

T'awramasa suma quñaki, wali suma  
munatatawa; jaqinakana, ukatwa  
uywasipxtama qulluna, pampana jakasiri.



Akhama arunakampi arsuña yatiqañäni.  
Uywanaka uywasiñani, uywasipxtanwa, ...



## 2. Wilmana uywanakapa uywatapa uñt' añataki ukana sutinakapa katjapxañäni.



1. Waka
2. Iwija
3. Allpachu
4. Qawra
5. Asnu
6. Wallpa
7. Phisi
8. Anu
9. Kawallu
10. Wank'u
11. Chhiwchhi
12. Chhanka

A	N	U	T'	U	R	S	U	K'	N	A	W	W
P	C	H	H	A	N	K	A	K	A	S	I	T
H	T	R	K'	U	I	W	A	K	A	W	W	Y
S	U	T	S	R	T	Y	K	Ñ	S	A	I	A
U	H	C	A	P	L	L	A	W	R	Y	J	Q
R	S	Y	R	Q	Q	C	H	H	Y	W	A	Q'
Q	Q	A	W	R	A	Q	W	A	R	A	Y	R
Y	R	P	C	H	H	I	W	C	H	H	I	Y
C	H	H	I	W	C	W	A	L	L	P	A	T
I	Y	I	K	M	A	S	Y	W	I	S	T	U
P	H	S	L	R	T	Y	I	P	Q	Y	U	W
Ñ	L	I	Ñ	W	U	U	N	S	A	R	W	X
K	A	W	A	L	L	U	K	W	A	L	L	I



## 3. Akiri arunakampi qillqasa phuqachapxañäni.



Wilmaxa

waka

iwija

allpachu

qawra

asnu

phisi

wallpa

awati

uywasi

chinu

alisnuku

maniynuku

liwasi

waxtasi



**Akhama arunakampi arsuña yatiquañäni.**  
Awatiña, uywasiña, chinuña, alisnukuña,  
maniynukuña.



4. ¿Kuna uywanakasa Wilma kullakana utjixa? jachata arsupxañani.

wallpa

Wilma kullakanxa walja uywanakawa utji.

qawra

allphachu

phisi

waka

asnu

iwija



5. Aka uywanakana utana jakthapipxañani.



Kimsa iwija



Akhama

jakthaptha



Akhama arunakampi arsuña yatiqañani.  
Jakhuña, jakthapiña, jakthapisa, ...

# Uywanaka miriri uñjapxañäni



¿Kunsa yatiqapxañänixa?

Uywanaka uñt'apxañäni qhawqha phaxsitsa mirixa.

Uta uywanakana mirawipa.

3 ¿Uwijaxa qhawqha phaxsitsa wawachi?

2 Wakaxa llatunka phaxsita, tunka phisqhani uru saraqatatwa wawachixa.

1 Awicha éwakaxa qhawqha phaxsitsa wawachi?

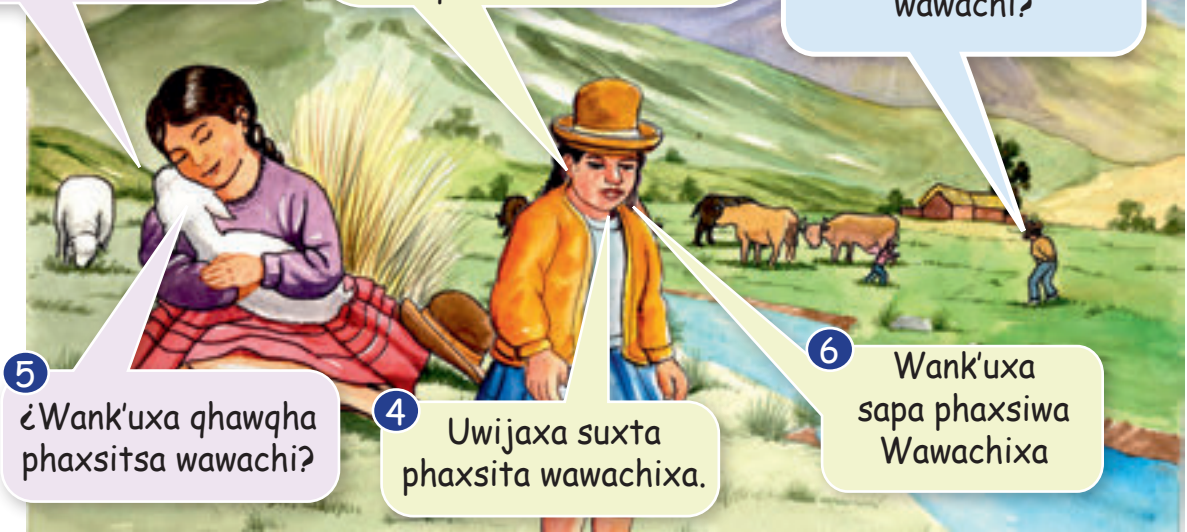

5 ¿Wank'uxa qhawqha phaxsitsa wawachi?

4 Uwijaxa suxta phaxsita wawachixa.

6 Wank'uxa sapa phaxsiwa Wawachixa



1. Maya Jawari ist'apxañäni.



Suma uywanaka

Suni tuqinwa utjastha  
Uywanakajampi chikawa utjastha  
Juyphimpi, jallumpi chika sarnaqasirithwa.

Uwija qallunaka Allpachu qallunaka  
Suma mirayasiritwa Suma utjasiñataki  
Uywanaka suma uywasipxañäni.



Aymarata jarawt'asa, akhama arunakampi arsuña yatiqañäni.

Uywanaka witiyasiri, utjasiri, yäqasiri.



## 2. Kunjamsa uywaxa mirixa uka yatxatapxañani.

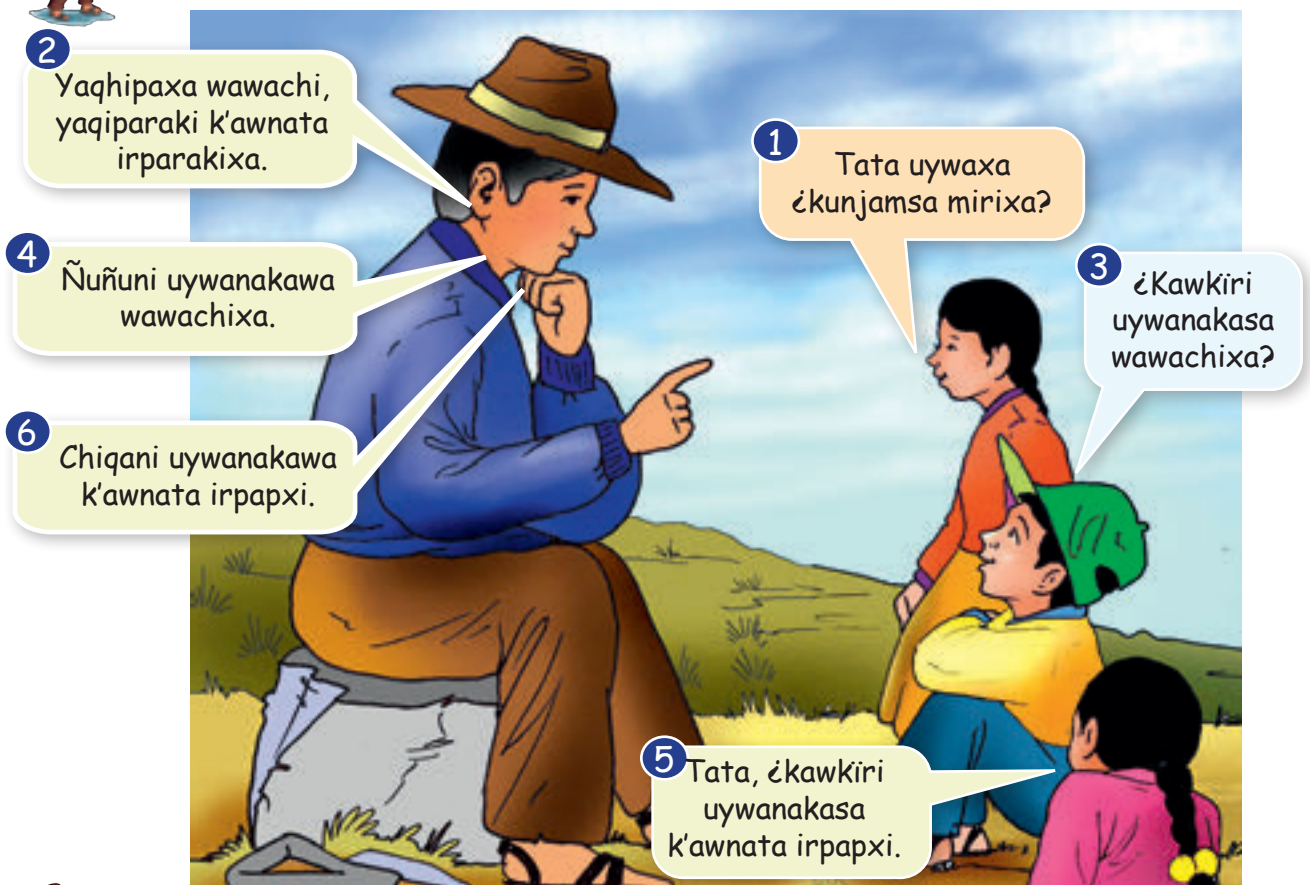

## 3. ¿Kujamsa mirapxi uka jakisiyañani?

Wakaxa ●

wallpaxa ●

allpachuxa ●

iwijaxa ●

pawuxa ●

qawraxa ●

patuxa ●

asnuxa ●

● Wawachi

● K'awnata irpsu



Akhama arunakampi arsuña yatiqañani.  
Wawachi, k'awnata irpsu.



#### 4. Aruskipapxañani ¿Qhawqha phaxsitsa uywa mirixa?

1 Tata, ¿qhawqha phaxsitsa wakaxa wawachi?

2 Wakaxa llatunka phaxsita tunka phisqhani uru saraqatatwa wawachi.

3 Wallpasti ¿qhawqha urutsa chhiwchhi irpsu?

4 Wallpaxa pätunka mayani urutwa irpsuxa.

5 Iwijasti ¿qhawqha phaxsitaraksa wawachi?

6 Iwijaxa suxta phaxsitwa wawachixa.



#### 5. Utana yatqatapxañäni awkinakaru jiskht'asa uywanakaxa ¿Qhawqha phaxsitsa mirixa?

Wakaxa <input type="radio"/>	<input type="radio"/> Llatunka phaxsita wawachi
wallpaxa <input type="radio"/>	<input type="radio"/>
allphachuxa <input type="radio"/>	<input type="radio"/>
iwijaxa <input type="radio"/>	<input type="radio"/>
patuxa <input type="radio"/>	<input type="radio"/>
qawraxa <input type="radio"/>	<input type="radio"/>
pawuxa <input type="radio"/>	<input type="radio"/>
asnuxa <input type="radio"/>	<input type="radio"/>



# Uywa qhatu sarapxañäni



¿Kunsa yatiqapxañänixa?

Uywanaka alxaña, alasiña yatipxañäni.

Uñt'apxañäni kuna uywanakasa alasiña wakisixa



1. Maya warurt'a ist'apxañäni, kikipa warurt'añataki.



## Uywa alxaña

**Wirsu- jumapuniwa kutiyanista**

Axura qhatu saraskipansa,  
Jumapuniwa kutiyanista. (kuti)

Yunta turu alxaskipansa,  
Jumapuniwa kutiyanista. (kuti)

Chhita uwijaxa alxaskipansa,  
Jumapuniwa kutiyanista. (kuti)



**Akhama arunakampi arsuña yatiqañäni.**

Uywanaka uywasinani, uywasipxtanwa, ...



## 2. Tataru jiskht' apxañäni ¿kunjamaskisa uywanakana alakipapaxa?

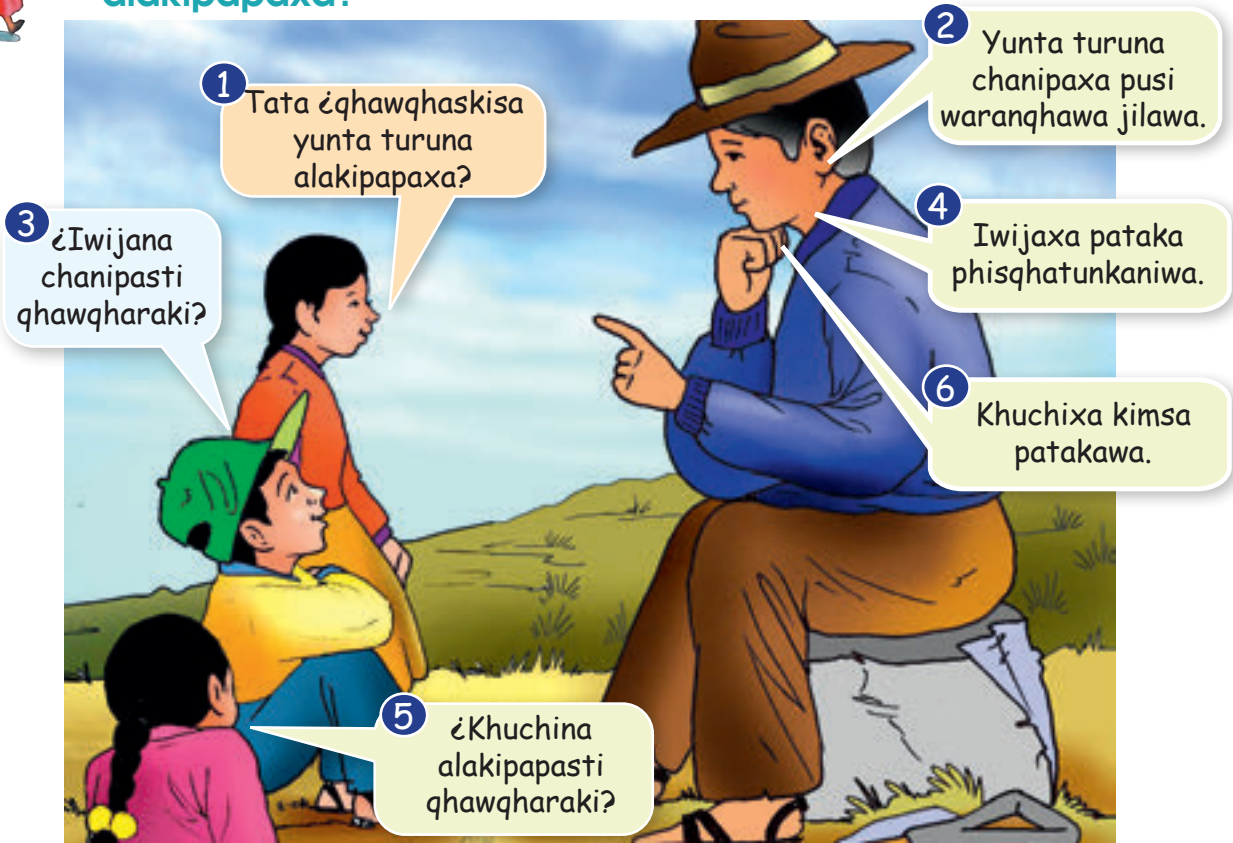





## 3. Axura qhatuna uñt' apxañani ¿kuna uywanakasa alxasi?



Akhama arunakampi arsuña yatiqañäni.  
Chanipa, alakipapa, **naka**.



4. Qutuchasisinxá, yatiqiri masinakasampi yatxatapxañäni, uywanaka chanipa sich'intapxañäni.

				
Pataka phistunkani	Kimsa pataka	Paya waranqa	Pusi pataka	Suxta pataka







¿Kawkipiri uywana chanipasa ukjaxa?

		
allphachuna	wakana	qawrana



5. Jamuqanaka uñxatäsina, utana uñt'apxañäni sapanaka ukhamaraki waljachirinaka sich'intapxañäni.

Jamuqanaka	Sapanaka	Waljachirinaka
	waka <input type="radio"/>	wakanaka <input type="radio"/> <input type="radio"/>
	alpachu <input type="radio"/>	allpachunaka <input type="radio"/> <input type="radio"/>
	iwija <input type="radio"/>	iwijanaka <input type="radio"/> <input type="radio"/>
	qawra <input type="radio"/>	qawranaka <input type="radio"/> <input type="radio"/>



Akhama arunakampi arsuña yatichsituxa. Sapanaka, waljachirinaka.

# Kunaynama kasta kasta uywanaka



¿Kunsa yatiqapxañanixa?

Uywanaka kasta kasta lakiña yatiqapxañani.

**Uñt'apxañani kuna uywanaksa awatisipxtana**

1 ¿Kawkiri uywnakasa t'awranixa?

2 Uwija, allphachu, qawra, anu, phisi, ...

3 ¿Kawkiri uywanakasa phuyunixa?

4 Wallpa, chhankha, un kaylla.



**1. Maya katjawi ist'apxañani.**



**Katjawi**

Kunasa, kunasa  
Maya uywatwa  
Utana jakasiri  
Jaqinakaru sartayiri  
Warminaka suma uywasiri  
Jani qiwssasisa.  
¿Kuna pachasa?



**Akhama arunakampi arsuña yatiqañani.**  
Uywanaka laqiña, phuyuni, lip'ichini, t'awrani, ...



## 2. Jichhaxa yatiqiri masinakampi aruskipapxañäni ¿kunjamsa uywanaka laqinuqaxsnasti?

Tata ¿kunjamsa uywanaka jalanuqaxsnasti



- waka
  - iwija
  - allpachu
  - phisi
  - anu
  - qawra
  - wallpa
  - chhankha
  - unkaylla
- Lip'ichininaka
- phuyuninaka

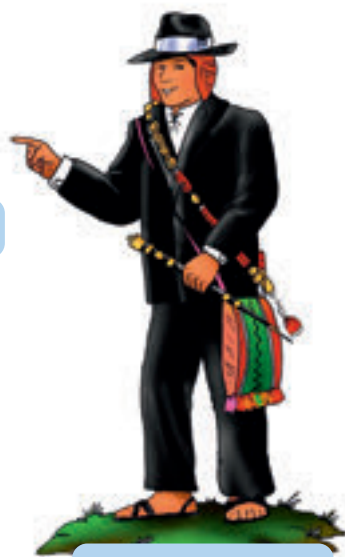

laqinuqsnawa



## 3. Lip'ichini, phuyuni uywanaka k'atampi uñt'askakiñäni.

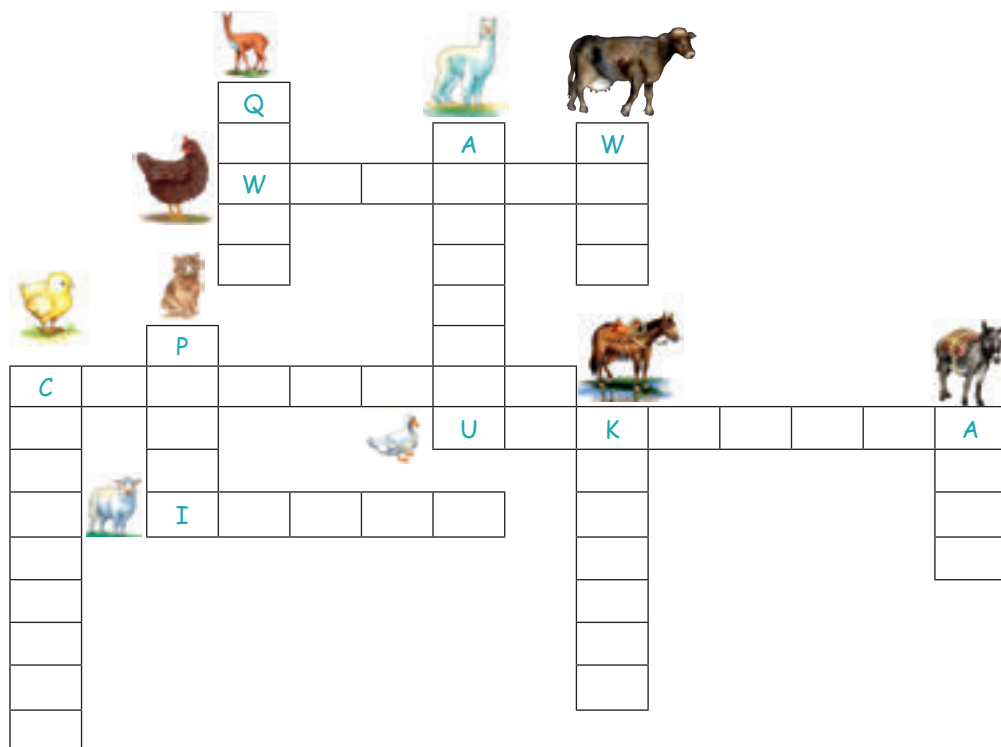

Akhama arunakampi arsuña yatiqañäni.  
Lip'ichini, phuyuni, uywanaka ...



4. Yatichirisampi aruskipapxañäni kunjamsa yatichirisampi uywanaka lakinuqsna uka tuqita.



1 ¿Kunajamsa uywanaka lakirapxsna?

6 Lakirapxsnawa: t'awrani, lip'ichini, phuyuni.

2 Kasta kasta iwijkama, allphachkama..., lakirapsnaxa.



3 Qachunaka, urqunaka ukhamsa yaqharu, yaqharusa lakiraksnawa.

4 Lakirapxsnawa jisk'a qallunaka, urwayanaka, awilanaka.

5 Lakirapxsnawa uywanakana tansapatjama.



5. Utana awkinakasampi jivasana uywanakasa tuqita lakiraña lip'ichininaka, phuyuninaka, phuqachapxañäni.

Lip'ichininaka	Phuyuninaka
 <p>.....</p>	 <p>.....</p>
<p>.....</p>	<p>.....</p>
<p>.....</p>	<p>.....</p>



Aymarata akhama arunakampi arsuña yatichsituwa.  
Lakirapsnawa, lip'ichininaka phuyuninaka, ...

# Uywanaka lakiwasina sallqa uywanaka uñt'apxañäni



¿Kunsa yatiqapxañänixa?

Sallqa uywanakata aruskipapxañäni uñt'añataki.

## Sallqa uywanaka uñt'apxañäni



2 Qamaqi, taruka, wari, wisk'acha, jararankha, asiru, p'isaqa, kunturi, kiwiya, añuthaya, suri.

1 ¿Kuna sallqa uywanakasa qulluna utjixa?

3 ¿Kuna sallqa uywanakasa pampana, qutana utjpachaxa?

4 Wallata, jamachi, liqiliqi, k'itula, un kaylla, chawlla, jamp'atu, asiru, laq'u, pilpintu...



## 1. Maya warurt'a ist'apxañäni, kikiya warurt'añataki.



### Layqa phichhitanka

Layqa phichhitanka kunsa larch'ukistha munirijampisa silusa mantayistha. (kuti)

Allphachuskirikta juqunkaskiriktha Munirija jutaspä kallchaltawxiriktha. (Kuti)

Wisk'achaskirita jaqinkaskiriktha Munirija jutaspä kuyt'awxiriktha. (kuti)

P'isaqaskirikta qullunkaskiriktha Munirija jutaspä p'isp'is sawxiriktha. (kuti)



Akhama arunakampi arsuña yatiqañäni.

Sallqa uywanaka uñt'apxañäni, ...



## 2. Qullu tuqinkiri sallqa uywanakatha aruskipapxañäni.

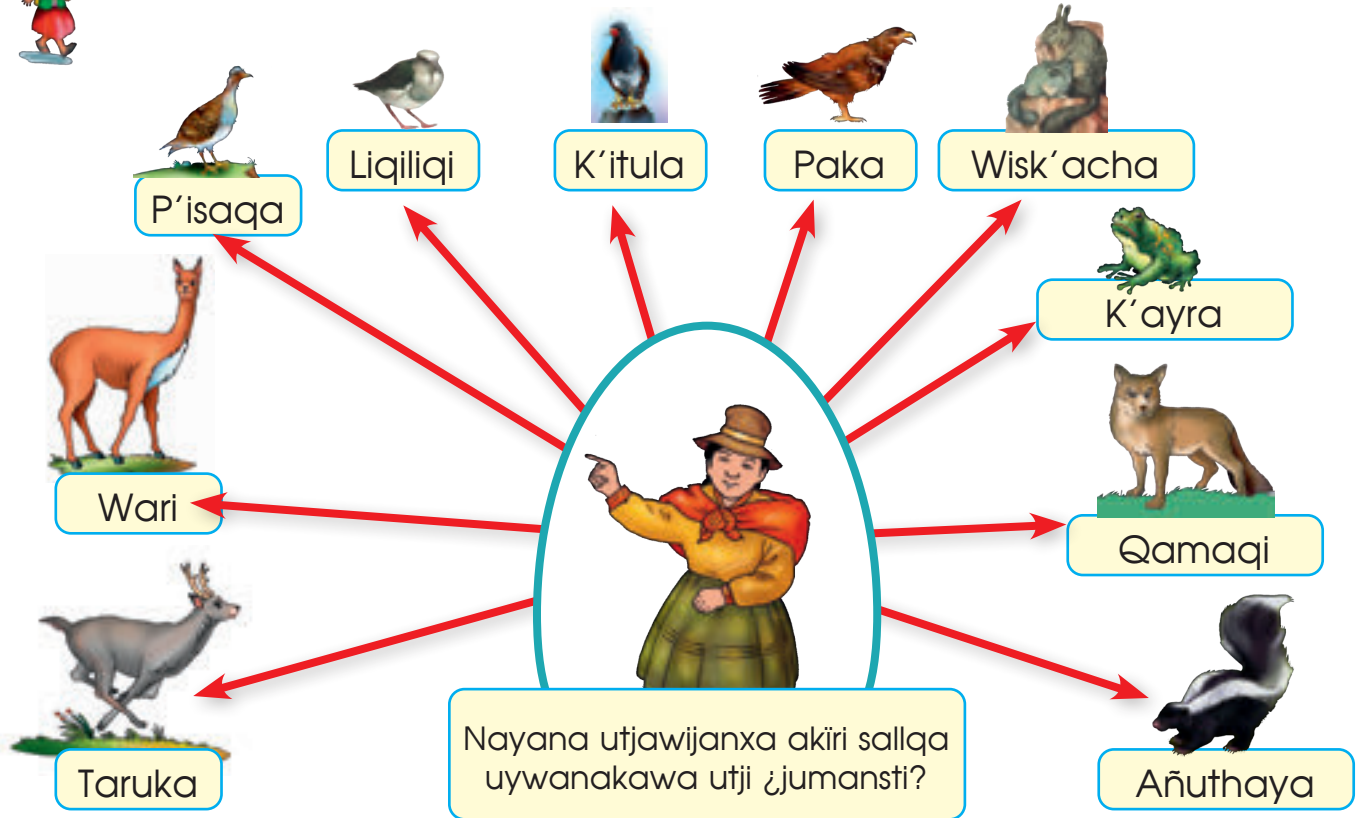

## 3. Utjawimanxa ¿kawkiri sallqa uywanakasa utjixa? Ukana jakisiyapxañäni.

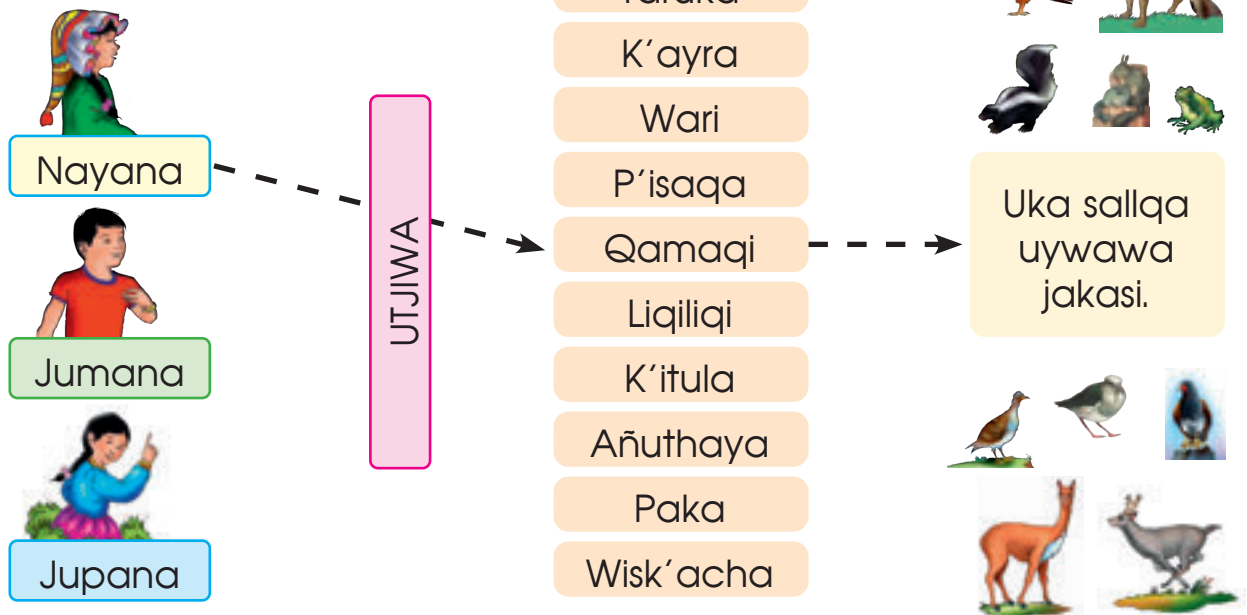

Akhama arunakampi arsuña yatigañäni.

Nayana, jumana, jupana, utjiwa, ...





#### 4. Tataru jiskht'añani kunjamsa sallqa uywanakaxa jakasipxi.

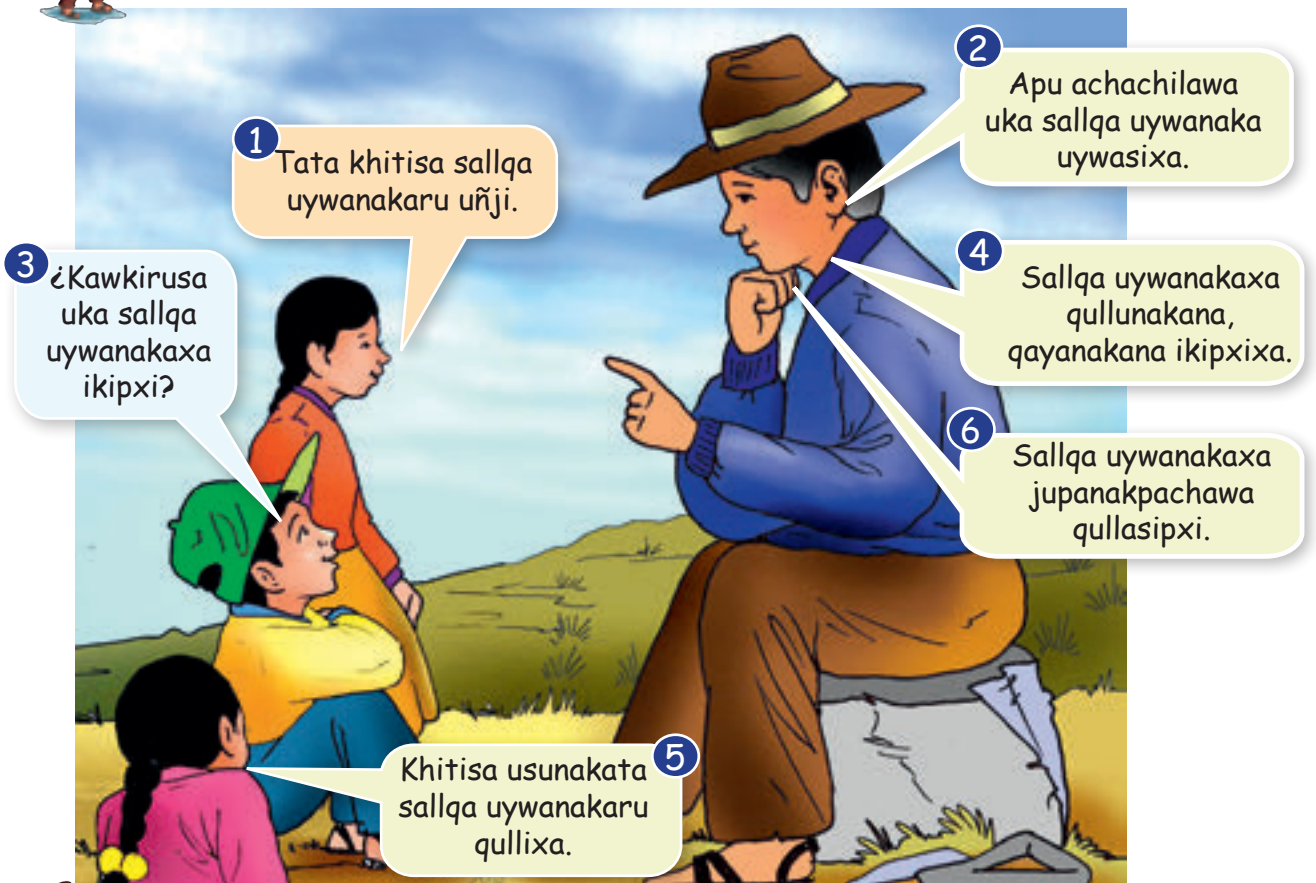

#### 5. Utana wilamasinakasampi aruskipasa jiwasana utjawisana sallqa uywanaka jamuqañani.

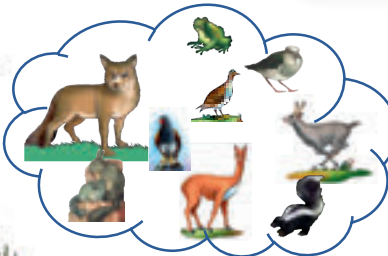
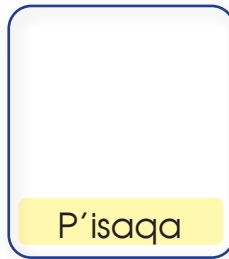

Akhama arunakampi arsuña yatichsituwa.  
Sallqa uywanaka jamuqsuña.

# Yatiqatasanaka uñacht'ayapxañäni



## ¿Kunjamsa yatiqatasa uñacht'ayapxañänixa?

Yatiqatasa sapa mayni amtapxañäni, ukata akhama  sich'impí sich'intapxañäni.

Kunanaksa yatiqatatxa uka uñakipaja	Janirawa yatiqkti 	Yatiqawtha 
1. Utana uñt'ata uywanakata aruskipapxañäni.		
2. Uñt'ata utjiri uywanakata aruskipapxañäni.		
3. Uywanaka uñt'añani qhawqha paxsitsa mirixa.		
4. Uywanaka alasiña, alxaña yatipxañäni.		
5. Uywanaka kasta kasta lakiña yatipxañäni.		
6. Sallqa uywanakata aruskipañäni uñt'añataki.		



## ¿Kunsa lurapxañänixa? T'awranaka tiñiña/ juñinaka samichaña yatiqapxañäni.

### T'awra/juñi tiñiña



## 1. ¿Kuna yänakasa wakisi t'awranaka tiñiñatakixa?



Putuku,  
phuku.



Juñinaka, lata  
kajuna



sulphirinanaka



Qullpa,  
limuna  
sillp'inaka



## 2. Juñinaka tiñiña yatiqapxañäni.

1. Nayraqataxa uma phukuru **wallaqiyaña**.



2. Wallaqita amaru sulphirinanakampi **warantaña**.



3. Ukatxa ukaru juñinaka **tiñiraña**.



4. Wañsuyawasina tiñitha juñinaka **khiwiraña**.



5. Chusinaka tilantawasina **sawuña**.





### 3. Yatiqiri masinakasampi wilamasisana sawutanakapa uñ'apxañäni.

1. Nayraqataxa sawuta isi luririnakjamawa amuyapxañäni.



Sapa mayniwa amuyasiñani luratasa aruskipañataki.



2. Panini paniniwa luratasatha aruskipapxañäni.

1

Nayraqataxa uma phukuru wallaqiyaña.



2

Wallaqita amaru sulphirinampi warantaña.



3

Ukatxa ukaru juñinaka tiñiraña.



4

Wañsuyawasina tiñitha juñinaka khiwiraña.



5

Chusinaka tilantawasina sawuña.



6

Sawuta chusinakampi janasiña.

7

T'AQA

# Satañampitha, mallkiñampitha aruskipapxañäni



¿Kunjamsa utjawina yapuna achuqayaña uñjasipxtanxa?  
¿Kuna uywanakampisa yapunaka yapuchasisipktanxa?



# Jathanaka yapuchañataki uñt'apxañani



¿Kunsa yatiqapxañanixa?

Suma jathanaka satañataki uñt'apxañani.

1

Tata, ¿Kunjama jathanakampisa yapu satastaxa?

Uñt'apxañani jathanaka tuqita

2

Wali suma jathanakampi yapuchastha.

6

Jiwra, awina, yarana, qañiwa, tiriwu, tarwi, ...

3

¿Kuna pachansa ch'uqi satañaxa?

4

Ch'uqixa: nayra, taypi, qhipa pachanakawa satañaxa.

5

¿Kuna achunakasa phawaña?



1. Maya jawari ist'apxañani, kikipa jawar'añataki.



**Pampana Utjasiri  
(jarawi)**

Nayaxa pampana utjasirithwa,  
Uywanakampi chika,  
Thayampi, juyphimpi chika,  
Nayawa pampana utjasiri jilatatxa.  
Yapunakampi chika sarnaqasiri,  
Uywanaka uywachasiri,  
Nayawa pampana utjasiri,  
Nayawa manq'anaka manq'achiri.



**Akhama arunakampi arsuña yatiqañani.**  
Jiwra, awina, yarana, qañiwa, tiriwu, tarwi, ...



## 2. Awicharu yapu yapuchañxata jiskht'apxañäni.

4 Wawanaka, akiri achunakawa sataña: ch'uqi, apilla, isañu, ulluku, jawasa.

1 Awicha, ¿kuna yapunaksa Ayllusana yapuchasipxthana?

3 Awicha ¿kuna achunakasa phawaña?

4 Wawanaka, akiri achunakawa phawaña: awina, tiriwu, siwara, jiwra.



## 3. Arunaka thaqt'asisa jakisiyañäni.



Achunakaxa akhama yapuchañawa

ch'uqixa

ullukuxa

apillaxa

jiwraxa

qañiwaxa

jawasaxa

phawaña

sataña



**Arunaka thaqt'asa, akhama arunakampi arsuña yatiqañäni.**

**Phawaña, sataña, phawaña~~xa~~, sataña~~xa~~.**



#### 4. ¿Kuna yänakampisa yapu satapxsnaxa?



2 Yunta turumpi jawasaxa sataña.

1 Satañatakixa pachamamaru luqtaña.

3 Uysumpi laq'achañaxa.

4 Wanumpiwa satañaxa.

5 Tarakturampixa awinawa qaraña.



#### 5. Awkimpí, taykampi utana sataña achunaka tuqita aruskipapxañani.

Akiri achunakaxa satañawa.



Apilla



Ulluku



Ch'uqi



Alwirija



Isañu



Jawasa



Akhama arunakampi arsuña yatiqañani satañataki.

Ch'uqi, ulluku, apilla, isañu, jawasa, alwirija.



# Phawaña achunakampi phawapxañäni



¿Kunsa yatiqapxañänixa?

Phawaña achunaka qarañataki uñt'apxañäni.

## Phawaña achunaka qariri uñjañani

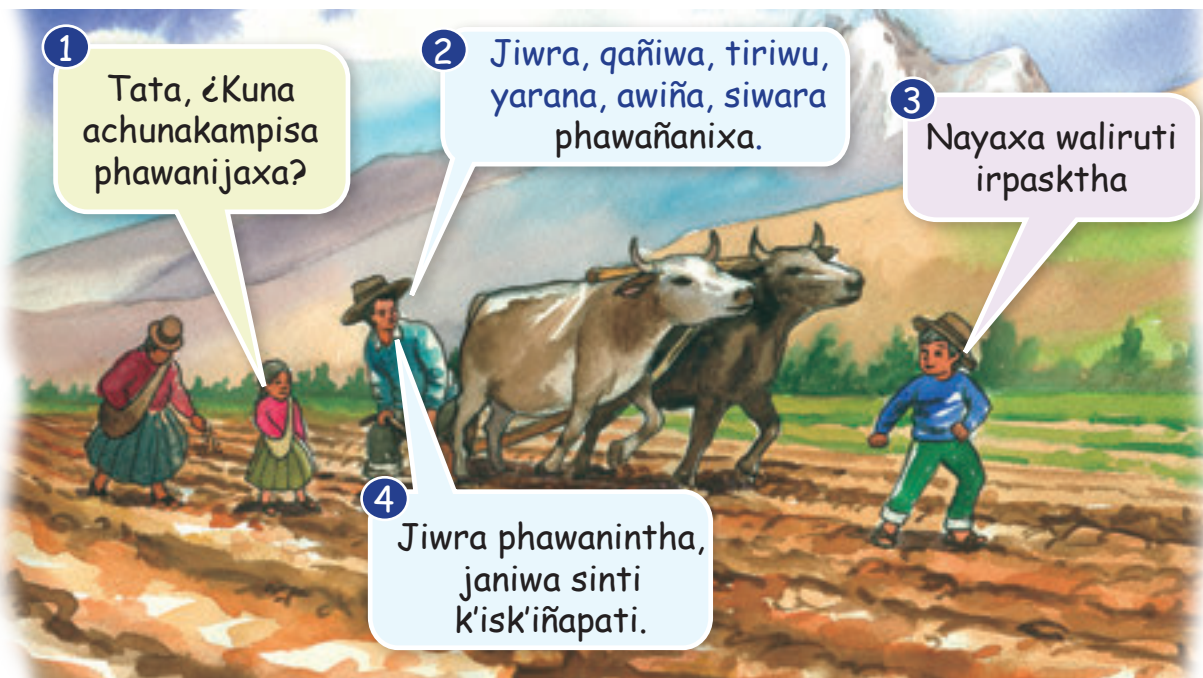

### 1. Maya warurt'a ist'apxañäni, kikiya warurt'añataki.



#### Qañiwa phawiri sarañäni

#### Kuna kamachisa kamichitu - Wirsu

Awkija taykaja, amtasipxi,  
Qañiwa phawaña amtasipxi, (kuti)  
Yanapirisa, jutaniwa.  
Taqi chuymampi yanapt'iri. (kuti)  
Jiliri tatasä, purinxiwa  
Pachamamarusa luqtaniwa, (kuti)  
Kuka istallasa wakicht'ata,  
Suma llamp'usa, wakicht'ata. (kuti)  
Jank'aki, jank'aki sarañäni  
Jiwra phawiri, sarañäni, (kuti)  
Jathanakasa apt'asita,  
Yunta turusa jiskht'asita. (kuti)



## 2. Achunaka kunjama lurañasa ukarjama jakisiyañäni.

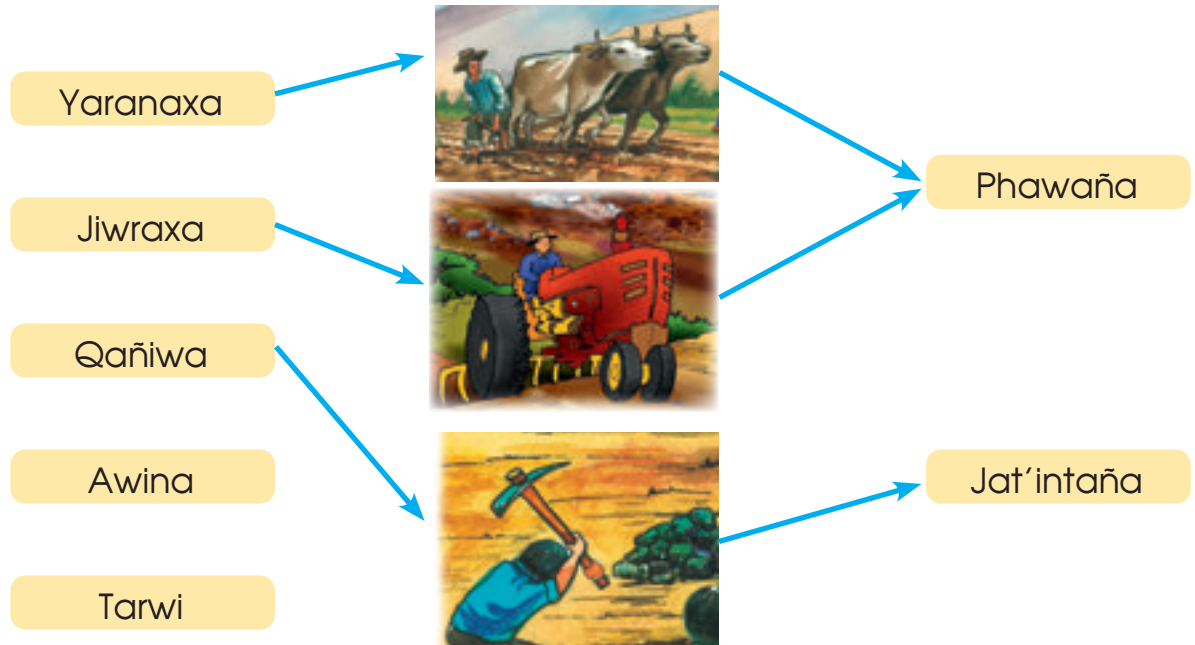

## 3. Yatirimpi aruskipapxañäni ¿Kunjamasä achunaka phawañaxa?

1 Tata, ¿kunjama uraqirusa achunaka phawañaxa?

2 Achunaka qhanuna uraqiru phawañawa.

3 Tata, ¿Kunasa qhanunaxa?

4 Qhanuna uraqixa uñt'atawa qallpa uraqi, ukaxa pasiri marana ch'uqi satatawa.



#### 4. Ist'ata arunakampi jiwaspura arsupxañäni.

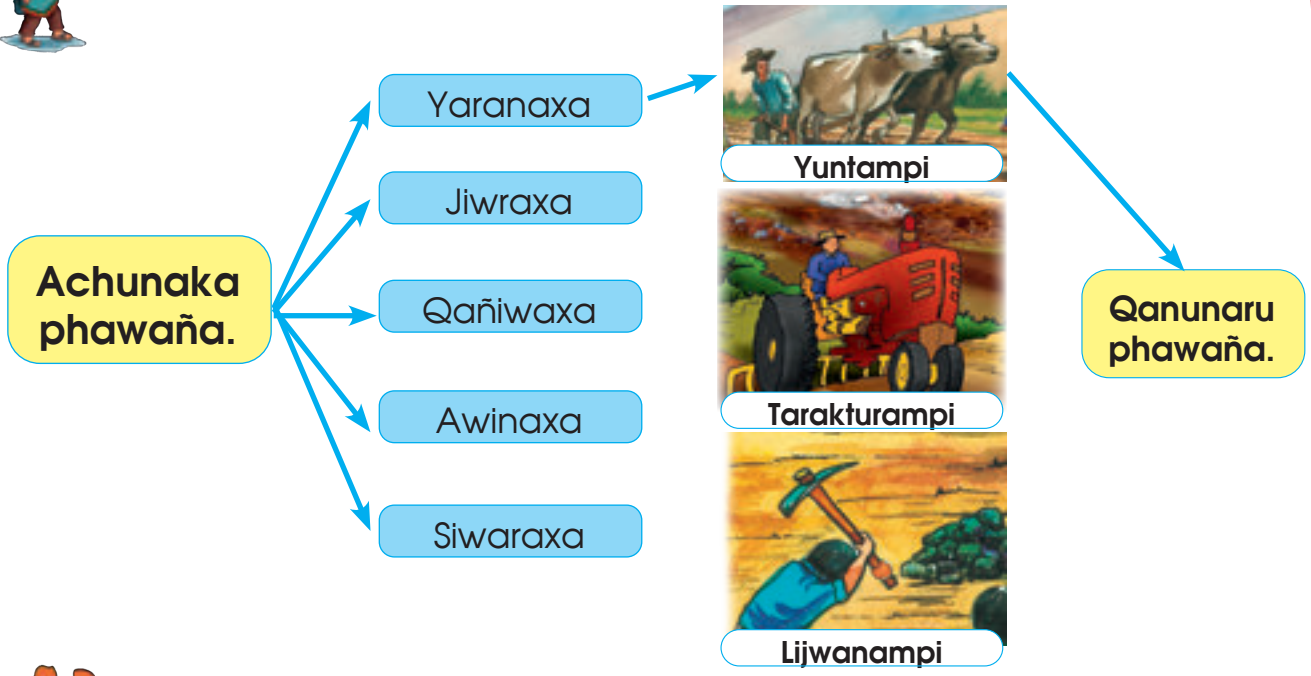

#### 5. Phawañataki jiwra achunakaxa kunaymanawa utji.



**Akhama arunakampi arsuña yatiqañäni.**  
 janq'u jiwra, q'illu jiwra, wila jiwra, quytu jiwra, ...

45

YATIQA

# Ch'uqinaka kasta kasta satapxañäni



¿Kunsa yatiqapxañänixa?

Chuqinaka pachaparu sataña yatiqapxañäni.

## Ch'uqinaka satañataki uñt'apxañäni

2

Uywasipxthwa: ch'iyara imilla, qumpi, janq'u imilla, waka ñuñu, pirwanita, luk'i ch'uqi...!

1

Kullaka, ¿kuna kasta ch'uqinaksa uywasipxtasti?

4

Saya ch'uqinaka satañaxa, jani juyphiñapataki.

3

¿Kuna kasta ch'uqinakasa qulluru satañaspha?



## 1. Maya warurt'a ist'apxañäni, kikipa warurt'añataki.



### Ch'uqi satiri sarañäni



Wirsu Kuna kamachisa kamichitu - wirsu

Awkija taykaja, amtasipxi,  
Ch'uqi sataña amtasipxi, (kuti)  
Yanapirisa, jutaniwa.

Taqi chuymampi yanapt'iri. (kuti)

Jiliri tatasa, purinxiwa

Pachamamarusa luqtaniwa, (kuti)

Kukasa, istallasa wakicht'ata,

Suma llamp'usa, wakicht'ata. (kuti)

Jank'aki, jank'aki sarañäni

Chúqi satiri, sarañäni, (kuti)

Jatha ch'uqisa ampt'asita,

Yunta turusa jiskht'asita. (kuti)



## 2. Jatha ch'ujinaka wali suma uñt'apxañäni.



Wank'u sullu



Ch'iyara imilla



Janq'u imilla



Wayru



Qumpi



Parqu



Chikilla



Wila imilla



Ch'aska



## 3. Ch'ují satañatakixa ¿kuna yänakasa wakisixa uka uñt'apxañäni?



Yunta turu



Jatha ch'ujinaka



Taraktura



Wanu



Ch'ují satañataki



Uraqi



#### 4. Yatirimpi chuqi satañxata aruskipapxañäni.

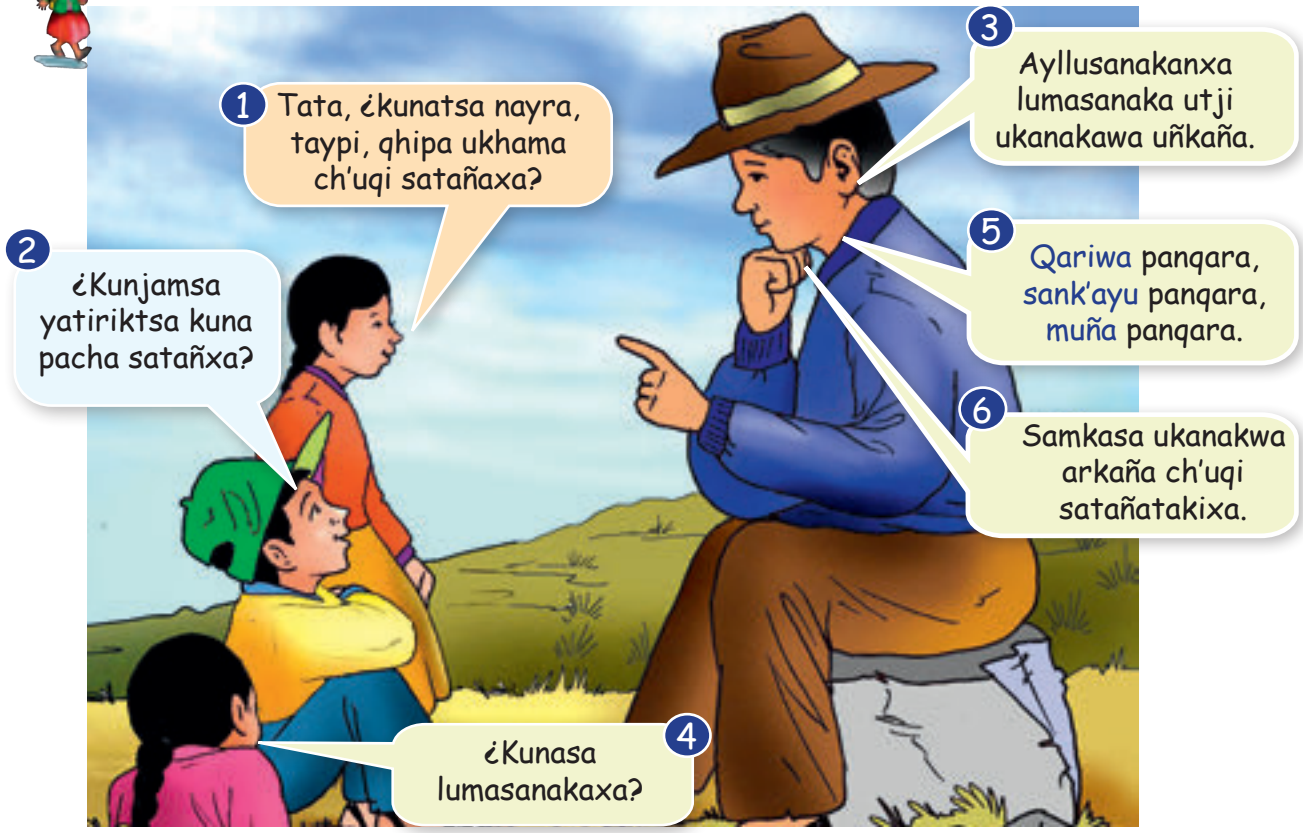

#### 5. Utasana jiskht'asisa akiri lumasa jamuqanaka kuna achu satañatakisa uñkapxi ukampi irpthapipxañäni.



Sank'ayu



Qariwa



Salliwa



Kanlla



Ch'uqi



Jiwra



Jawasa



Apilla

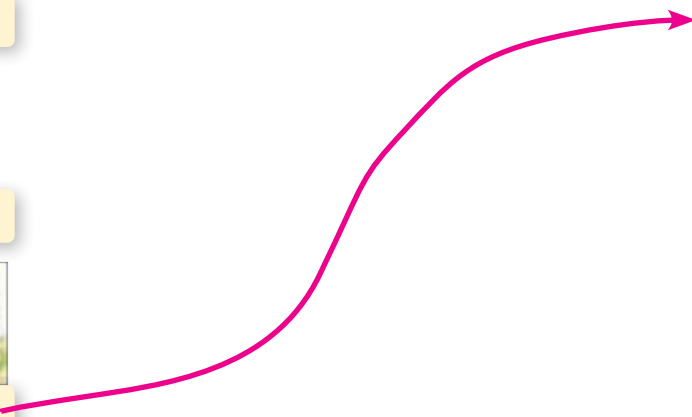

# Ch'uxña alinaka mallkiña yatxatapxañäni



¿Kunsa yatiqapxañänixa?

Chuxña alinaka mallkiñatha yatxatapxañäni.

## Ch'uxña alinaka mallkiñxata aruskipapxañäni

1 ¿Kuna ch'uxña alinakasa ayllusana mallkiñaspha?

2 Siwulla, llachuja, ajusa, witoraja, ukanakawa mallkiña.

3 ¿Kawkirusa ch'uxña alinakaxa mallkiñaspha?

4 Wirta uyunakaru, junt'u uyunakaruwa mallkiñaxa.



### 1. Maya warurt'a ist'apxañäni, kikipa warurt'añataki.



#### Alasiri sarañäni

Irpsitalla wayt'asitalla  
Rikuwana uta tuqiru  
Alxirinakasa suyasiniwa  
Achunaka alxañataki.  
Jina sarañani, jina sarañani  
Chuxña alinaka alasiri  
Jina sarañani, jina sarañani  
Rikarunaka alasiri.



## 2. Juyphi pachana utjaña utana ¿Kuna chuxña alinaksa mallkipsnaxa?

1 ¿Kuna achunaksa aka utaru mallkipxsnaxa?



3 ¿Janiti juyphixa katkaspaha uka utanxa?

2 Mallkipxsnawa: tumati, siwilla, llachuja, ajusa, witraxa...

4 Janiwa juyphintkaspata iwali junt'uwa!



## 3. Ch'uxña alinaka uñt'apxañani.



llachuja



siwilla



tumati



sanawriya



Apiyu



pirijila



ripuyllu



asilja



**Akhama arunakampi arsuña yatiqañani.**  
Ch'uxña alinakaxa: llachuja, siwilla, pirijila, ajusa, ...





#### 4. Chuxña alinaka Juyphi pacha utjaña utana mallkipxañäni.



Ilachuja



siwulla



tumati



sanawriya



Apiyu



Juyphi pacha utjaña utana - MALLKIPXAÑÄNIWA



asilja



pirijila



ripuyllu



#### 5. Utana awki taykaru jiskht'asa phuqachpaxañäni kuna ch'uxña achunakasa mallkiña

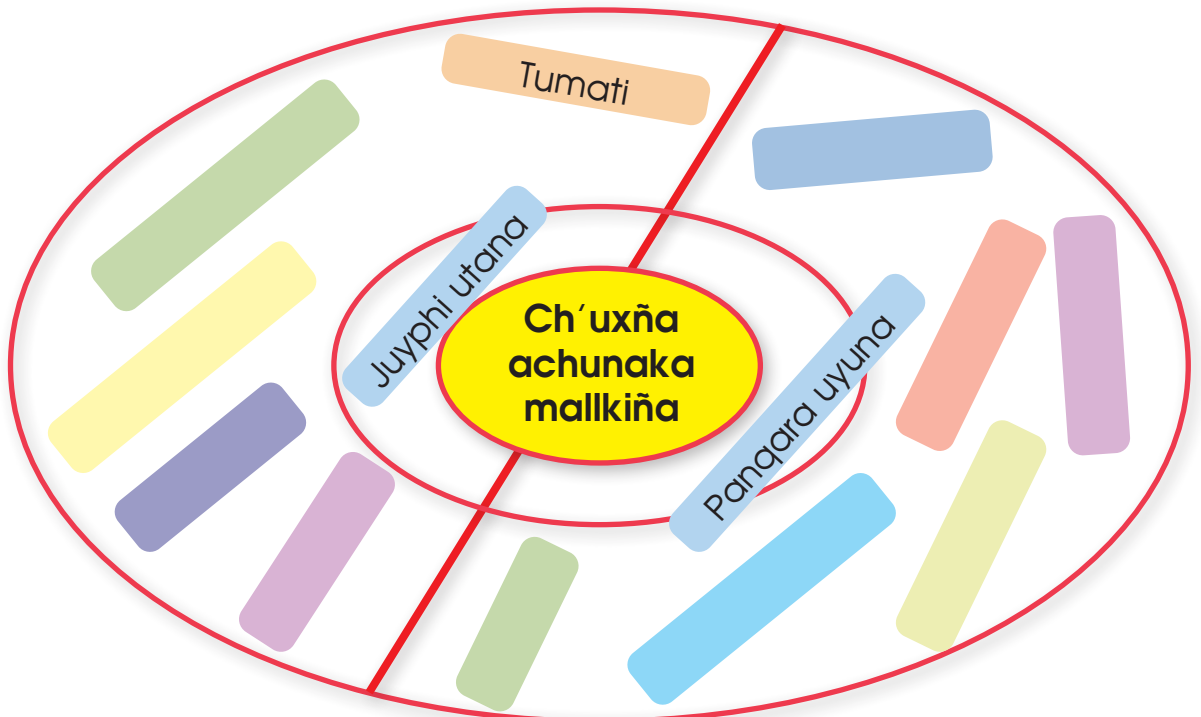

47

YATIQA

# Ch'uxña muxsa puqutanaka mallkipxañäni



¿Kunsa yatiqapxañänixa?

Chuqinaka pachaparu sataña yatiqapxañäni.

## Muxsa puqutanaka mallkiña yatiqapxañäni

1 ¿Kuna muxsa puqutanaksa achuqayapsnaxa?

2 Fresa, ciruela, mansana, apinquya, tunasa, awaymantu.

3 ¿Kunjamasa juyphi pachana utjaña utana mallkiñaxa?

4 Kunjamati mallkiña chuxña alinaka kikipakiwa.



### 1. Maya warurt'a ist'apxañäni, kikipa warurt'añataki.



#### Muxsa Achu Sataña (Awki awki - Wirsu)

Muxsa achunaka mallkiñaxa,  
Wali sumallawa. (kuti)

Pachamamata pampacht'asisa,  
Nayaxa yapuchtha. (kuti)

La; la; la;

Nayaxa yapuchtha. (kuti)





4. ¿Kuna ch'uxña muxsa puqutanaksa juyphi pachana utjaña utaru mallkipxsnaxa?



awaymantu



Aka utaru ch'uxña muxsa puqutanaka mallkipxsnaxa.



ciruela



manzana



fresa

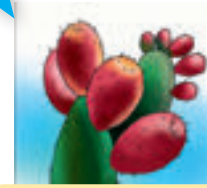

tunasa



5. Tataru utana jiskt'apxañani, kuna ch'uxña muxsa puqutanaksa mallkipxtana uka phuqachapxañani.

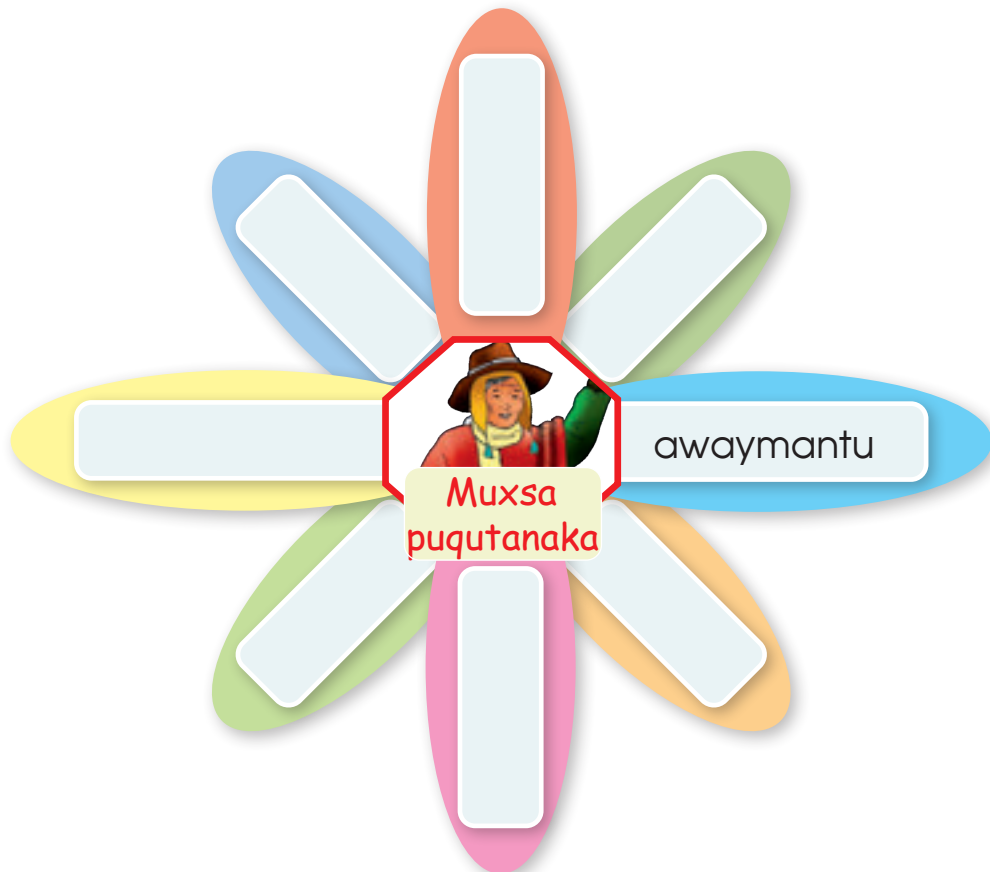



¿Kunsa yatiqapxañänixa?

Quqanaka mallkiñataki yatiqapxañäni.

### Quqanaka mallkipxañäni

2 Qulli, yukalitu, sipirisa, pinu, lampaya, qantuta, pangara quqa...

1 ¿Kuna mallkiña quqanaksa uñt'apxtaxa?

4 Janiwa, éyatichitt'itasmati?



3 Wirta uyunakaru, junt'u uyunakaruwa mallkiñaxa.



1. Maya warurt'a ist'apxañäni, kikiapa warurt'añataki.



### QUQA MALLKINA

Jawari

Maya uruxa pani jilasullkawa maynixa Qulli  
sutini mayniraki Pinu sutini jakisipxatayna,  
Qullixa wali llakitawa sarakina kamachskakiñäni  
wilamasinakasaxa q'ala jiwaratäxiwa, sasa.  
Ukhamawa Pinuxa sarakina jilaku janiwa  
jakañaxa jiwasataki utxiti sasa.  
Jupanakaxa panipawa qhumant'asiwasina  
sapaxatayna jaya marakaru sarxañäni  
sasa, ukatwa quqanaka jani ayllunakana  
jichhurunakana utjxarakiti.



## 2. Qutuchasiwasinxá, quqa mallkiña tuqitha aruskipapxañäni.

Jiskht'awinaka ullasa aruskipapxañäni.

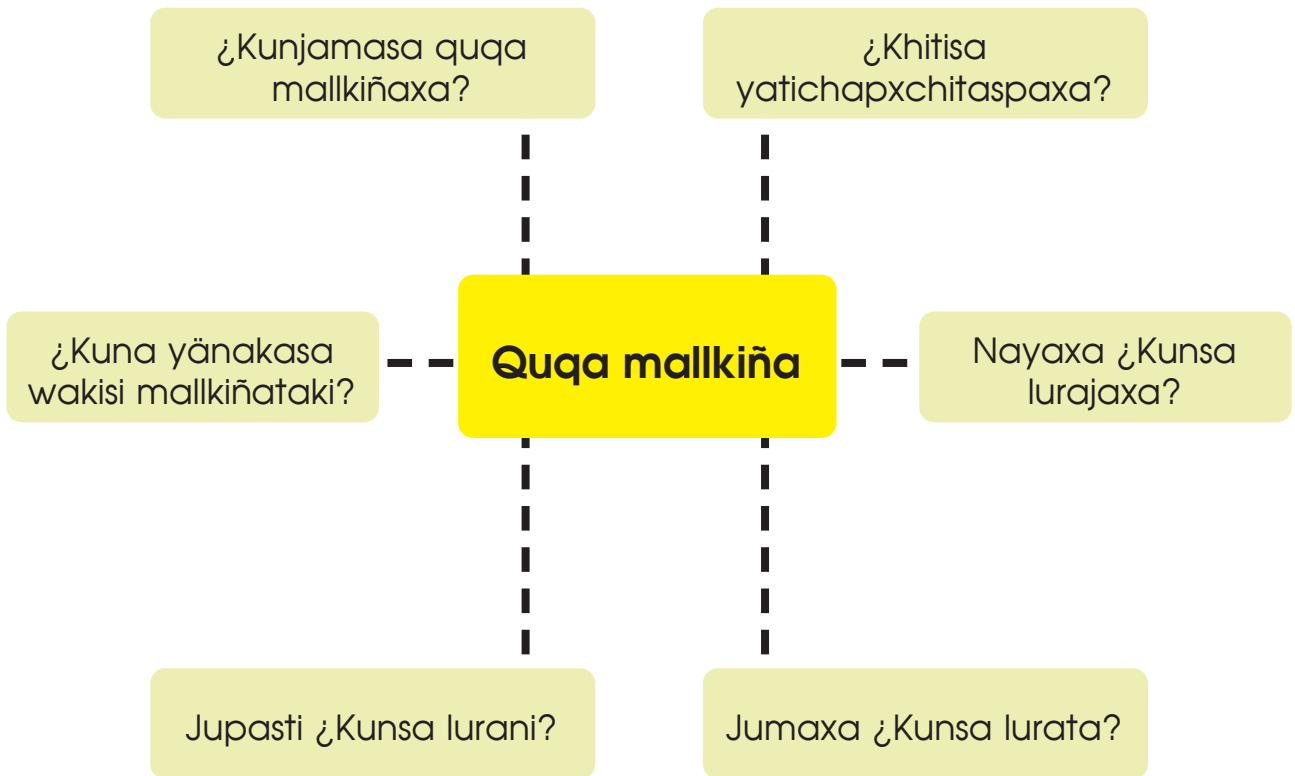

## 3. Yatichiriru wakisiri ixwanakapa ist'apxañäni.

The illustration shows a man in an orange jacket standing and speaking to two people seated at a desk. A speech bubble from the man says "Wawanaka, **ist'apxita!**". Four numbered callout boxes point to different parts of the scene:

1. Taqi mayniwa utanakamana awkinakaramaru jiskht'anipxätha.
2. Yänaka apanipxätha quqa mallkiñataki.
3. Uywa wanunaka apanipxätha.
4. éKawkitsa quqanaka jakipxsnaxa mallkinataki? Uka jiskht'anipxäta.



#### 4. Yatiqiri masinakasampi quqanaka mallkiñxata jakisiyapxañani.

¿Kawkinakarusa quqanaka mallkipxsnaxa?



sipirisaxa

**Pampanakaru** mallkiñawa.

qullixa

**Uyunakaru** mallkinawa.

yukalituxa

Qullu **parqinakaru** mallkiñawa.

qantutaxa

Jawira **lakanakaru** mallkiñawa.

Panqara quqanakaxa

Uta **qawayanakaru** mallkiñawa.



#### 5. Utana wilamasinakasampi aruskipapxañani ¿kawkinakarusa quqanaka utjawisana mallkisipxtanxa?



¿Kuna quqanaksa mallkisipxtana utjawisanxa?



Tatajaxa

Iwkaliptu qullu parkinakuwa mallkisipxta.



Kullakajaxa

SIWA





Masijaxa

# Yatiqatasanaka uñacht'ayapxañäni



## ¿Kunjamsa yatiqatasa uñacht'ayapxañänixa?

Yatiqatasa sapa mayni amtapxañäni, ukata akhama  sich'impí sich'intapxañäni.

Kunanaksa yatiqatatxa uka uñakipaja	Janirawa yatiqkti 	Yatiqawtha 
1. Jathanaka yapuchañataki uñt'apxañäni.		
2. Phawaña achunakampi phawapxañäni.		
3. Kasta ch'uqinaka satapxañäni.		
4. Ch'uxña alinaka mallkiña yatxatapxañäni.		
5. Ch'uxña muxsa puqutanaka mallkipxañäni.		
6. Quqanaka mallkipxaña yatiqapxañäni.		



## ¿Kunsa lurapxañänixa?

Compus sata luraña yatiqaxañäni

### Compus Lurañäni



## 1. ¿Kuna yänakasa wakisi compus sata lurañataki?



K'ullu kajuna

Jilt'a  
sillpiñanaka

Ch'iyara laq'a

Lampilla, uma  
chhixiyaña





## 2. *Compus sata ¿kunjamsa lurañänixa?*

1. Nayraqataxa k'ullu kajunawa wakichañataki **liq'suña.**

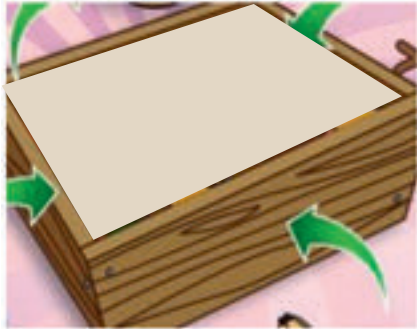

2. Uka kajunaru chikakama ch'iyara laq'awa **warantaña.**



3. Ukatha kajunaru kunaymana sillp'inakampi **phuqayaña.**



4. Ukaruxa umampi sillp'inaka ñusantañapataki **chhixiyaña.**





### 3. Yatiqiri masinakasampi wilamasisana *compus sata* luratanakasata aruskipapxañani.

1. Nayraqataxa compus sata luririnakjamawa amuyapxañani.



Taqiniwa uka luratasa amtasisa amuyapxañani.



2. Panini paniniwa luratasatha aruskipapxañani.

1

Nayraqataxa k'ullu kajunawa wakichañataki liq'suña.



2

Uka kajunaru chikakama ch'iyara laq'awa warantaña.



3

Ukatha kajunaru kunaymana sillp'inakampi phuqayaña.

4

Ukaruxa umampi sillp'inaka ñusantañapataki chhixiyaña.



5

Uka compus sata apsuñani mallkiñataki.

6

Quqa alinaka mallkiñaruwa wanuñchañani.



8

T'AQA

# Markasana Jakawipatha Yatxatapxañäni

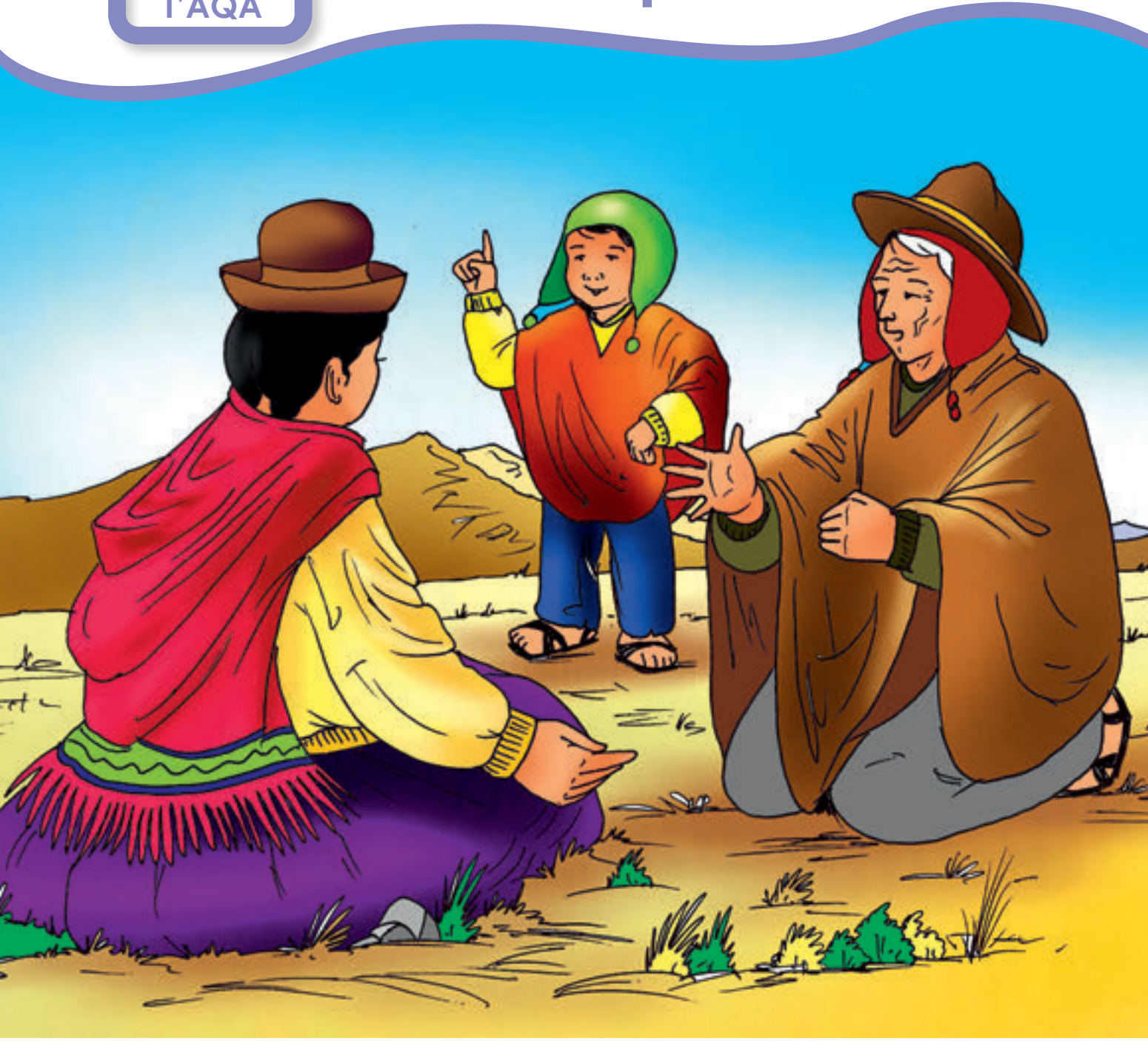

¿Kunjamsa jakawisana sarnaqasiptanxa?  
¿Kunjamsa pampana, markana utjasiptanxa?



# Ayllusana utjawi tuqita yatxatañäni



¿Kunsa yatiqapxañänixa?

Ayllusana utjawinakapa uñt' añataki yatxatapxañäni.

Ayllusana utjawinakapa uñt' apxañäni.



1. Maya warurt' a ist' apxañäni, kikipa warurt' añataki.

## SUNI PAYITA

Suni payitatha mantantha  
aqarapitha punchullani,  
chhullunkhiyatha wiskhullani  
quri ch'uspalla apt'asita.  
Larama qutatha mistuntha  
quri walsallatha purintha,

jumana urumana sipana  
qullqi ñuqiña apt'asita.  
Taqi chuymampi thuqt'asiñani  
ch'iqä tuqiruwa muyt'asiñani,  
taqi chuymampi thuqt'asiñani  
kupi tuqiruwa muyt'asiñani.



Akhama arunakampi arsuña yatiqañäni.  
Mantantha, aqarapitha, chhullunkhiyatha,  
walsallatha; tha.



## 2. Kunanaksa pampa tuqina lurapxatana jakasiñataki uka arunaka thaqt'asa katjawasina muyuntapxañani.

1. YAPU
2. UYWA
3. SAWUÑA
4. UTACHAÑA
5. P'ITAÑA
6. MALLKIÑA
7. SATAÑA
8. QAWAÑA
9. QULLAÑA
10. QULLUNAKA

C	H'	U	Q	I	W	R	J	X	S	A	K'
I	D	T	Y	A	P	U	X	J	H	Y	A
X	S	A	T	A	Ñ	A	S	H	U	C	Y
Q	K	W	R	S	X	Q'	U	U	Y	W	A
U	I	R	I	A	S	A	I	T	A	P'	H
L	S	Q	A	W	A	Ñ	A	A	R	I	A
L	U	S	K	U	W	Ñ	A	C	A	T	K
U	X	L	X	Ñ	W	Y	T	H	N	A	A
N	A	L	U	A	A	T	W	A	A	Ñ	S
A	M	M	A	L	L	K	I	N	A	A	U
K	A	S	T	Y	U	I	W	A	R	S	I
A	I	Q	U	L	L	A	Ñ	A	X	U	Ñ



## 3. Ayllusana lurañaka tuqitha, arunaka thaqt'asisa jakisiyañani.



Nayaxa



Jumaxa

anaktha

awattha

uywanaka

qawta

qullta

yapunaka

lurta

alxtha

sumachtha



Aymara arunaka thaqt'asa, akhama arunakampi arsuña yatiqañani

Anaktha, awattha, qawta, qullta, lurta, alxtha, sumachtha.



#### 4. Ayllusana pachamamaru luqtañawa, suma jakasiñataki.

1 Munata pachamama, jumaru luqt'asinipxma taqi munasiña chuymampi katuqt'asikxita.

4 Yapunaka suma achuqañapataki waxt'aña.

2 ¿Kunathsa luqtaña wakisixa?

3 Pachamamaru uywanaka mirañapataki luqtaña.



#### 5. Awki taykampi utasana, ayllusana suma utjasiña tuqita k'atampi yatxataskakiñani.

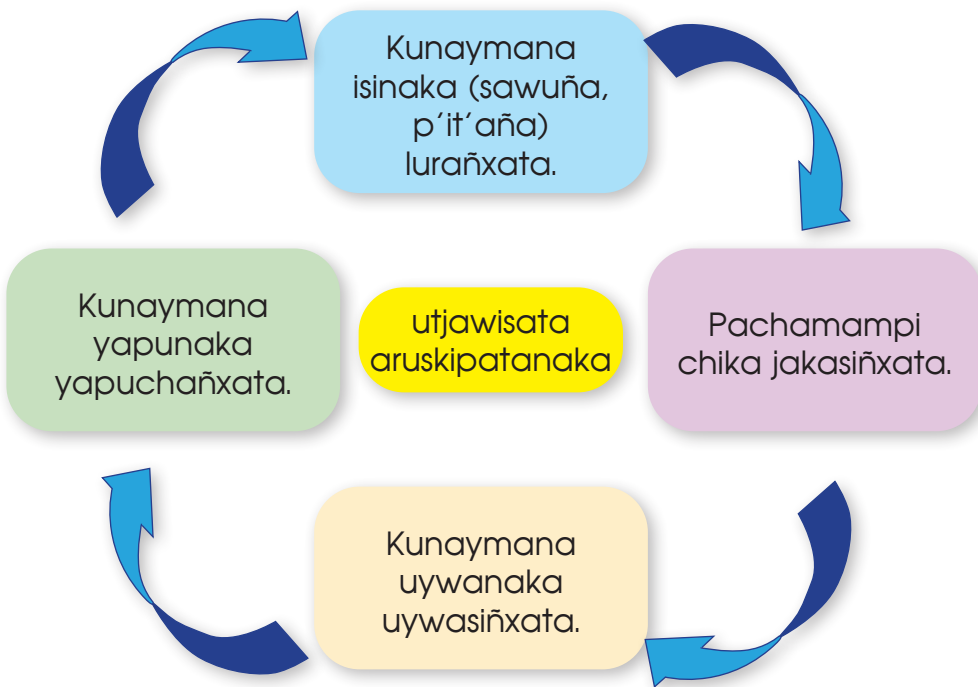

# Markana utjawi tuqita yatxatañäni



## ¿Kunsa yatiqapxañänixa?

Markana utjawinakpa tuqita yatxatapxañäni yatiñataki.

## Aixaña achunaka uñt'apxañäni

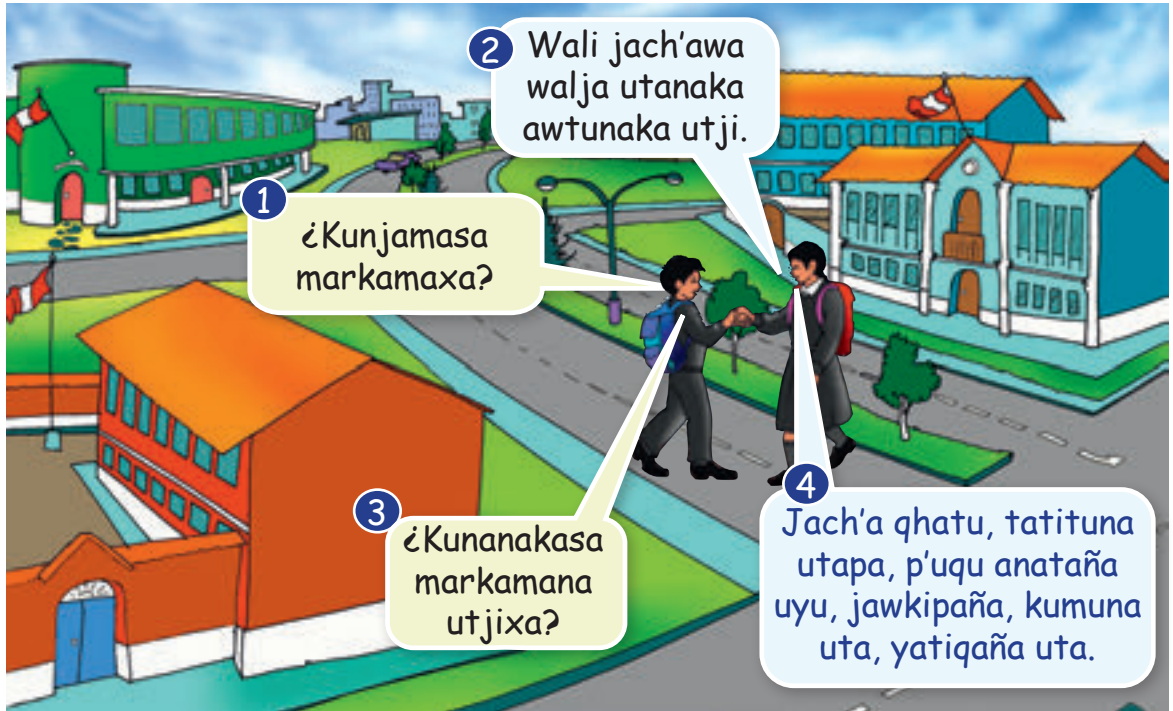

1. Maya jarawi ist'apxañäni, kikipa jarawt'añataki.



## Suma Marka (Jarawi)

Puno suyu marka, apu Asujini, mama Kancharani, mama quta.  
Sumaki uywasipxita jani armasipxistati nayraru sartañataki.  
Jaqinakamasa walja qanlljama ayxti, awtunakasa taqxatasirjama.  
Puno suyu marka, apu Asujini, mama Kancharani, mama quta.  
Chuymama churapxita  
Aka markasa qhispiyañataki wiñaya wiñayäñapataki.



## 2. Ayllusana pachamamaru luqtaña suma jakasiñataki.



1 U T A N A K A



2 A W T U N A K A



3 K A L L I N A K A



4 Q U Q A N A K A



5 P' U Q U A T A Ñ A



6 Y A T I Q A Ñ A U T A



7 K U M U N A U T A



## 3. Jiwasa puraki aruskipañani, kunanakasa markasana utjirinakata.



Markasana utjiwa

Kumuna uta

P'uqu anataña

Yatiqaña uta

awtunaka

kallinaka

utanaka

Yupaychaña uta

Anatañataki

Sarnaqañataki

Utjasiñataki

Q'uchuñataki

Mallkuna irnaqañapataki





4. Ist'ata arunakampi jiwaspura arsupxañäni.

2 Markajana walja utanaka, awtunaka, p'uqu anataña, yatiqaña uta, ukanakawa utji.

1 ¿Kunjamasa markamaxa uka yatt'ayita?



4 Janiwa yapunaka yapuchapkti, uraqisa janiwa utjkiti.

3 ¿Kuna yapunaksa yapuchapxtaxa?



5. Awkinakasaru utana jiskht'apxañäni ¿kunanakasa utji markasana uka sich'intapxañäni? (X)



Juliku

Utanaka	P'uqu anataña	Yatiña uta	Kumuna uta



Ana

Kallinaka	Utanaka	Yatiña uta	P'uqu anataña

# Julikuxa ayllupana sarnaqawipa yatiyi



¿Kunsa yatiqapxañänixa?

Ayllusana sarnaqawipa yatiñataki uñt'apxañäni.

Yulikuna ayllupa uñt'apxañäni



2

Ayllujaxa  
K'ulta  
satawa

1

¿Kuna sutinisa  
ayllumaxa?

4

Kunaymana  
lurawinakawa  
utjixa: yapu luraña,  
uywa awatiña,  
p'itaña, sawuña.

3

¿Ayllumana  
Kunanaksa  
lurapxtaxa?



1. Maya jarawi ist'apxañäni, kikipa jarawt'añataki.



## JULIKU SATATWA Jarawi



Nayawa ch'ullqi wawatha  
suni tuqina utjasiri.  
Thayampi jallumpi chika  
sarnaqasiri.  
Wari qalluta uywani  
Qamaqita anuni.  
P'isaqata wallpani.  
Nayaxa Juliku pampana  
utjasiri, yapumpi uywampi  
chika jakasirithwa.



## 2. Julikuna aylupana luratanakapa yatxatapxañani.

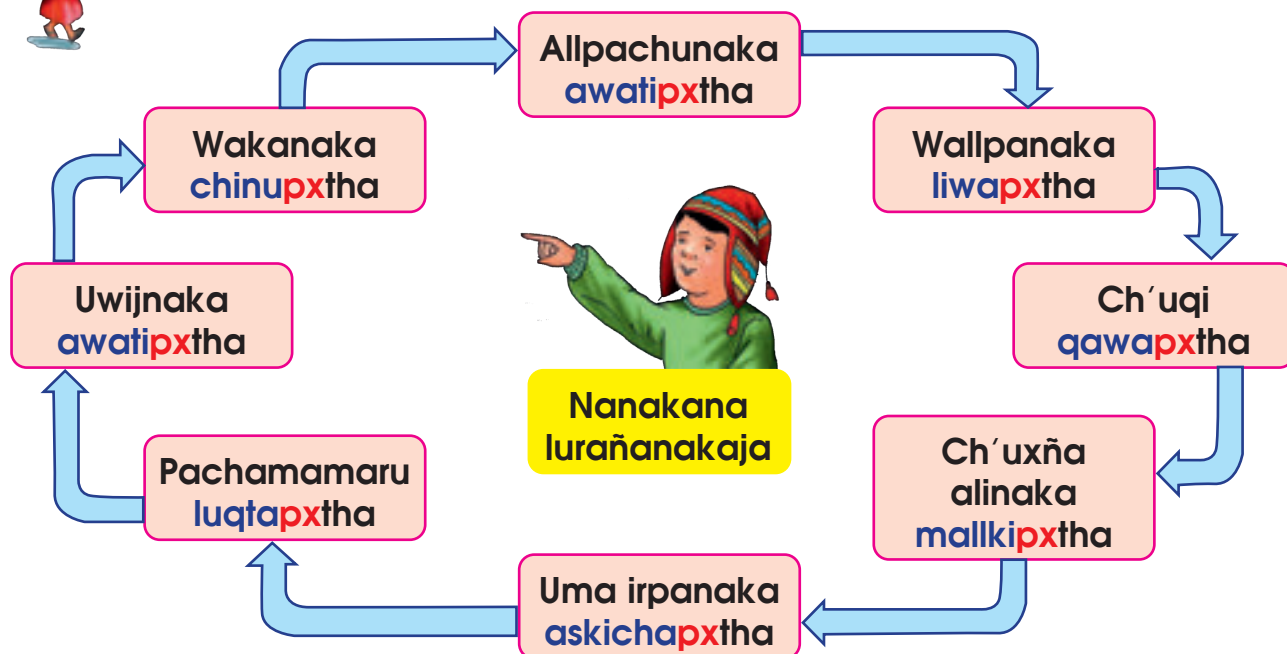

## 3. Yatiña utana utjasiwi tuqita aruskipapxañani.



Utjawisanakasatha

Uywanakasatha



Jakawisatha

Pachamamatha



Akhama arunakampi arsuña yatiqañani.  
Awatipxtha, liwapxtha, qawapxtha, mallkipxtha, ...



#### 4. Jifiri tatampi ayllusana utjawisa tuqita aruskipapxañäni.



#### 5. Awkinakasampi akiri arunaka phuqachapxañäni utjawisa tuqita: cha, wa, ña, xa uka qillqanakampi.

arunaka	→	Phuqachiri <b>cha</b>	→	Phuqachiri <b>wa</b>
uywa	→	uywaja	→	uywama
yapu	→	.....ja	→	.....ma
sawuña	→	.....ja	→	.....ma
P'itaña	→	.....ja	→	.....ma
arunaka	→	.....pa	→	.....sa
uywa	→	uywapa	→	.....sa
yapu	→	.....pa	→	.....sa
yati	→	.....pa	→	.....sa



## ¿Kunsa yatiqapxañänixa?

Markana sarnaqawipa uñt'apxañani yatiñataki.

## Sunilana markapa uñt'apxañäni

1

Markajana qhatupanxa kunaymana kasta kasta mang'anaka alxaña utji, ukana jaqixa k'isimirjamawa aywnaqi, ukatha lunthatawa wali miranti.



2

¿Yatt'ayitasmati kunjamasa markamana sarnaqawipaxa?



1. Maya warurt'a ist'apxañäni, kikiya warurt'añataki.



## Jumapuniwa kutiyanista

Jach'a qhaturu saraskipansa jumapuniwa kutiyanistha. (kuti)

Yatiqaña utaru saraskipansa jumapuniwa kutiyanistha. (kuti)

P'uqu anatiri saraskipansa jumapuniwa kutiyanistha. (kuti)



## 2. Sunilana markapana utjatanakapata arsupxañäni.

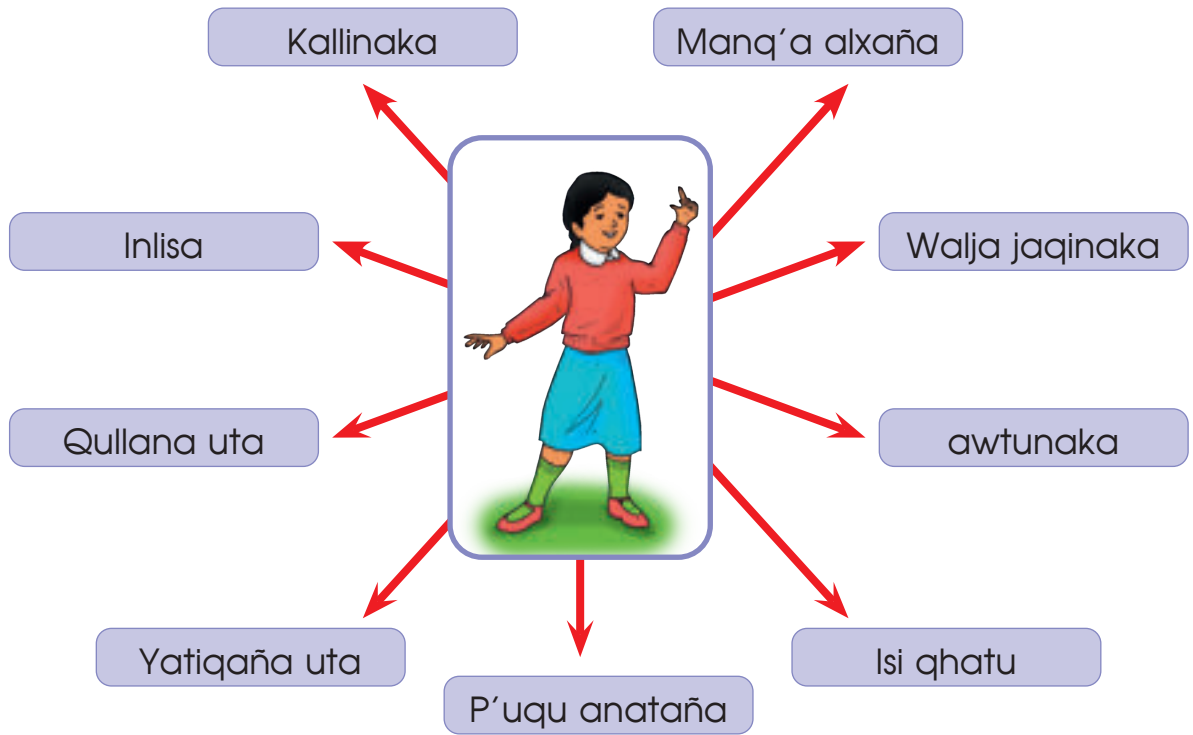

## 3. Sunilana markapana utjawipata amuyt'awasina arunaka jakisiyapxañäni.

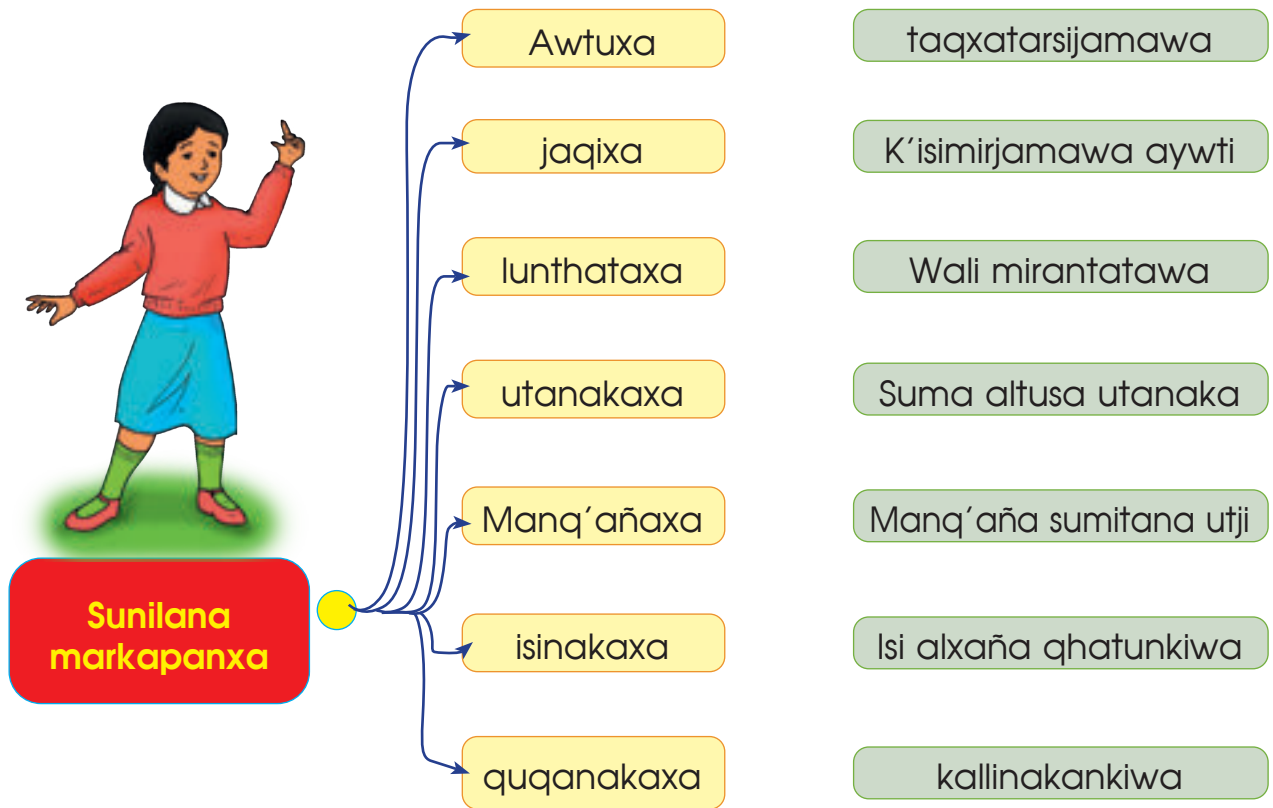



4. Qutuchasiwasinxá, Sunilana markapá tuqita yatiqiri masinakasampi aruskipaxañani.

1 Sunilana markapaxa wali jach'awa.

3 Awtunakasa taqxatasirjamawa siwa.

2 Jaqisa k'isimirjamawa ayjwtaskixa.

4 Utanakasa wali suma altusaniwa.



¡Uñjiri sarapxañani!



5. Utana wilamasinakasampi, Sumitana markapana sarnaqawipata aruskipasa phuqachapxañani.



Kunanakasa Sunilana markapana uka uñt'askakiñani.



# Aylluna thuquwinakapa uñt'apxañäni



## ¿Kunsa yatiqapxañänixa?

Aylluna thuquwinaka yatiñataki uñt'apxañäni .

## Ayllusana thuquwinakapa aruskipapxañäni

1

¿Kuna pachanakansa thuqupxtaxa?

2

Phunchhawinakana, uta utachawina, uywa ch'uawina, panichasiwina, anata phaxsina, ayllusa mara phuqantkiphana.

3

¿Kunatsa anata phaxsina thuqupxtha?

5

Anata phaxsina ¿kuna phusanakampisa thuqupxtha?

4

Yapunaka sumipana thuqupxtha.

6

Pinkillu, tarqa, qinachu, siku ukanakampi.

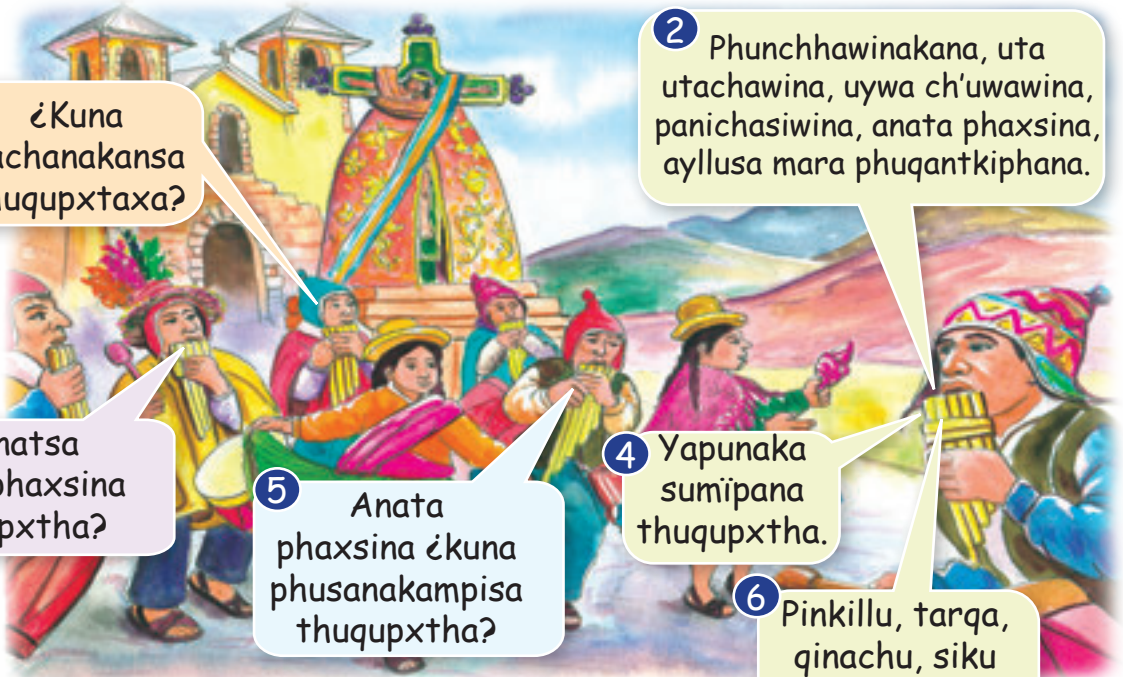

## 1. Maya jarawi ist'apxañäni, kikipa jarawt'añataki.



### Nanaka thuqusipxtha Jarawi



Nanakaxa thuqt'asipxtha pinkilluta, tarqa, qinachu

Anata phaxsina kusionpaxñani

Anata phaxsina kusionpaxñani

Yapunaka sumipana kusionpaxñani.

Pay suma kumpayri  
paysuma kumayri jallaphana  
lurawinakasaxa.





## 2. Jichhaxa yatiqiri masinakampi aruskipapxañäni ayllusana chakana punchhawina arsutanakapa.

1

Kumpayri waliki jutt'awtaxa tuqt'añaniwa.

2

Pay suma kumpayri tatituwa kutt'ayapxatama.

3

Paysuma kumayri askina aptt'aniwtha.

4

Kumpayri akhama khuchiqallumpi, umañanakampi aptt'aniwapxta jaqunt'asiñani.

5

Kumayri akiri puquta chunakakwa aptt'aniwxtha.

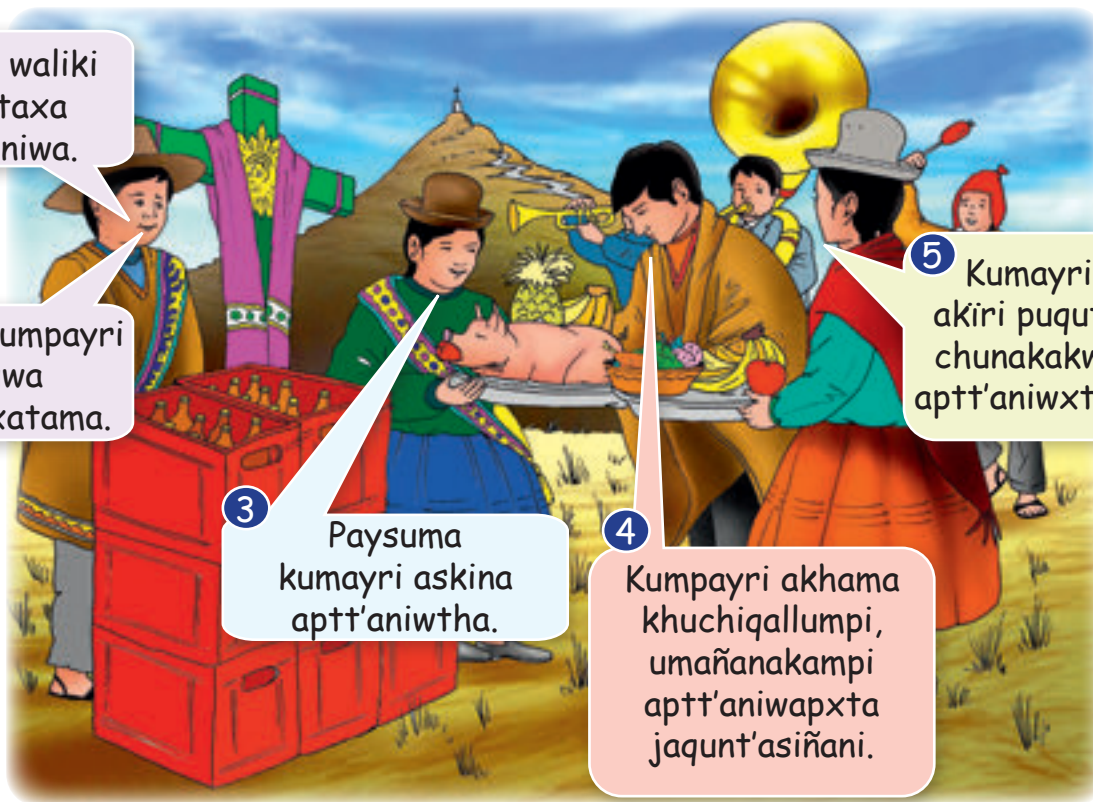

## 3. Ayllusana punchhawinakapa uñt'apxañäni.

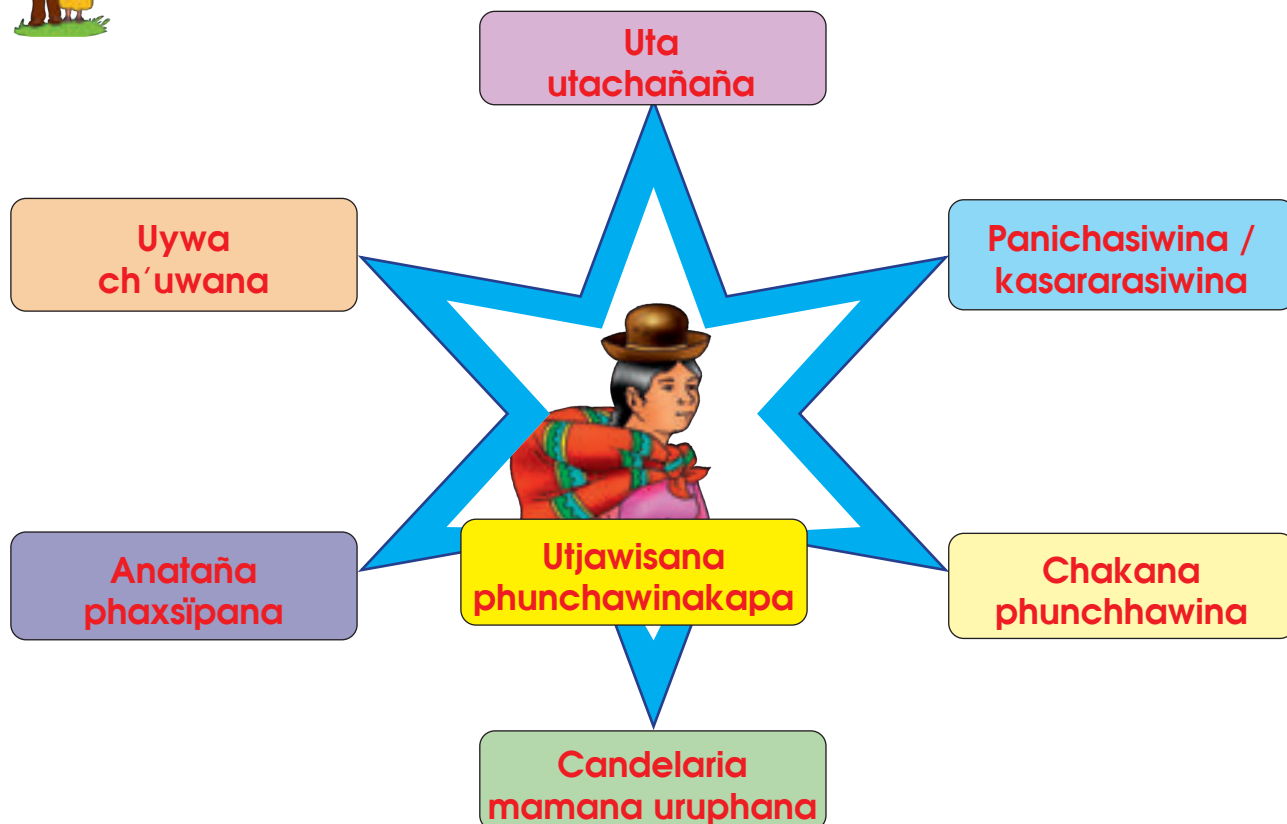



#### 4. Aruskipasa phunchawi sutimpi jamuqampi jakisiyapxañäni.

Uywa  
ch'uwañana

Anataña  
phaxsipana

Uta  
utachañana

Panichasiwina  
/jaqichasiwina

Chakana  
phunchhawina



#### 5. Tataru utana jiskht'apxañani ayllusana phunchawinakapxata ukata jamuqasa phuqachapxañäni.

A collection of empty circles and one octagon for labeling. One octagon contains an illustration of a person in traditional clothing. One circle contains an illustration of a traditional stone house.

# Candelaria mamana phunchhawinakapa yatxatapxañäni



## ¿Kunsa yatiqapxañänixa?

Candelaria mamana phunchhawinakapatha yatxatapxañäni.

## Ayllunakana, markanakana phunchhawinakapa

1

¿Kuna phaxsinsa Candelaria mamana phunchawipaxa?



2

Anata phaxsinkiwa.

3

¿Kuna kasta thuquwinakasa utji?

4

Pampa tuqina thuquwinaka, misti q'aranakana thuquwinakapa.

5

Yatt'ayitasmati pampa kasta thuquwinakatha.

6

ijisa! aymara aylluna thuquwinakapa, qichwa aylluna thuquwinakapa.



## 1. Maya warurt'a ist'apxañäni, kikiya warurt'añataki.



### Candelaria Mama

Awki awki - wirsu

Candelaria mamana phunchawisipanxa (kuti)

Aymaranakasa qichwanakasataqi tuqitha purinipxaraki. (kuti)

La la lal lal la.

Yupaychapxañäni thuqt'awinakampi yupachapxañäni warurt'awinakampi.

Jiwasana sartawinakasampi

La la lal lal la.



## 2. Jichhaxa awichampi *Candelaria* mamana phunchawipa tuqitha aruskipapxañani.

2 Candelaria mamaru aruntiriwa sarapxi.

1 ¿Kunatsa Puno markaru thuquri sarapxi?

4 Walja thuquwinakawa: k'ajilu, uywa ch'uwa, wapululu, chakariru, llamayuri, allphaqa awatiri, wari wawa, ukanakawa.

3 ¿Kuna thuqñanakasa utji?

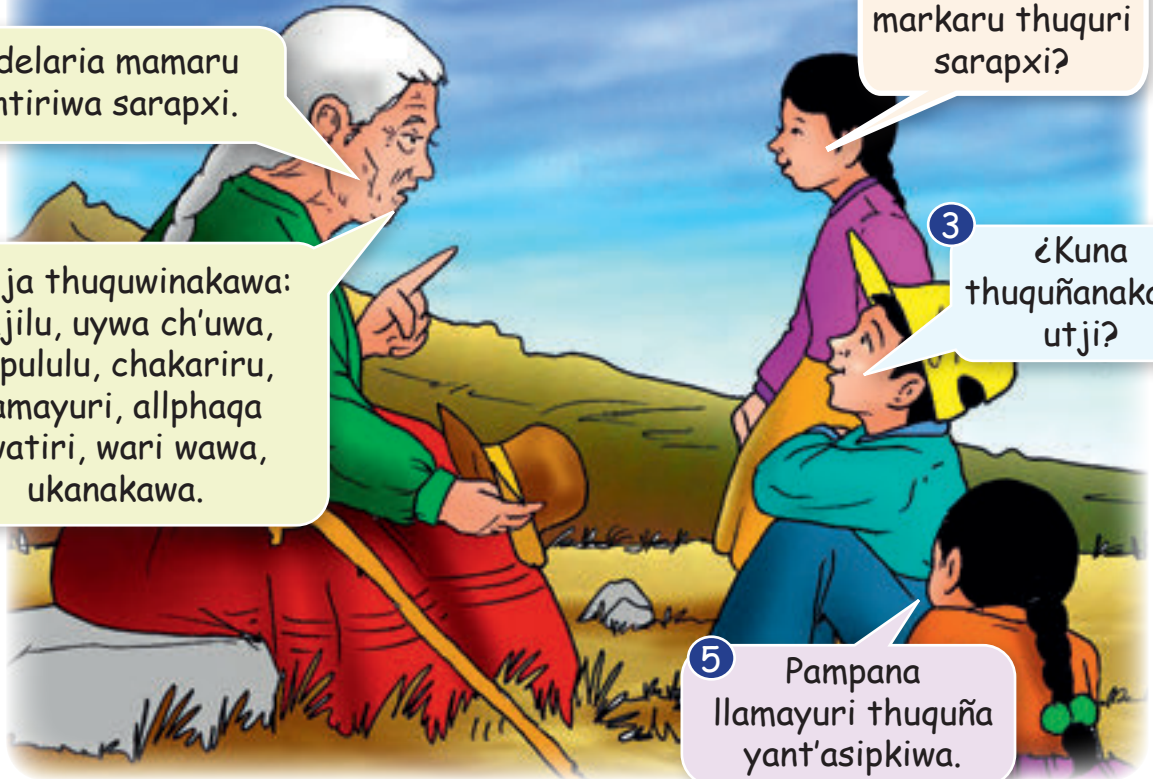

5 Pampana llamayuri thuqña yant'asipkiwa.



## 3. Jichhaxa Axura markata ayllunakapana thuqunakapa amtapxañani.



AYARCACHI  
LACACHI

CARNAVAL DE CCOTA

ZAMPOÑISTA NUEVO IMPACTO

ALPAQUEROS CULTA

LLAMAYURIS CHUSAMARCA

LLAMAYURIS CHUSAMARCA

CHACAREROS de CARITAMAYA

WIÑAY QUTA MARKA

VICUÑITAS DE COLLINI

NEGRITOS DE CCACCA

CHACAREROS de CHANCACHI

LLIPI PULIS DE CCAPALLA

KAJELOS DE YUNGUYO CH'AMAKA UTA

CHACAREROS FUERZA AYMARA YANAQUE



#### 4. Thuquña yant'awina arunaka arsuwi ist'apxañäni.

Kullakanaka kikiparu muyt'apxañäni.



Kikaparu kullakanaka, jilatanaka muyt'awapxma.

Jisa chachanakas kuskacht'asipxañäni.

Taqinisa atipañataki warurt'apxañäni.

Jisa, taqinisa wali ch'amampi warurt'apxañäni.



#### 5. Utana wilamasinakasampi aruskipapxañäni kuna isinakasa wakisi thuquñatakixa uka rixsupxañäni.



¿Kuna isinakasa thuquñataki munasi?

# Yatiqatasanaka uñacht'ayapxañäni



## ¿Kunjamsa yatiqatasa uñacht'ayapxañänixa?

Yatiqatasa sapa mayni amtapxañäni, ukata akhama  sich'impi sich'intapxañäni.

Kunanaksa yatiqatatxa uka uñakipaja	Janirawa yatiqkti 	Yatiqawtha 
1. Ayllusana utjawi tuqita yatxatañäni		
2. Markana utjawi tuqita yatxatañäni		
3. Julikuxa ayllupana sarnaqawipa yatiyi		
4. Sumitaxa markana sarnaqawipa yatiyi		
5. Aylluna thuquwinakapa uñt'apxañäni		
6. Candelaria mamana phunch'awinakapa yatxatapxañäni		

¿Kunsa lurapxañänixa? *Candelaria Mamana* uruphana thuquñataki pulliranaka ch'ukupxañäni.



## Pullira Ch'ukuña



1. ¿Kuna yänakasa wakisi pullira ch'ukuñataki?

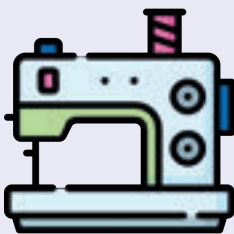

Ch'ukuña  
makina



Wayita  
sawuta



Tupaña chiqta, k'uchuña, thuru  
ch'ankha, jilu, sintillanaka



## 2. Wilamasisampi pullira ch'ukuña sarantayapxañäni.

1. Nayraqataxa sintillampi wayitampi **ch'ukthapiña.**



2. Ukaruxa sintilla jaqukipasa **ilwanaña.**



3. Tukuyu warirampi muytapa **ch'ukukipaña.**



4. Pullirana wastapa ch'ukuñataki **tupt'aña.**



5. Pullirana wiritillapa ch'ukusa **tukuyaña.**



6. Pullirana kulunapa chinuñataki **ch'ukkataña.**





3. Yatiqiri masinakasampi pullira tukuyata tuquñataki uchasipxañäni.

1. Nayraqataxa pullira ch'ukurinakjamawa amuyapxañäni.



Taqinisa aski amuyapxañäni luratasa amtasa.



2. Panini paniniwa luratasatha aruskipapxañäni.

1

Nayraqataxa sintillampi wayitampi ch'ukthapiña.



2

Ukaruxa sintilla jaqukipasa ilwanaña



3

Tukuyu warirampi muytapa ch'ukukipaña.

4

Pullirana wastapa ch'ukuñataki tupt'aña.



5

Pullirana wiritillapa ch'ukusa tukuyaña.

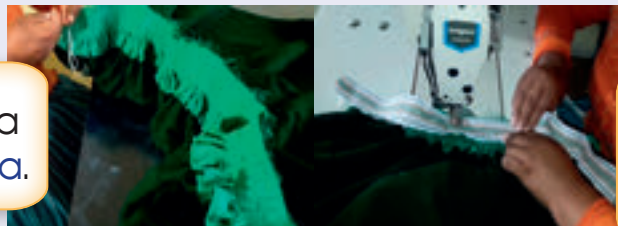

6

Pullirana kulunapa chinuñataki ch'ukkataña.



























# CARTA DEMOCRÁTICA INTERAMERICANA

## I La democracia y el sistema interamericano

### Artículo 1

Los pueblos de América tienen derecho a la democracia y sus gobiernos la obligación de promoverla y defenderla. La democracia es esencial para el desarrollo social, político y económico de los pueblos de las Américas.

### Artículo 2

El ejercicio efectivo de la democracia representativa es la base del estado de derecho y los regímenes constitucionales de los Estados Miembros de la Organización de los Estados Americanos. La democracia representativa se refuerza y profundiza con la participación permanente, ética y responsable de la ciudadanía en un marco de legalidad conforme al respectivo orden constitucional.

### Artículo 3

Son elementos esenciales de la democracia representativa, entre otros, el respeto a los derechos humanos y las libertades fundamentales; el acceso al poder y su ejercicio con sujeción al estado de derecho; la celebración de elecciones periódicas, libres, justas y basadas en el sufragio universal y secreto como expresión de la soberanía del pueblo; el régimen plural de partidos y organizaciones políticas; y la separación e independencia de los poderes públicos.

### Artículo 4

Son componentes fundamentales del ejercicio de la democracia la transparencia de las actividades gubernamentales, la probidad, la responsabilidad de los gobiernos en la gestión pública, el respeto por los derechos sociales y la libertad de expresión y de prensa. La subordinación constitucional de todas las instituciones del Estado a la autoridad civil legalmente constituida y el respeto al estado de derecho de todas las entidades y sectores de la sociedad son igualmente fundamentales para la democracia.

### Artículo 5

El fortalecimiento de los partidos y de otras organizaciones políticas es prioritario para la democracia. Se deberá prestar atención especial a la problemática derivada de los altos costos de las campañas electorales y al establecimiento de un régimen equilibrado y transparente de financiación de sus actividades.

### Artículo 6

La participación de la ciudadanía en las decisiones relativas a su propio desarrollo es un derecho y una responsabilidad. Es también una condición necesaria para el pleno y efectivo ejercicio de la democracia. Promover y fomentar diversas formas de participación fortalece la democracia.

## II La democracia y los derechos humanos

### Artículo 7

La democracia es indispensable para el ejercicio efectivo de las libertades fundamentales y los derechos humanos, en su carácter universal, indivisible e interdependiente, consagrados en las respectivas constituciones de los Estados y en los instrumentos interamericanos e internacionales de derechos humanos.

### Artículo 8

Cualquier persona o grupo de personas que consideren que sus derechos humanos han sido violados pueden interponer denuncias o peticiones ante el sistema interamericano de promoción y protección de los derechos humanos conforme a los procedimientos establecidos en el mismo. Los Estados Miembros reafirman su intención de fortalecer el sistema interamericano de protección de los derechos humanos para la consolidación de la democracia en el Hemisferio.

### Artículo 9

La eliminación de toda forma de discriminación, especialmente la discriminación de género, étnica y racial, y de las diversas formas de intolerancia, así como la promoción y protección de los derechos humanos de los pueblos indígenas y los migrantes y el respeto a la diversidad étnica, cultural y religiosa en las Américas, contribuyen al fortalecimiento de la democracia y la participación ciudadana.

### Artículo 10

La promoción y el fortalecimiento de la democracia requieren el ejercicio pleno y eficaz de los derechos de los trabajadores y la aplicación de normas laborales básicas, tal como están consagradas en la Declaración de la Organización Internacional del Trabajo (OIT) relativa a los Principios y Derechos Fundamentales en el Trabajo y su Seguimiento, adoptada en 1998, así como en otras convenciones básicas afines de la OIT. La democracia se fortalece con el mejoramiento de las condiciones laborales y la calidad de vida de los trabajadores del Hemisferio.

## III Democracia, desarrollo integral y combate a la pobreza

### Artículo 11

La democracia y el desarrollo económico y social son interdependientes y se refuerzan mutuamente.

### Artículo 12

La pobreza, el analfabetismo y los bajos niveles de desarrollo humano son factores que inciden negativamente en la consolidación de la democracia. Los Estados Miembros de la OEA se comprometen a adoptar y ejecutar todas las acciones necesarias para la creación de empleo productivo, la reducción de la pobreza y la erradicación de la pobreza extrema, teniendo en cuenta las diferentes realidades y condiciones económicas de los países del Hemisferio. Este compromiso común frente a los problemas del desarrollo y la pobreza también destaca la importancia de mantener los equilibrios macroeconómicos y el imperativo de fortalecer la cohesión social y la democracia.

### Artículo 13

La promoción y observancia de los derechos económicos, sociales y culturales son consustanciales al desarrollo integral, al crecimiento económico con equidad y a la consolidación de la democracia en los Estados del Hemisferio.

### Artículo 14

Los Estados Miembros acuerdan examinar periódicamente las acciones adoptadas y ejecutadas por la Organización encaminadas a fomentar el diálogo, la cooperación para el desarrollo integral y el combate a la pobreza en el Hemisferio, y tomar las medidas oportunas para promover estos objetivos.

### Artículo 15

El ejercicio de la democracia facilita la preservación y el manejo adecuado del medio ambiente. Es esencial que los Estados del Hemisferio implementen políticas y estrategias de protección del medio ambiente, respetando los diversos tratados y convenciones, para lograr un desarrollo sostenible en beneficio de las futuras generaciones.

### Artículo 16

La educación es clave para fortalecer las instituciones democráticas, promover el desarrollo del potencial humano y el alivio de la pobreza y fomentar un mayor entendimiento entre los pueblos. Para lograr estas metas, es esencial que una educación de calidad esté al alcance de todos, incluyendo a las niñas y las mujeres, los habitantes de las zonas rurales y las personas que pertenecen a las minorías.

## IV Fortalecimiento y preservación de la institucionalidad democrática

### Artículo 17

Cuando el gobierno de un Estado Miembro considere que está en riesgo su proceso político institucional democrático o su legítimo ejercicio del poder, podrá recurrir al Secretario General o al Consejo Permanente a fin de solicitar asistencia para el fortalecimiento y preservación de la institucionalidad democrática.

### Artículo 18

Cuando en un Estado Miembro se produzcan situaciones que pudieran afectar el desarrollo del proceso político institucional democrático o el legítimo ejercicio del poder, el Secretario General o el Consejo Permanente podrá, con el consentimiento previo del gobierno afectado, disponer visitas y otras gestiones con la finalidad de hacer un análisis de la situación. El Secretario General elevará un informe al Consejo Permanente, y éste realizará una apreciación colectiva de la situación y, en caso necesario, podrá adoptar decisiones dirigidas a la preservación de la institucionalidad democrática y su fortalecimiento.

### Artículo 19

Basado en los principios de la Carta de la OEA y con sujeción a sus normas, y en concordancia con la cláusula democrática contenida en la Declaración de la ciudad de Quebec, la ruptura del orden democrático o una alteración del orden constitucional que afecte gravemente el orden democrático en un Estado Miembro constituye, mientras persista, un obstáculo insuperable para la participación de su gobierno en las sesiones de la Asamblea General, de la Reunión de Consulta, de los Consejos de la Organización y de las conferencias especializadas, de las comisiones, grupos de trabajo y demás órganos de la Organización.

### Artículo 20

En caso de que en un Estado Miembro se produzca una alteración del orden constitucional que afecte gravemente su orden democrático, cualquier Estado Miembro o el Secretario General podrá solicitar la convocatoria inmediata del Consejo Permanente para realizar una apreciación colectiva de la situación y adoptar las decisiones que estime conveniente. El Consejo Permanente, según la situación, podrá disponer la realización de las gestiones diplomáticas necesarias, incluidos los buenos oficios, para promover la normalización de la institucionalidad democrática. Si las gestiones diplomáticas resultaren infructuosas o si la urgencia del caso lo aconsejare, el Consejo Permanente convocará de inmediato un período extraordinario de sesiones de la Asamblea General para que ésta adopte las decisiones que estime apropiadas, incluyendo gestiones diplomáticas, conforme a la Carta de la Organización, el derecho internacional y las disposiciones de la presente Carta Democrática. Durante el proceso se realizarán las gestiones diplomáticas necesarias, incluidos los buenos oficios, para promover la normalización de la institucionalidad democrática.

### Artículo 21

Cuando la Asamblea General, convocada a un período extraordinario de sesiones, constate que se ha producido la ruptura del orden democrático en un Estado Miembro y que las gestiones diplomáticas han sido infructuosas, conforme a la Carta de la OEA tomará la decisión de suspender a dicho Estado Miembro del ejercicio de su derecho de participación en la OEA con el voto afirmativo de los dos tercios de los Estados Miembros. La suspensión entrará en vigor de inmediato.

El Estado Miembro que hubiera sido objeto de suspensión deberá continuar observando el cumplimiento de sus obligaciones como miembro de la Organización, en particular en materia de derechos humanos.

Adoptada la decisión de suspender a un gobierno, la Organización mantendrá sus gestiones diplomáticas para el restablecimiento de la democracia en el Estado Miembro afectado.

### Artículo 22

Una vez superada la situación que motivó la suspensión, cualquier Estado Miembro o el Secretario General podrá proponer a la Asamblea General el levantamiento de la suspensión. Esta decisión se adoptará por el voto de los dos tercios de los Estados Miembros, de acuerdo con la Carta de la OEA.

## V La democracia y las misiones de observación electoral

### Artículo 23

Los Estados Miembros son los responsables de organizar, llevar a cabo y garantizar procesos electorales libres y justos. Los Estados Miembros, en ejercicio de su soberanía, podrán solicitar a la OEA asesoramiento o asistencia para el fortalecimiento y desarrollo de sus instituciones y procesos electorales, incluido el envío de misiones preliminares para ese propósito.

### Artículo 24

Las misiones de observación electoral se llevarán a cabo por solicitud del Estado Miembro interesado. Con tal finalidad, el gobierno de dicho Estado y el Secretario General celebrarán un convenio que determine el alcance y la cobertura de la misión de observación electoral de que se trate. El Estado Miembro deberá garantizar las condiciones de seguridad, libre acceso a la información y amplia cooperación con la misión de observación electoral. Las misiones de observación electoral se realizarán de conformidad con los principios y normas de la OEA. La Organización deberá asegurar la eficacia e independencia de estas misiones, para lo cual se las dotará de los recursos necesarios. Las mismas se realizarán de forma objetiva, imparcial y transparente, y con la capacidad técnica apropiada. Las misiones de observación electoral presentarán oportunamente al Consejo Permanente, a través de la Secretaría General, los informes sobre sus actividades.

### Artículo 25

Las misiones de observación electoral deberán informar al Consejo Permanente, a través de la Secretaría General, si no existiesen las condiciones necesarias para la realización de elecciones libres y justas. La OEA podrá enviar, con el acuerdo del Estado interesado, misiones especiales a fin de contribuir a crear o mejorar dichas condiciones.

## VI Promoción de la cultura democrática

### Artículo 26

La OEA continuará desarrollando programas y actividades dirigidos a promover los principios y prácticas democráticas y fortalecer la cultura democrática en el Hemisferio, considerando que la democracia es un sistema de vida fundado en la libertad y el mejoramiento económico, social y cultural de los pueblos. La OEA mantendrá consultas y cooperación continua con los Estados Miembros, tomando en cuenta los aportes de organizaciones de la sociedad civil que trabajen en esos ámbitos.

### Artículo 27

Los programas y actividades se dirigirán a promover la gobernabilidad, la buena gestión, los valores democráticos y el fortalecimiento de la institucionalidad política y de las organizaciones de la sociedad civil. Se prestará atención especial al desarrollo de programas y actividades para la educación de la niñez y la juventud como forma de asegurar la permanencia de los valores democráticos, incluidas la libertad y la justicia social.

### Artículo 28

Los Estados promoverán la plena e igualitaria participación de la mujer en las estructuras políticas de sus respectivos países como elemento fundamental para la promoción y ejercicio de la cultura democrática.

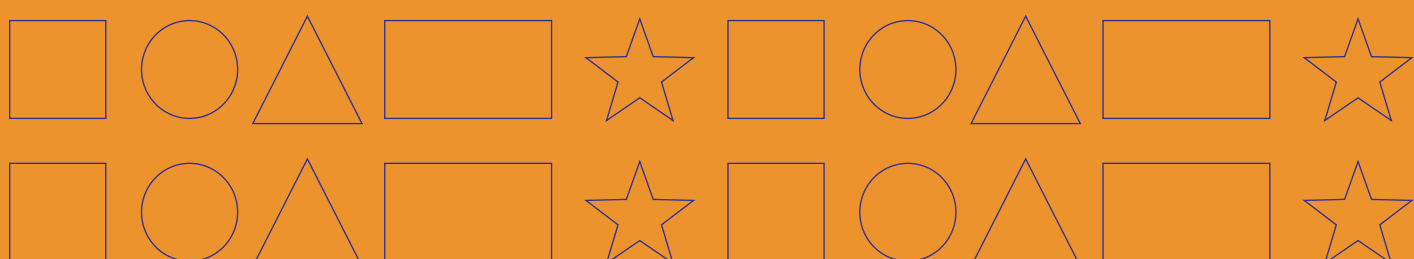
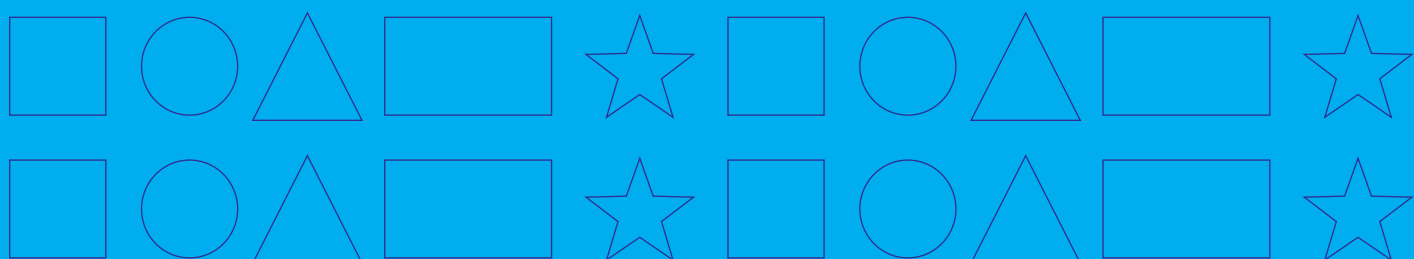
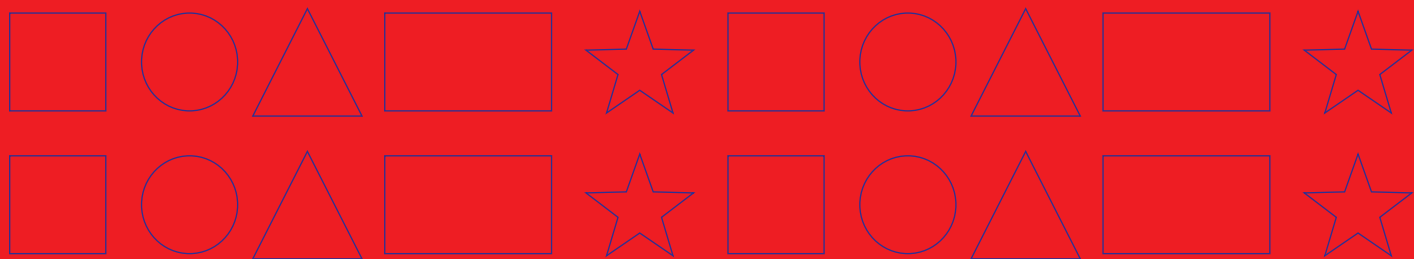
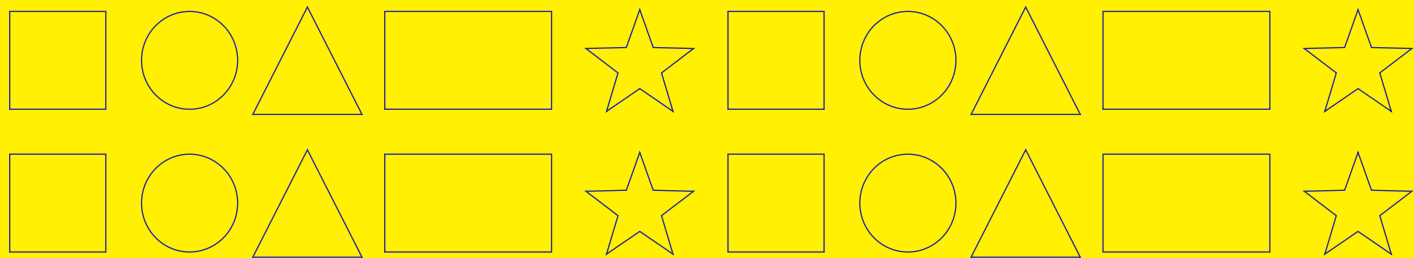



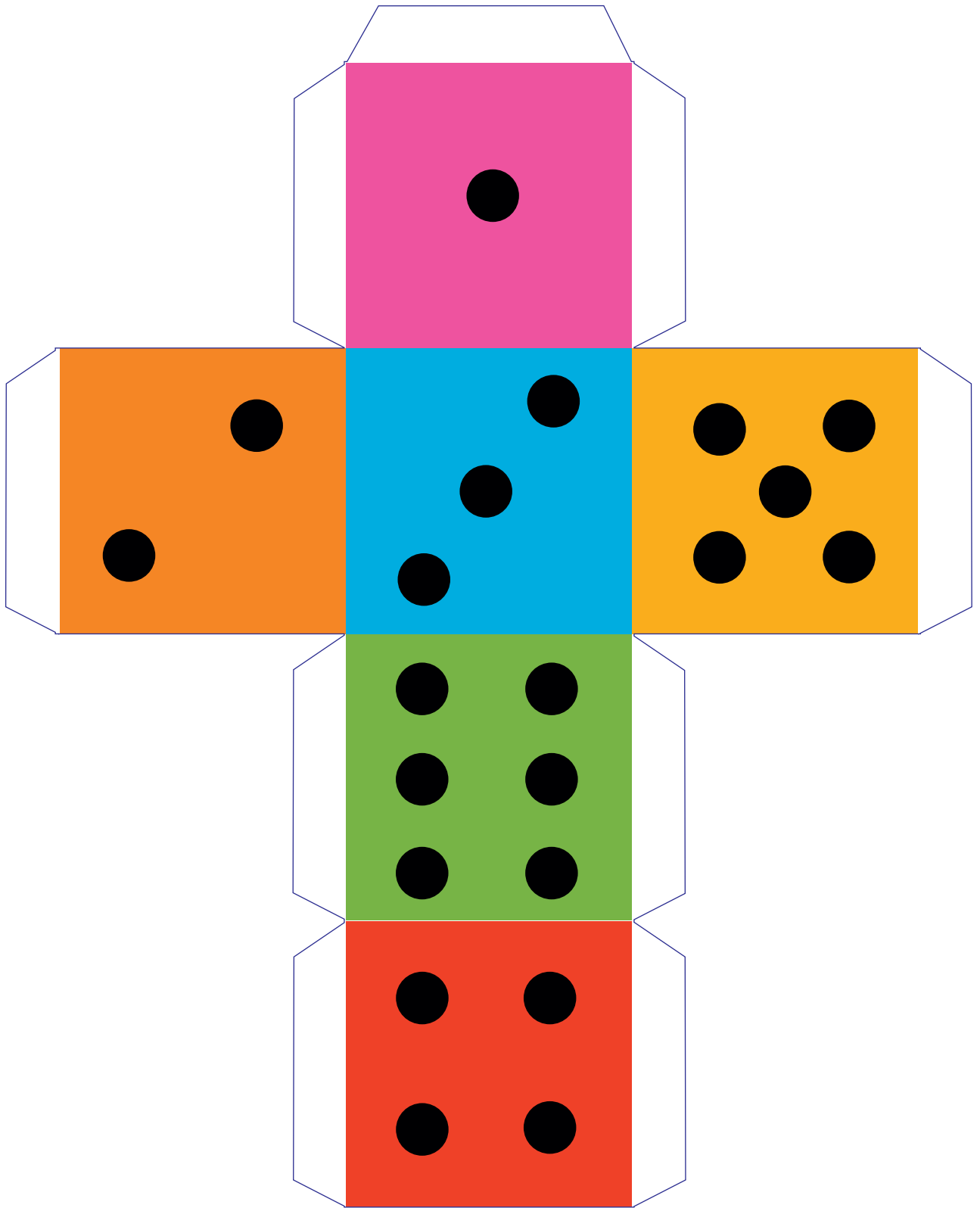









# El Acuerdo Nacional

El 22 de julio de 2002, los representantes de las organizaciones políticas, religiosas, del Gobierno y de la sociedad civil firmaron el compromiso de trabajar, todos, para conseguir el bienestar y desarrollo del país. Este compromiso es el Acuerdo Nacional.

El Acuerdo persigue cuatro objetivos fundamentales. Para alcanzarlos, todos los peruanos de buena voluntad tenemos, desde el lugar que ocupemos o el rol que desempeñemos, el deber y la responsabilidad de decidir, ejecutar, vigilar o defender los compromisos asumidos. Estos son tan importantes que serán respetados como políticas permanentes para el futuro.

Por esta razón, como niños, niñas, adolescentes o adultos, ya sea como estudiantes o trabajadores, debemos promover y fortalecer acciones que garanticen el cumplimiento de esos cuatro objetivos que son los siguientes:

## **1. Democracia y Estado de Derecho**

La justicia, la paz y el desarrollo que necesitamos los peruanos sólo se pueden dar si conseguimos una verdadera democracia. El compromiso del Acuerdo Nacional es garantizar una sociedad en la que los derechos son respetados y los ciudadanos viven seguros y expresan con libertad sus opiniones a partir del diálogo abierto y enriquecedor; decidiendo lo mejor para el país.

## **2. Equidad y Justicia Social**

Para poder construir nuestra democracia, es necesario que cada una de las personas que

conformamos esta sociedad, nos sintamos parte de ella. Con este fin, el Acuerdo promoverá el acceso a las oportunidades económicas, sociales, culturales y políticas. Todos los peruanos tenemos derecho a un empleo digno, a una educación de calidad, a una salud integral, a un lugar para vivir. Así, alcanzaremos el desarrollo pleno.

## **3. Competitividad del País**

Para afianzar la economía, el Acuerdo se compromete a fomentar el espíritu de competitividad en las empresas, es decir, mejorar la calidad de los productos y servicios, asegurar el acceso a la formalización de las pequeñas empresas y sumar esfuerzos para fomentar la colocación de nuestros productos en los mercados internacionales.

## **4. Estado Eficiente, Transparente y Descentralizado**

Es de vital importancia que el Estado cumpla con sus obligaciones de manera eficiente y transparente para ponerse al servicio de todos los peruanos. El Acuerdo se compromete a modernizar la administración pública, desarrollar instrumentos que eliminen la corrupción o el uso indebido del poder. Asimismo, descentralizar el poder y la economía para asegurar que el Estado sirva a todos los peruanos sin excepción. Mediante el Acuerdo Nacional nos comprometemos a desarrollar maneras de controlar el cumplimiento de estas políticas de Estado, a brindar apoyo y difundir constantemente sus acciones a la sociedad en general.

# SÍMBOLOS DE LA PATRIA



BANDERA



HIMNO NACIONAL



ESCUDO

## Declaración Universal de los Derechos Humanos

El 10 de diciembre de 1948, la Asamblea General de las Naciones Unidas aprobó y proclamó la Declaración Universal de Derechos Humanos, cuyos artículos figuran a continuación:

**Artículo 1.-** Todos los seres humanos nacen libres e iguales en dignidad y derechos y (...) deben comportarse fraternalmente los unos con los otros.

**Artículo 2.-** Toda persona tiene todos los derechos y libertades proclamados en esta Declaración, sin distinción alguna de raza, color, sexo, idioma, religión, opinión política o de cualquier otra índole, origen nacional o social, posición económica, nacimiento o cualquier otra condición. Además, no se hará distinción alguna fundada en la condición política, jurídica o internacional del país o territorio de cuya jurisdicción dependa una persona (...).

**Artículo 3.-** Todo individuo tiene derecho a la vida, a la libertad y a la seguridad de su persona.

**Artículo 4.-** Nadie estará sometido a esclavitud ni a servidumbre; la esclavitud y la trata de esclavos están prohibidas en todas sus formas.

**Artículo 5.-** Nadie será sometido a torturas ni a penas o tratos crueles, inhumanos o degradantes.

**Artículo 6.-** Todo ser humano tiene derecho, en todas partes, al reconocimiento de su personalidad jurídica.

**Artículo 7.-** Todos son iguales ante la ley y tienen, sin distinción, derecho a igual protección de la ley. Todos tienen derecho a igual protección contra toda discriminación que infrinja esta Declaración (...).

**Artículo 8.-** Toda persona tiene derecho a un recurso efectivo, ante los tribunales nacionales competentes, que la ampare contra actos que violen sus derechos fundamentales (...).

**Artículo 9.-** Nadie podrá ser arbitrariamente detenido, preso ni desterrado.

**Artículo 10.-** Toda persona tiene derecho, en condiciones de plena igualdad, a ser oída públicamente y con justicia por un tribunal independiente e imparcial, para la determinación de sus derechos y obligaciones o para el examen de cualquier acusación contra ella en materia penal.

**Artículo 11.-**

1. Toda persona acusada de delito tiene derecho a que se presuma su inocencia mientras no se pruebe su culpabilidad (...).

2. Nadie será condenado por actos u omisiones que en el momento de cometerse no fueron delictivos según el Derecho nacional o internacional. Tampoco se impondrá pena más grave que la aplicable en el momento de la comisión del delito.

**Artículo 12.-** Nadie será objeto de injerencias arbitrarias en su vida privada, su familia, su domicilio o su correspondencia, ni de ataques a su honra o a su reputación. Toda persona tiene derecho a la protección de la ley contra tales injerencias o ataques.

**Artículo 13.-**

1. Toda persona tiene derecho a circular libremente y a elegir su residencia en el territorio de un Estado.

2. Toda persona tiene derecho a salir de cualquier país, incluso del propio, y a regresar a su país.

**Artículo 14.-**

1. En caso de persecución, toda persona tiene derecho a buscar asilo, y a disfrutar de él, en cualquier país.

2. Este derecho no podrá ser invocado contra una acción judicial realmente originada por delitos comunes o por actos opuestos a los propósitos y principios de las Naciones Unidas.

**Artículo 15.-**

1. Toda persona tiene derecho a una nacionalidad.

2. A nadie se privará arbitrariamente de su nacionalidad ni del derecho a cambiar de nacionalidad.

**Artículo 16.-**

1. Los hombres y las mujeres, a partir de la edad núbil, tienen derecho, sin restricción alguna por motivos de raza, nacionalidad o religión, a casarse y fundar una familia (...).

2. Sólo mediante libre y pleno consentimiento de los futuros esposos podrá contraerse el matrimonio.

3. La familia es el elemento natural y fundamental de la sociedad y tiene derecho a la protección de la sociedad y del Estado.

**Artículo 17.-**

1. Toda persona tiene derecho a la propiedad, individual y colectivamente.

2. Nadie será privado arbitrariamente de su propiedad.

**Artículo 18.-** Toda persona tiene derecho a la libertad de pensamiento, de conciencia y de religión (...).

**Artículo 19.-** Todo individuo tiene derecho a la libertad de opinión y de expresión (...).

**Artículo 20.-**

1. Toda persona tiene derecho a la libertad de reunión y de asociación pacíficas.

2. Nadie podrá ser obligado a pertenecer a una asociación.

**Artículo 21.-**

1. Toda persona tiene derecho a participar en el gobierno de su país, directamente o por medio de representantes libremente escogidos.

2. Toda persona tiene el derecho de acceso, en condiciones de igualdad, a las funciones públicas de su país.

3. La voluntad del pueblo es la base de la autoridad del poder público; esta voluntad se expresará mediante elecciones auténticas que habrán de celebrarse periódicamente, por sufragio universal e igual y por voto secreto u otro procedimiento equivalente que garantice la libertad del voto.

**Artículo 22.-** Toda persona (...) tiene derecho a la seguridad social, y a obtener (...) habida cuenta de la organización y los recursos de cada Estado, la satisfacción de los derechos económicos, sociales y culturales, indispensables a su dignidad y al libre desarrollo de su personalidad.

**Artículo 23.-**

1. Toda persona tiene derecho al trabajo, a la libre elección de su trabajo, a condiciones equitativas y satisfactorias de trabajo y a la protección contra el desempleo.

2. Toda persona tiene derecho, sin discriminación alguna, a igual salario por trabajo igual.

3. Toda persona que trabaja tiene derecho a una remuneración equitativa y satisfactoria, que le asegure, así como a su familia, una existencia conforme a la dignidad humana y que será completada, en caso necesario, por cualesquiera otros medios de protección social.

4. Toda persona tiene derecho a fundar sindicatos y a sindicarse para la defensa de sus intereses.

**Artículo 24.-**

Toda persona tiene derecho al descanso, al disfrute del tiempo libre, a una limitación razonable de la duración del trabajo y a vacaciones periódicas pagadas.

**Artículo 25.-**

1. Toda persona tiene derecho a un nivel de vida adecuado que le asegure, así como a su familia, la salud y el bienestar, y en especial la alimentación, el vestido, la vivienda, la asistencia médica y los servicios sociales necesarios; tiene asimismo derecho a los seguros en caso de desempleo, enfermedad, invalidez, vejez u otros casos de pérdida de sus medios de subsistencia por circunstancias independientes de su voluntad.

2. La maternidad y la infancia tienen derecho a cuidados y asistencia especiales. Todos los niños, nacidos de matrimonio o fuera de matrimonio, tienen derecho a igual protección social.

**Artículo 26.-**

1. Toda persona tiene derecho a la educación. La educación debe ser gratuita, al menos en lo concerniente a la instrucción elemental y fundamental. La instrucción elemental será obligatoria. La instrucción técnica y profesional habrá de ser generalizada; el acceso a los estudios superiores será igual para todos, en función de los méritos respectivos.

2. La educación tendrá por objeto el pleno desarrollo de la personalidad humana y el fortalecimiento del respeto a los derechos humanos y a las libertades fundamentales; favorecerá la comprensión, la tolerancia y la amistad entre todas las naciones y todos los grupos étnicos o religiosos; y promoverá el desarrollo de las actividades de las Naciones Unidas para el mantenimiento de la paz.

3. Los padres tendrán derecho preferente a escoger el tipo de educación que habrá de darse a sus hijos.

**Artículo 27.-**

1. Toda persona tiene derecho a tomar parte libremente en la vida cultural de la comunidad, a gozar de las artes y a participar en el progreso científico y en los beneficios que de él resulten.

2. Toda persona tiene derecho a la protección de los intereses morales y materiales que le correspondan por razón de las producciones científicas, literarias o artísticas de que sea autora.

**Artículo 28.-** Toda persona tiene derecho a que se establezca un orden social e internacional en el que los derechos y libertades proclamados en esta Declaración se hagan plenamente efectivos.

**Artículo 29.-**

1. Toda persona tiene deberes respecto a la comunidad (...).

2. En el ejercicio de sus derechos y en el disfrute de sus libertades, toda persona estará solamente sujeta a las limitaciones establecidas por la ley con el único fin de asegurar el reconocimiento y el respeto de los derechos y libertades de los demás, y de satisfacer las justas exigencias de la moral, del orden público y del bienestar general en una sociedad democrática.

3. Estos derechos y libertades no podrán, en ningún caso, ser ejercidos en oposición a los propósitos y principios de las Naciones Unidas.

**Artículo 30.-** Nada en esta Declaración podrá interpretarse en el sentido de que confiere derecho alguno al Estado, a un grupo o a una persona, para emprender y desarrollar actividades (...) tendientes a la supresión de cualquiera de los derechos y libertades proclamados en esta Declaración.

DISTRIBUIDO GRATUITAMENTE POR EL MINISTERIO DE EDUCACIÓN  
PROHIBIDA SU VENTA